

TFW Monitoring Program

METHOD MANUAL

for the

SALMONID SPAWNING HABITAT AVAILABILITY SURVEY

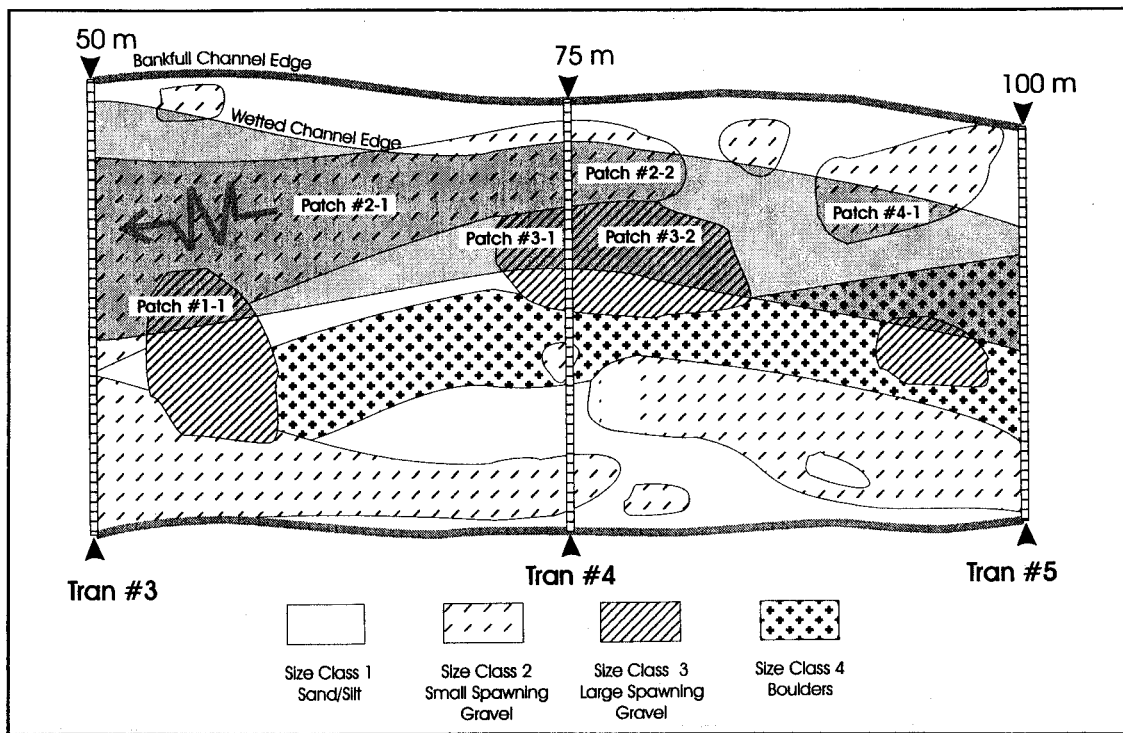

by:

Dave Schuett-Hames

Allen E. Pleus

Devin Smith



November 1999



*Citation*

Schuett-Hames, D., A.E. Pleus, and D. Smith. 1999. TFW Monitoring Program method manual for the salmonid spawning habitat availability survey. Prepared for the Washington State Dept. of Natural Resources under the Timber, Fish, and Wildlife Agreement. TFW-AM9-99-007. DNR # 109. November.

**Abstract**

The TFW Monitoring Program method manual for the Salmonid Spawning Habitat Availability (SHA) Survey provides a standard method for the assessment and monitoring of available salmonid spawning habitat. The criteria used to determine spawning habitat includes substrate particle size, substrate depth, water depth, water velocity, and surface area coverage. The SHA Survey has two methods for estimating the amount of spawning habitat on the TFW stream segment scale. The transect method uses dominant substrate information collected along systematically placed transects to estimate the total surface area of potential spawning habitat within the bankfull and wetted channels. The patch method provides detailed information on the surface area and distribution of individual spawning habitat patches within the wetted channel. Monitoring objectives and timing of surveys are used to select whether one or both survey methods are applied.

The remainder of the introduction section describes the purpose of the SHA Survey, reviews scientific background information, and describes the cooperator services provided by the TFW Monitoring Program. Following the introduction, sections are presented in order of survey application including: study design, pre-survey preparation, stream discharge, survey methods, post-survey documentation, data management, and references. An extensive appendix is also provided that includes field form copy masters, examples of completed field forms, a field code sheet, data management examples, and a standard field and vehicle gear checklist.

**TFW Monitoring Program**  
Northwest Indian Fisheries Commission  
6730 Martin Way East  
Olympia, Washington 98516

Ph: (360)438-1180  
Fax: (360)753-8659

Internet:  
<http://www.nwifc.wa.gov>

**Washington Dept. of Natural Resources**  
Forest Practices Div.: CMER Documents  
P.O. Box 47014  
Olympia, Washington 98504-7014

Ph: (360)902-1400

## The Authors

**Dave Schuett-Hames** is the TFW Monitoring Program Coordinator/Biologist at the Northwest Indian Fisheries Commission. He received a B.S. degree in biology (1976) and an M.E.S. degree (1996) from the Evergreen State College. He worked for 12 years as a fish habitat biologist for the Lummi Nation and the Squaxin Island Tribe. He joined the program as coordinator in 1992. E-mail: dschuett@nwifc.wa.gov

**Allen E. Pleus** is the TFW Monitoring Program Lead Training and Quality Assurance Biologist at the Northwest Indian Fisheries Commission. He received a B.A. degree in communications (1985) and an M.E.S. degree (1995) from the Evergreen State College. He began working for the program in 1991. E-mail: apleus@nwifc.wa.gov

**Devin Smith** is a biologist for the Salmon and Steelhead Habitat Inventory and Assessment Project (SSHIAP) at the Northwest Indian Fisheries Commission. He received a B.A. degree (1993) in Psychology from Occidental College and an M.E.S. degree (1996) with a focus on watershed science from the Evergreen State College. He worked for the TFW Monitoring Program from 1995 to 1998. E-mail: dsmith@nwifc.wa.gov

## Acknowledgements

The development of this document was funded by the Timber-Fish-Wildlife (TFW) Cooperative Monitoring, Evaluation, and Research (CMER) committee with funding provided by the Washington Department of Natural Resources. Special thanks to Sue Madsen of R2 Resource Consultants, Inc. for technical feedback on instruction and field application. TFW Monitoring Program (TFW-MP) staff member Amy Morgan contributed a great many hours reviewing and editing drafts and helping with production. Northwest Indian Fisheries Commission (NWIFC) staff members including Tony Meyer, Sheila McCloud, Debbie Preston, Mike Messenger, and Craig Carns have provided valuable proofing, layout, and production assistance. Finally, thanks to the TFW Monitoring Advisory Group members including Randy McIntosh and Jeff Light (Co-chairs) for their support and guidance.

## Copying of the TFW Manual

All TFW Monitoring Program method manuals are public documents. No permission is required to copy any part. The only requirement is that they be properly cited. Copies of the method manuals are available from the TFW Monitoring Program or the Washington Dept. of Natural Resources (see Abstract page for contact information).

*Manual cover, method illustrations, field forms, and layout design by Allen Pleus unless otherwise noted.*

## Contents

|          |  |           |
|----------|--|-----------|
| <b>1</b> | <b>Introduction</b> .....  | <b>1</b>  |
| 1.1      | Purpose .....  | 1         |
| 1.2      | Background .....   | 2         |
| 1.2.1    | Distribution of Spawning Habitat Within Watersheds and Stream Segments ..... | 2         |
| 1.2.2    | Characteristics Used to Select Spawning Habitat .....                        | 2         |
| 1.2.3    | Salmonid Body Size and Spawning Habitat Gravel Size Class Relationship ..... | 3         |
| 1.3      | Cooperator Services .....  | 3         |
| <b>2</b> | <b>Study Design</b> .....  | <b>4</b>  |
| 2.1      | Identifying Monitoring Segments .....  | 4         |
| 2.2      | Survey Method Options .....  | 4         |
| 2.3      | Timing of Surveys .....  | 5         |
| 2.4      | Study Design Based on Project Objectives .....                               | 5         |
| 2.5      | Survey Modifications Options .....   | 6         |
| 2.6      | Pre-Season Crew Training and Quality Assurance Review .....                  | 7         |
| <b>3</b> | <b>Pre-Survey Preparation</b> .....  | <b>8</b>  |
| 3.1      | Survey Equipment .....   | 8         |
| 3.2      | Survey Materials .....   | 8         |
| 3.2.1    | SHA HEADER INFORMATION" Form 9.0 .....                                       | 9         |
| 3.2.2    | SHA CHANNEL WIDTH DATA" Form 9.1 .....                                       | 10        |
|          | SHA TRANSECT DATA" Form 9.2, and<br>SHA PATCH DATA" Form 9.3                 |           |
| 3.2.3    | SHA Criteria and Code Field Sheet .....                                      | 11        |
| <b>4</b> | <b>Stream Discharge Measurement</b> .....                                    | <b>12</b> |
| <b>5</b> | <b>SHA Survey Methods</b> .....  | <b>13</b> |
| 5.1      | Channel Width Measurement Procedure .....                                    | 13        |
| 5.2      | SHA Transect Survey Procedure .....  | 17        |
| 5.3      | SHA Patch Survey Procedure .....   | 21        |
| <b>6</b> | <b>Post-Survey Documentation</b> .....                                       | <b>26</b> |
| 6.1      | Finalizing Survey Forms .....  | 26        |
| 6.2      | Error Checking .....   | 26        |
| <b>7</b> | <b>Data Management</b> .....   | <b>27</b> |
| 7.1      | Data Preparation .....   | 27        |
| 7.2      | Data Processing, Products, and Archiving .....                               | 27        |
| 7.3      | Data Analysis and Interpretation .....                                       | 28        |
| 7.3.1    | SHA Transect Survey Segment Summary Report .....                             | 28        |
| 7.3.2    | SHA Patch Survey Segment Summary Report .....                                | 28        |
| 7.3.3    | Data Interpretation .....  | 28        |

**Contents (cont.)**

**8**    **References** ..... 30

**9**    **Appendixes** ..... 33

      Appendix A: Form 9.0, 9.1, 9.2, and 9.3 Copy Masters

      Appendix B: Examples of Completed Forms 9.0, 9.1, 9.2, and 9.3

      Appendix C: SHA Criteria and Code Field Sheet Copy Master

      Appendix D: Data Management Examples

      Appendix E: Standard Field and Vehicle Gear Checklist Copy Master

# Salmonid Spawning Habitat Availability Survey

## 1. Introduction



The TFW Monitoring Program method manual for the Salmonid Spawning Habitat Availability (SHA) Survey provides a standard method for the assessment and monitoring of available salmonid spawning habitat. The criteria used to determine spawning habitat includes substrate particle size, substrate depth, water depth, water velocity, and surface area coverage. The SHA Survey has two methods for estimating the amount of spawning habitat on the TFW stream segment scale. The transect method uses dominant substrate information collected along systematically placed transects to estimate the total surface area of potential spawning habitat within the bankfull and wetted channels. The patch method provides detailed information on the surface area and distribution of individual spawning habitat patches within the wetted channel. Monitoring objectives and timing of surveys are used to select whether one or both survey methods are applied.

The remainder of the introduction section describes the purpose of the SHA Survey, reviews scientific background information, and describes the cooperator services provided by the TFW Monitoring Program. Following the introduction, sections are presented in order of survey application including: study design, pre-survey preparation, stream discharge, survey methods, post-survey documentation, data management, and references. An extensive appendix is also provided that includes field form copy masters, examples of completed field forms, a field code sheet, data management examples, and a standard field and vehicle gear checklist.

### 1.1 Purpose

The Timber-Fish-Wildlife Monitoring Program (TFW-MP) provides standard methods for monitoring changes and trends in salmonid spawning habitat availability. The SHA Survey method has been approved by TFW's Cooperative Monitoring, Evaluation and Research Committee (CMER) and is accepted as a standard method for monitoring on forest lands in Washington state by tribal governments, state natural resource agencies, timber companies, environmental organizations, and others. The purpose of the SHA Survey is to:

1. Assess and monitor the availability of potential spawning habitat within the bankfull channel.
2. Assess and monitor the availability of actual spawning habitat in the wetted channel at a discharge representative of the spawning season.
3. Interpret spawning habitat availability in the context of channel conditions and watershed

The relative abundance of spawning habitat is used as an indicator of resource condition for individual monitoring projects and in the Watershed Analysis Fish Habitat Assessment process (WFPB, 1996). In segments where spawning habitat is scarce, information on hydrology, sediment supply, channel conditions, and human activities is examined to determine why. The survey does not attempt to document or predict actual survival to emergence, because that objective would require research of an intensity impractical for management purposes. Nor is it oriented towards the requirements of any particular salmonid species, as species may vary within and between stream segments around the state.

## 1.2 Background

This section provides a review of the scientific literature used as the basis for the SHA Survey. Background information includes distribution of spawning habitat within watersheds and stream segments and characteristics used to select spawning habitat.

### 1.2.1 *Distribution of Spawning Habitat Within Watersheds and Stream Segments*

The distribution of spawning habitat in a stream system is related to the physical characteristics of the stream channel and the watershed. Factors such as geology (Duncan and Ward, 1985; Crisp and Carling, 1989), sediment supply (Collins and Dunne, 1990; Buffington, 1995), stream power (Benda et al., 1992; Buffington, 1995), and obstructions such as boulders and LWD (Keller and Swanson, 1979; Kondolf et al., 1991; Buffington, 1995) affect the abundance, particle size distribution, and stability of spawning gravel deposits.

Within a stream reach, the area available for spawning can limit the number of eggs successfully deposited in the gravel, potentially limiting the size of the next generation when spawning habitat is limited (McNeil, 1964; Allen, 1969; McFadden, 1969; Schroder, 1973; Semenchenko, 1989). This is most likely to affect populations of pink, chum and sockeye that are typically not limited by food and space in fresh water and often return to spawn in large numbers (McFadden, 1969).

Land-use activities and catastrophic events affect the distribution of spawning habitat by changing the type or amount of sediment delivered to a stream system or altering patterns of sediment transport and storage within stream channels. Spawning habitat can be reduced by activities such as bank armoring and stabilization that restrict recruitment of gravel to stream channels, construction of dams that block downstream gravel movement, or gravel mining and stream channelization projects that remove gravel from channels (Collins and Dunne, 1990, Kondolf and Swanson, 1993). Large inputs of fine sediment from logging roads can bury spawning gravel (Platts and Megahan, 1975; Platts et al., 1989). Splash dam operations and debris torrents can scour away spawning gravel and obstructions such as large woody debris, reducing potential gravel storage sites (Wendler and Deschamps, 1955; Keller and Swanson, 1979).

### 1.2.2 *Characteristics Used to Select Spawning Habitat*

The characteristics of spawning sites vary extensively between species and among stocks of the same species (Miller and Brannon, 1982). Studies indicate that a combination of factors are evaluated (Chambers, et al., 1955), and there is a relatively wide range of acceptable conditions for most species (Hunter, 1973). Characteristics that can influence site selection include substrate size, water velocity, water depth, bed compaction, gravel permeability, suitable surface and sub-surface flow conditions, dissolved oxygen, water temperature and proximity to cover (Burner, 1951; Briggs, 1953; Chambers et al, 1955; Vaux, 1962; Hoopes 1972; Hunter, 1973; Heard, 1991; Kondolf and Wolman, 1993; Leman, 1993).

Factors such as substrate size, water depth, and water velocity appear to limit where a female is physically able to construct a redd. Body size and stamina determine the size of particles that can be moved, the ability to work in fast water, and maneuverability in shallow water. If there is extensive variation in the size of individual members of a population, differences in velocity, minimum depth, and substrate preferences may be nearly as great between members of the population as between different stocks or species (Hunter, 1973).

Within the realm of sites where spawning is physically possible, salmonids often select sites where sub-surface flow conditions, permeability and dissolved oxygen are favorable for the survival of the eggs and alevin, and avoid locations with compacted beds and low permeability (Burner, 1951). Locations such as pool tailouts (riffle crests), where the interchange of surface water into the gravel is enhanced, are favored locations for spawning (Briggs, 1953; Hoopes, 1972; Hunter, 1973). Some species such as chum, brook trout, sockeye, and rainbow trout prefer sites with up-welling groundwater (Webster and Eiriksdottir, 1976; Sowden and Power, 1985; Burgner, 1991; Leman, 1993; Curry et al., 1994). Other site selection criteria, such as proximity to cover and suitable holding habitat enhance the survival of the female.

The proximity to habitat needed by young fish after incubation can also be a factor in site selection. This strategy reduces juvenile mortality by providing quick access to food and cover resources. For example, coho



often spawn in tributaries throughout a river system, allowing their young to disperse and rear in stream channels of various sizes. Sockeye often restrict spawning to inlet or outlet streams of the rearing lakes needed by their young.

*1.2.3 Salmonid Body Size and Spawning Habitat Gravel Size Class Relationship*

In the SHA Survey, the most important parameter for identifying spawning habitat in the stream channel is dominant substrate particle size. The two spawning gravel size classes used in this survey (Table 1) are based on empirical relationships between body size and substrate particle sizes found in spawning redds (Kondolf and Wolman, 1993).

*Table 1. Particle size classification by size range and salmon use.*

| Particle Size Class   | Size Range (mm) | Salmon Usage                     |
|-----------------------|-----------------|----------------------------------|
| Small Spawning Gravel | ≥ 8 – 64        | All Salmonids                    |
| Large Spawning Gravel | ≥ 64 - 128      | Large-Bodied Salmonids (≥ 35 cm) |

Small-bodied salmonids are defined as species that are typically less than 35 cm long when mature, including resident rainbow, resident cutthroat, anadromous cutthroat, bull trout (dolly varden), brown trout, brook trout, and kokanee. These fish spawn in gravel that is generally between 8 mm and 64 mm in size. Large-bodied salmonids are defined as species that are typically greater than 35 cm when mature, including pink, chum, coho, sockeye, steelhead, and chinook salmon. These fish spawn in gravel that is generally between 8 mm and 128 mm in size.

**1.3 Cooperator Services**

The TFW Monitoring Program provides a comprehensive suite of services to support TFW cooperators collecting data consistent with program goals. Services include study design assistance, pre-season training through annual workshops and on-site visits, pre-season quality assurance reviews, data entry systems, summary reports of monitoring results, and database/data archiving services. These services are offered free of charge. TFW method manuals are available for the following surveys:

*TFW Manuals*

- ♦ Stream Segment Identification
- ♦ Reference Point Survey
- ♦ Habitat Unit Survey
- ♦ Large Woody Debris Survey
- ♦ Stream Temperature Survey
- ♦ Spawning Gravel Composition Survey
- ♦ Spawning Habitat Availability Survey
- ♦ Spawning Gravel Scour Survey
- ♦ Wadable Stream Discharge Meas. Method

To find out more about TFW Monitoring Program services and products, contact us or visit our link on the NWIFC homepage. The address is:

TFW Monitoring Program  
 Northwest Indian Fisheries Commission  
 6730 Martin Way East  
 Olympia, WA 98516

Ph: (360) 438-1180  
 Fax: (360) 753-8659

Internet site:  
[www.nwifc.wa.gov](http://www.nwifc.wa.gov)

## 2. Study Design

A well designed monitoring study identifies changes in channel characteristics over time due to land management or natural disturbances. Poorly designed studies detect changes that are the result of differences in crew method application or changes in sampling location. Effective monitoring study designs require rigorous planning, documentation, and consistency in methods, method application, and data analysis. This ensures that the monitoring data produced meets the objectives of the project and monitoring plan.

Developing a study design involves identifying monitoring segments, selecting a survey method, timing of surveys, reviewing survey modification options, and planning for pre-season crew training and quality assurance reviews.

### 2.1 Identifying Monitoring Segments

The SHA Survey uses the TFW stream segment as the fundamental unit of analysis for characterizing spawning habitat availability and other characteristics. A basic step in study design development is identifying a group of candidate segments from which to select suitable monitoring segments or sub-segments.

The TFW method identifies stream segments based on gradient, valley confinement, and flow. A USGS 7.5 minute topographic map (photocopy worksheet) with delineated segments is required for this part of the study design development. Many streams have already been segmented through past TFW monitoring projects, Watershed Analysis processes, and the Salmon and Steelhead Habitat Inventory and Assessment Project (SSHIAP). If the stream has not been pre-segmented, or pre-segmented boundaries are not suitable for your monitoring plan, partition the river system into stream segments or sub-segments using the TFW Monitoring Stream Segment Identification method (Pleus and Schuett-Hames, 1998a) before continuing. Segment data documented on Form 1 and USGS topographic maps are required for data tracking and to provide important information for identifying segment boundary locations and access points.

### 2.2 Survey Method Options

The SHA Survey has two options for estimating the amount of available salmonid spawning habitat on a stream segment scale. The first option is the transect survey that uses dominant substrate information collected along transects to estimate the total surface area of potential spawning habitat in the bankfull and wetted channel (optional). The second option is the patch survey that provides more detailed information on the surface area and distribution of individual spawning habitat patches in the wetted channel. Table 2 provides a summary of the information that can be produced by the transect and patch surveys.

The transect survey involves collecting dominant substrate information along transects established across the bankfull channel at regular intervals in the stream segment. This produces estimates of the total surface area dominated by various size classes of substrate in the bankfull channel. Bankfull channel area is also measured so the percentage of the channel dominated by various size classes can be calculated. Potential spawning habitat is estimated based on the amount of small and large spawning gravel in the bankfull channel. This is *potential* spawning habitat because fluctuations in discharge may prevent some spawning gravel in the bankfull channel from being available to fish during the spawning season. Potential spawning habitat estimates are independent of discharge, so they are useful for comparing segments or monitoring conditions throughout a watershed. Wetted channel width and substrate in the wetted channel can also be measured to get a rough estimate of actual spawning habitat at a particular discharge.

The patch survey provides an accurate measure of spawning habitat available at a particular discharge, but takes more time than the transect survey. It involves detailed surface area measurements of individual spawning habitat patches in the wetted channel. Spawning habitat patch data are used to calculate the surface area and distribution of individual spawning habitat patches and the area of actual spawning habitat available at the discharge when the survey was conducted. They can be used to develop estimates of production in specific

Table 2. Information produced using the SHA Transect and Patch Survey method options.

| Metrics  | Transect Survey | Patch Survey |
|--|-----------------|--------------|
| Total surface area of spawning habitat in wetted channel                               | X               | X*           |
| Total surface area of potential spawning habitat in bankfull channel                   | X               |              |
| Percent wetted channel dominated by spawning gravel                                    | X               | X*           |
| Percent bankfull channel dominated by spawning gravel                                  | X               |              |
| Percent bankfull channel dominated by various size classes other than spawning gravel  | X               |              |
| Surface area and distribution of individual spawning habitat patches in wetted channel |                 | X            |

\* Surface area measurements taken with the patch survey are more accurate than those taken with the transect survey.

stream segments. Total wetted area is measured so that percentage of the wetted channel dominated by spawning habitat can be calculated.

### 2.3 Timing of Surveys

If monitoring will be focused on one or more salmonid stocks, then it is useful to know the distribution of those stocks throughout the watershed, the type of spawning habitat they prefer, and the time of year they spawn. The transect survey should be conducted at flow levels typical of the spawning period for the stock of interest if wetted channel information is being collected. If the only information needed is the potential spawning habitat in the bankfull channel, the transect survey can be conducted at any time of year, although summer would be the easiest due to low flows.

The patch survey should be conducted at flow levels typical of the spawning period for the stock of interest. This is generally easiest to accomplish immediately prior to the spawning season, although surveys should not be completed when fish are actually spawning. It may be helpful to review historical gauging station records to determine the range of discharges that typically occur during the spawning season, and make sure the survey is completed when the discharge is within that range. Surveys completed at different times on the same stream segment must be conducted at the same discharge (+/- 10%) for results to be comparable.

### 2.4 Study Design Based on Project Objectives

When designing a SHA monitoring study, it is important to carefully identify the monitoring objectives. For the project to be successful, it must be designed to achieve these objectives. Common objectives for SHA monitoring studies on forest lands include assessing the distribution of spawning habitat throughout a watershed, estimating the spawning habitat available for specific salmonid stocks, and monitoring spawning habitat availability for Watershed Analysis.

*Objective 1: Assess the distribution of spawning habitat throughout a watershed to either compare segments that have specific characteristics or to identify segments with spawning gravel.*

Monitoring segments should be randomly selected from throughout a watershed or from a group of streams with specific characteristics. For example, a random sample of stream segments could be chosen from streams in three different gradient classes. The channel assessment from Watershed Analysis or the Stream Segment Identification Method can be useful for identifying segments to choose from.

For these purposes, the spawning habitat transect survey is recommended because potential spawning habitat information is easier to collect and more useful for comparison between segments.

*Objective 2: Estimate the spawning habitat available for specific salmonid stocks to make estimates of production or to evaluate limiting factors.*

Segments should be selected from principal production areas or from streams throughout the range of the salmonid stocks. To evaluate limiting factors, it may be desirable to focus on segments with suspected limited spawning gravel or segments susceptible to gravel scour. Results of spawning ground surveys or information from local experts may be useful for finding streams with these characteristics.

For this purpose, the spawning habitat patch survey is recommended because it provides the most accurate information on spawning habitat available to fish during the spawning season.

*Objective 3: Monitor spawning habitat availability for Watershed Analysis.*

Stream segments can be selected using the procedures described above, or the selection process can be tailored to meet specific Watershed Analysis objectives. For example, to evaluate channel response of changes in watershed inputs or to monitor the effectiveness of forest practice prescriptions, segments are selected based on their likely response to those factors. Watershed Analysis causal mechanism reports and knowledge of where prescriptions have been applied can be useful.

Either survey can be used for watershed analysis monitoring, depending on the issue that is being addressed. For a preliminary assessment of the watershed or to compare stream segments, the transect survey is used. The transect survey is also used if assessments must be performed at a time of year when stream flows are not representative of the spawning season. The patch survey is used if specific salmonid stocks or production areas have been identified for monitoring.

## **2.5 Survey Modification Options**

Data collected using the SHA Survey methods are supported by the TFW-MP database and are used to produce standard data analysis summary reports. Data collected using these methods can be compared with other data collected using the same methods from around the state. Modifying the SHA Survey to collect

data on additional parameters that meet individual cooperator needs is acceptable if it does not compromise the integrity of the core parameters. Survey modifications are defined as any change to the core criteria and methods as documented in the latest version of the TFW method manual. In other words, data collected using the modified method would not be comparable at some level with data collected using the methods and criteria as stated in the manual.

For example, a cooperator interested in collecting data on spawning gravel patches with 8 to 32 millimeter dominant substrate size criteria must also collect data on patches with 32 to 64 millimeter spawning gravel. When combined, this data meets the core TFW-MP minimum requirements. Supplemental information can also be collected on additional parameters, as long as the core information is collected. Examples include associated geomorphic or habitat units, factors causing patch formation, embeddedness, and proximity to holding habitat and cover. No guidance for measuring these optional parameters is provided in the manual. Analysis of modified data is the responsibility of the cooperator.

There are two levels at which modification documentation is important. The first is to qualify data collected on the field forms and the second is to qualify data entered into the TFW database. Documentation in the *Survey Notes* sections of Form 9.0 allows accurate interpretation of field data. It is feasible to have the field forms flagged as modified, but not the database where core data has been extracted by the cooperator before data entry. Documentation of modification in the database allows accurate interpretation of affected parameters and calculations on summary reports. However, in most situations modified data cannot be entered into the database due to validation checks.

The field forms provided in the manuals have been designed for consistent and accurate recording of SHA Survey data. The forms have been refined based on research and monitoring experience to reduce data errors caused by factors such as legibility, required parameter field calculations, and data transfer during database entry. The field forms can usually accommodate the collection of additional parameter data, thus limiting the necessity of cooperators to modify or create new forms. Contact the TFW Monitoring Program for assistance in modifying the methods to ensure data integrity and compatibility.

## **2.6 Pre-Season Crew Training and Quality Assurance Review**

Cooperators are strongly encouraged call the TFW Monitoring Program to make appointments for pre-season training and quality assurance (QA) reviews. This ensures that field crews are applying survey methods correctly from the start and that the highest quality data is being collected throughout the survey. Training should be repeated annually to learn new methods, techniques, or simply refresh skills. QA reviews should be repeated seasonally to maintain documentation and to refresh survey skills.

### 3. Pre-Survey Preparation

This section describes all necessary survey equipment and materials required for field crews to complete the field portion of the SHA Survey. These lists are not intended to cover all possible survey equipment and materials that could be of use.

#### 3.1 Survey Equipment

Acquire, check, and calibrate survey equipment well before the date the survey is scheduled to begin. The following list of survey equipment contains items necessary for crews to conduct the SHA Survey. The equipment includes:

##### *Survey Equipment*

##### *Channel Width Measurement*

- ♦ Hip chain (w/bio-degradable string)
- ♦ Measurement tape  
(30 - 50 m: accuracy  $\pm 0.10$  m)
- ♦ Measuring rod  
(5 - 7 m: accuracy  $\pm 0.01$  m)
- ♦ Measuring tape anchoring pins & spring clips
- ♦ Standard field and vehicle gear (Appendix C)

##### *Transect Survey*

- ♦ All channel width measurement equipment
- ♦ Calipers or plastic ruler  
( $\geq 150$  mm: accuracy  $\pm 1$  mm)

##### *Patch Survey*

- ♦ All channel width measurement equipment
- ♦ All channel width measurement equipment
- ♦ 25 wire stake flags and carrier  
(assorted 21" to 36")

The use of metric measurement equipment complies with standard scientific methods. Mixing measurement unit types (metric/English) within a survey is strongly discouraged due to potential for multiple conversion errors. If using English units, all measurements must be converted to metric units before entry into the TFW-MP database. The cost of purchasing metric equipment is often offset by savings in personnel time and effort

required to convert from English to metric units. It also results in the highest quality data due to avoidance of errors during conversion of large data sets.

Check all measurement equipment for damage before using. Calibrate all measurement equipment to a standard of known accuracy before and after the survey to ensure that the instruments provided accurate data during collection.

#### 3.2 Survey Materials

Survey materials are those items necessary for crews to locate and document the stream segment and access points, site conditions, and for recording field data. This list does not cover all possible materials. The basic materials include:

##### *Survey Materials*

- ♦ USGS 7.5 minute topographic map photocopy worksheet
- ♦ Road map
- ♦ Copy of Segment Identification Form 1.0 and Reference Point Survey Form 2.0
- ♦ Copy of SHA Forms 9.0, 9.1, 9.2, and 9.3 as needed (Appendix A)
- ♦ Copy of SHA Criteria and Code Field Sheet (Appendix C)

Start by gathering and organizing stream site access information and working on logistical factors. This includes: obtaining directions and maps; contacting landowners and securing permission to access property; acquiring necessary permits and passes; and determining if the access roads are gated and get gate keys or make necessary arrangements with landowner to open access. Next, begin the survey documentation by preparing and filling-out header and field data forms. Refer to Appendix B for examples of completed field forms.

### 3.2.1 SHA Survey HEADER INFORMATION Form 9.0

A new Form 9.0 is completed for each segment surveyed. Use the Form 9.0 copy master to make a copy on regular white paper (Figure 1). Most header information can be copied directly from the segment's completed Form 1. The Water Resource Inventory Area number (WRIA #), unlisted tributary number (Unlisted Trib), segment number (Segment #), Sub-Segment Code, and Begin Survey Date (Study Design Information" section) are key fields used to identify unique monitoring segments for the TFW-MP database. Refer to the Stream Segment Identification method manual for more information if needed (Pleus and Schuett-Hames, 1998a).

The form is titled "SHA SURVEY HEADER INFORMATION FORM 9.0". It includes fields for "WRIA #", "Segment #", "Date", and "Page of". The "Study Design Information" section includes "Begin Survey Date", "End Survey Date", "Survey Length", and "Survey Coverage" (with radio buttons for WHL, SIB, PRT, SUB, OTH). The "Sample Method Information" section includes "Crew", "Survey Coverage" (with radio buttons for Trained, Trained + Wet, Patch), and "Discharge Information" (with radio buttons for TFW, Mid-TFW, Non-TFW). The "Equipment" section is a table with columns: Equipment, Type, Size, Cost, Accuracy, Pre-Calibrated, Post-Calibrated. There are also sections for "Survey Notes" and "Error Checking" (with fields for Form #, Error Checked by, Date).

Figure 1. SHA Survey HEADER INFORMATION" Form 9.0.

#### Header Section

**Stream Name:** Record the WRIA-designated stream name. Use "Unnamed" where appropriate.

**WRIA #:** Record the six digit Water Resource Inventory Area (WRIA) number (00.0000).

**Unlisted Trib:** Only streams without assigned WRIA numbers require unlisted tributary numbers. For streams with WRIA numbers, fill this space with three zeros (000). For unlisted tributaries, record the previously identified three digit cooperater-designated unlisted tributary number (001 - 999) and mark the appropriate right or left bank (RB/LB) circle.

**Segment #:** Record the one to three digit segment number (1 - 999).

**Sub-Segment Code:** If the survey reach is a sub-segment, record the number or letter character sub-segment code (1 - 99 or a - zz). Record a "0" if not a sub-segment.

**Date:** Enter the date this form is being filled-out.

#### Survey Crew Section

Record the names and affiliations of the lead, recorder, and other field crew involved in data collection for the survey. Affiliations correspond to employers such as a tribe, government agency, industry, environmental group, consulting company, etc. Record the most recent year that the lead crew person received official TFW Monitoring Program on-site and/or annual workshop LWD training, and/or a QA Review. Note any other relevant training or field experience in the *Survey Notes* section.

#### Study Design Information

**Begin/End Survey Dates:** Record the dates based on Forms 9.1, 9.2, and 9.3 that SHA Survey field data collection began and ended for that segment. The *Begin Survey Date* is a key database field used to track and identify this specific survey.

**Survey Length:** Where the entire segment was surveyed, record the segment length as documented in total cumulative distance on Form 9.1, or from the *Study Design Information* section on the Reference Point Survey Form 2H. Where only portions of the segment were surveyed (see partial coverage below), record the total length of reach actually surveyed within the segment.

**Survey Coverage:** Fill-in the survey's coverage circle and percentage of the survey length that best applies to the survey. Mark *WHL* if the whole or entire segment or sub-segment was inventoried for sample collection (100%). Mark *PRT* if the survey was applied on a consecutive length of a partial segment/sub-segment. For example, where only the first 500 meters of a 2,000-meter-length segment will be inventoried for sample collection (25%). Mark *SUB* if the survey was applied using a random or systematic placement sub-sampling strategy. For example, where every other 100 meter interval reach will be inventoried for sample collection

(50%). Mark *PSB* if a combination of PRT and SUB was applied. Mark *OTH* if your study design differs from the above.

*Partial/Other Survey Location:* These locations are associated with survey length lower and upper boundaries - that is, the boundaries encompassing the section of stream actually surveyed. Record the WRIA river/stream mile locations to the nearest tenth of a mile (0.0 - 9999.9) and reference point numbers (0 - 9999).

#### *Sample Method Information*

*Core Survey Coverage:* Fill in the circle(s) corresponding to the method(s) applied on the segment during this survey. Options include transect, transect plus wetted channel information (+ *wet*), and patch methods.

*Transect Intervals:* Record the interval distance used between transects. The most common intervals are 25, 50, and 100 meters.

*Survey Criteria:* Fill in the circle corresponding to whether the criteria and procedures used during the survey were TFW, Modified TFW, or Non-TFW. For modified and non-TFW surveys, list the additions or changes in the *Survey Notes* section.

#### *Discharge Information*

Record all date and discharge measurements from Forms 7.0 and 7.1 that apply to this survey. If discharge was not taken, write "N/A" in the box.

#### *Equipment Section*

As equipment is selected for conducting the survey, document the equipment type, size, condition, measurement accuracy, and pre-survey calibration dates as indicated. Mark the appropriate circle corresponding to whether equipment is in metric or English units. Document the type of wading gear used (*wet/knee/hip/chest/dry/swim/etc.*). Document any other measurement equipment used during the survey.

Select wading gear to accommodate stream and survey conditions. On most streams, having one crew member with chest waders is important for access to, and taking measurements along the deeper parts of the channels. Having only knee or hip boots for a larger stream can result in under-estimation of unit surface areas and

residual pool depths. However, it is important to note that use of chest waders in fast flowing streams can be dangerous. Also consider future repeatability of each option. For example, wading wet or swimming may be acceptable to crews one year, but may not be an option the next time.

#### *Survey Notes Section*

Record driving and access directions sufficient for a person unfamiliar with the area to locate the temperature station area. This section is also used to provide brief notes related to unique survey conditions and problems encountered. Note any additional parameters and modifications made to the TFW-MP TEMP Survey procedure used to meet individual cooperator needs. Additional information can be included on the back of the form or on separate sheets of paper.

#### *Error Checking Documentation Section*

The section on documenting error checking procedures (lower right-hand corner of form) will be covered in the Post-Survey Documentation section.

#### 3.2.2 *SHA "CHANNEL WIDTH DATA" Form 9.1; SHA "TRANSECT DATA" Form 9.2; and SHA "PATCH DATA" Form 9.3*

Use copy master(s) as needed for the specified surveys to make one copy on regular white paper for additional copying purposes (Figure 2). Record the *Stream Name/ WRIA #/Unlisted Trib/Segment #/Sub-Segment Code* as documented on Form 9.0. Fill in the circle corresponding to whether measurement units will be recorded in meters or feet. Record the initials of the crew lead and other crew in the spaces provided in the upper right-hand corner. Leave the "Page \_\_ of \_\_" and "Date" spaces blank as they are recorded in the field during the survey.

Use these copies to make multiple field copies onto waterproof paper. This process eliminates the need to fill out all header information on each form. Copies can be made single-sided or duplex.



The figure shows three forms used for SHA Survey data collection:

- Form 9.1: CHANNEL WIDTH DATA** - A grid for recording channel width measurements across multiple transects. It includes columns for Tran #, CSM, Dist, BFW, Wetted Width, and Field Notes.
- Form 9.2: TRANSECT DATA** - A grid for recording detailed transect measurements. It includes columns for Tran #, Type, Width, and various measurements (e.g., Wetted, Dry, Substrate).
- Form 9.3: PATCH DATA** - A grid for recording patch characteristics. It includes columns for Patch #, Length, Width, and Field Notes.

Figure 2. SHA Survey CHANNEL WIDTH DATA" Form 9.1, TRANSECT DATA" Form 9.2, and PATCH DATA" Form 9.3.

### 3.2.3 SHA Criteria and Code Field Sheet

Use the copy master to make one copy on waterproof paper (Figure 3). Laminating this sheet will prolong its usefulness. This sheet provides all pertinent survey criteria and documentation codes including a complete key piece volume matrix for quick and easy reference in the field.

**SHA Survey Criteria & Code Field Sheet** (Appendix C)

| Segment Length | Transect Interval (m) | Particle Size Class           | Size Range (mm)            | Code # |
|----------------|-----------------------|-------------------------------|----------------------------|--------|
| < 100          | 10% of length         | Silt/Sand                     | < 8                        | 1      |
| ≥ 100 - 500    | 25                    | Small Spawning Gravel         | ≥ 8 to 64                  | 2      |
| ≥ 500 - 1500   | 50                    | Large Spawning Gravel         | ≥ 64 to 128                | 3      |
| ≥ 1500 - 2500  | 100                   | Boulders                      | ≥ 128                      | 4      |
| ≥ 2500         |                       | Bedrock                       | ≥ 1 m <sup>2</sup> Exposed | 5      |
|                |                       | Other (LWD, Clay, Peat, etc.) | ≥ 0.5 m                    | 6      |

| Patch Length | Minimum # Paces per Width Meas. | Minimum Patch Criteria                  |
|--------------|---------------------------------|---|
| < 2.5 to 5 m | 1 step                          | Dominant Substrate Size ≥ 8 to < 128 mm |
| ≥ 5 to 10 m  | 2 steps                         | Substrate Depth ≥ 23 cm                 |
| ≥ 10 to 20 m | 3 steps                         | Water Depth ≥ 10 cm                     |
| ≥ 20 m       | 4 steps                         | Water Velocity > Slack                  |
|              |                                 | Patch Size ≥ 1 m <sup>2</sup>           |

**Small (S) Spawning Gravel Size:** ≥ 8 to < 64 mm  
**Large (L) Spawning Gravel Size:** ≥ 64 to < 128 mm

**Side Channel Criteria**  
 Channel must be separated from Primary Low Flow Channel by an Island

**Island:**  
 1) length of the island above the bankfull channel is 2 times the estimated bankfull width; and  
 2) separated by two or more perpendicular planes that are greater than 2 meters in height.

**B-Axis Measurement**

**Longest Axis (A)**  
**Shortest Axis (B)**  
**Intermediate Axis (C)**

**Approximate B-Axis Size Classes (NOT FOR MEASUREMENT USE)**

|      |       |        |
|------|-------|--------|
| 8 mm | 64 mm | 128 mm |
|------|-------|--------|

**Language & Symbols**

- > Disregard wetted depth criteria and jump patch width to the wetted edge where the minimum water depth is within:
- \*\* 0.5 meters (Segment Mean BFW < 10 m); or
- \*\* 1.0 meters (Segment Mean BFW ≥ 10 m).
- > Split patch water: use same Patch # next nearest sequential Sub-Patch #.
- \*\* at Reference Points
- \*\* where they cross into a side channel
- \*\* where splitting can significantly improve surface area measurement accuracy
- > QA Note: Patch boundary ID is largest variability factor between crews. To reduce:
  - 1) Do only once flow
  - 2) Use confidence/default technique
  - 3) Mark boundary with weighted or wire flag

Figure 3. SHA Survey CRITERIA & CODE FIELD SHEET."

## 4. Stream Discharge Measurement

Information collected in the wetted channel is highly dependent on flow conditions. For this reason, whenever wetted channel information is collected on a stream segment, it is essential to collect discharge information. This information will help determine whether the discharge at the time of the survey is representative of flows during the spawning season, and whether surveys completed in different years can be compared. In the SHA Survey, a discharge measurement is always needed for the patch survey, but it is only needed for the transect survey if the optional wetted channel information is collected. If the intent is only to use the transect survey to estimate *potential* spawning habitat in the bankfull channel, then no discharge measurement is necessary.

Discharge measurements are taken using the TFW Monitoring Program Wadable Stream Discharge Measurement method (Pleus, 1999). Stream discharge measurements are recorded using WSDM Forms 7.0 and 7.1, and the results are then copied onto SHA Form 9.0. It is important that the rest of the survey be completed as soon after the discharge measurement as possible. If the discharge changes substantially over the course of the survey, then the data should be thrown out, and the segment is re-surveyed at a more stable discharge. Repeating the discharge measurement at the end of each survey could provide helpful information for making this decision.

## 5. SHA Survey Methods

This section provides procedures for conducting the SHA Survey using either the transect or patch method options. This section can be copied for crews to take out into the field for referencing specific procedures. Forms 9.1, 9.2, and 9.3 have been designed to record, organize, and track the information gathered using these methods.

The first step in conducting either the transect or patch survey is to establish transects at systematic intervals throughout the stream segment. Channel width information is then collected at each transect. If the transects survey is being done, substrate data is collected along the same measurement transects. If the patch survey is being done, patch data is collected within the wetted channel interval between two consecutive transects.

The section is divided into three parts including: 1) channel width measurement procedure; 2) SHA transect survey procedure; and 3) SHA patch survey procedure. The SHA Survey method will be explained as if a crew were conducting the survey for the first time on one stream segment within a watershed. This procedure can be applied on a watershed level by systematically following the same methods segment by segment.

### 5.1 Channel Width Measurement Procedure

The SHA channel width measurement procedure is conducted in coordination with both the transect and patch surveys. Channel width measurement data is recorded on Form 9.1. There are five basic steps to the channel width measurement procedure including: 1) establish transect points at systematic intervals; 2) establish the transect orientation line; 3) establish the transect and measure bankfull width; 4) measure wetted width (optional for transect survey); and 5) transect and patch survey options.

**Step 1:** *Establish transect points at systematic intervals.*

Table 3 shows the transect intervals recommended to capture channel variability for various stream segment lengths.

Table 3. Recommended transect intervals by stream segment length.

| Segment Length | Transect Interval (m) |
|----------------|-----------------------|
| < 100          | 10% of length         |
| ≥ 100 - 500    | 25                    |
| ≥ 500 - 2500   | 50                    |
| ≥ 2500         | 100                   |

The first transect placement is at the lower boundary of the stream segment or sub-segment. Place a weighted flag to identify the approximate boundary midpoint within the bankfull channel. Record the transect number in the *Tran #* column. Transect numbers are assigned sequentially in ascending order starting with number "1." Record transect location as measured distance from the downstream segment boundary along the center of the bankfull channel in the *Cum Dist* column. The cumulative distance for *Tran # 1* at the lower segment boundary is always "0". The cumulative distance for the last transect at the upper segment boundary is always the total distance measured between the lower and upper segment boundaries.

#### *Cumulative Distance Measurement Technique*

Cumulative distance is measured along the center line of the bankfull channel using the following technique. After completing Step 5, anchor the end of the hip chain line to an object at the transect interval's midpoint in the bankfull channel. Proceed up the center of the primary bankfull channel, staying midway between the banks and following the curvature of the channel (Figure 4). Anchor the hip chain line to objects along the channel to maintain proper position, especially when going around channel meanders. Pieces of branches pushed into the gravel are useful as anchor points. Follow the center line within the limits of personal safety and accessibility. The priority is to collect objective spawning habitat data by locating measurement transects at systematic cumulative distance intervals

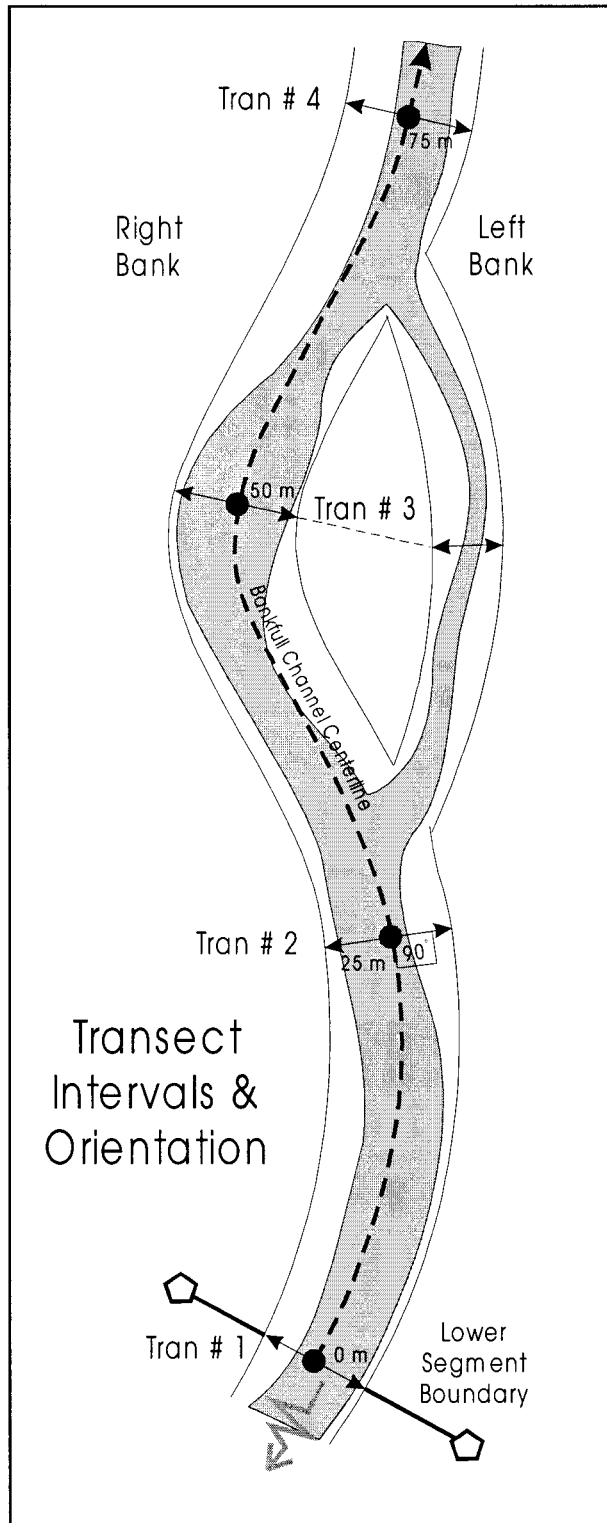

Figure 4. Transect intervals are measured along the center line of the bankfull channel.

taken from Table 3 (e.g., 0, 25, 50, 75, ...; 0, 50, 100, 150, ...; or 0, 100, 200, 300, ...). When the interval distance has been reached, place a weighted flag to identify its approximate boundary midpoint within the bankfull channel.

#### *Upper Segment Boundary Transect Placement Technique*

Transects are established until the distance between the last transect and the upper segment boundary is less than one-half, and no greater than one and one-half the interval distance. If the distance between the previous transect and the upstream boundary is less than one and a half intervals (i.e.,  $< 37.5$  m for a 25 m interval frequency), the last transect location is the upstream boundary. If the distance is more than one and a half intervals ( $\geq 37.5$  m), establish transects at both the 25 meter and upstream boundary locations. Always pick up used hip chain line by the end of your survey as part of keeping the stream clean and to prevent injury to wildlife.

#### **Step 2:** *Establish the transect orientation line.*

At each transect interval point, orient and mark the transect measurement line at a 90 degree angle to the center line of the bankfull channel. For multiple channel situations, transects are oriented at a 90 degree angle to the centerline of the adjacent and/or side channels.

#### *Transect Orientation Technique*

Using the transect interval point flag as a focal point, orient the transect line perpendicular to an imaginary line stretched up the center of the bankfull channel. Transect orientation can be determined using the following technique. Hold an extended stadia rod or other straight pole in front of your body so that the rod is parallel to squared shoulders. Start 5 to 10 meters below the boundary or transect interval marker and walk upstream along the center of the bankfull channel (Figure 5). When the stadia rod crosses the transect interval point flag, stop and use the rod as a sighting tool to identify and mark an orientation point on one bank. Repeat this process by starting above the transect marker and walking downstream. Mark a second orientation point on the same bank if different from the first. If the difference is large ( $> 1$  m), repeat the entire process. If the differences are small or can not be

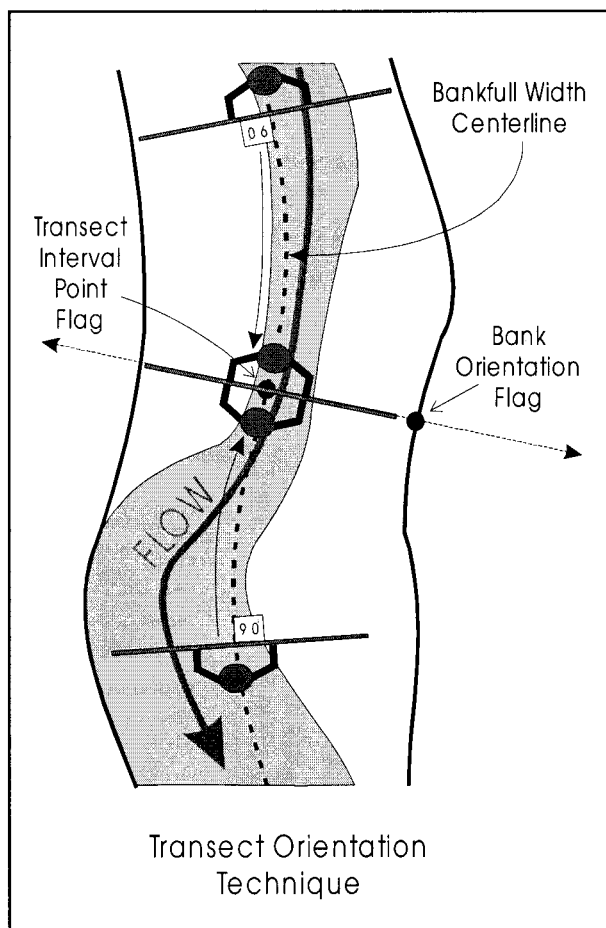

Figure 5. Transect orientation technique using an extended stadia rod or other straight pole.

resolved, use the midpoint between the two for the transect orientation point. A line drawn from the bank marker through the transect interval point marker forms the basis of a transect that is oriented at a 90 degree angle to the channel center line. Place flags or tie flagging on to vegetation where the line crosses the other bank.

**Step 3:** *Establish the transect and measure bankfull width.*

Identify the edges of the bankfull channel along the transect line, secure the measurement tape, and record the transect's bankfull width in the *BFW* column to the nearest 0.1 meter. Do not remove the bankfull width measuring tape until after Step 5.

### *Bankfull Channel Edge Identification Techniques*

Start on the bank with the best bankfull channel edge (BFCE) indicators. BFCE identification and bankfull width measurement use the same criteria and protocol as found in the Reference Point Survey (Pleus and Schuett-Hames, 1998b). Apply the confidence/default technique to identify the location of the BFCE using floodplain level, bank morphology and composition, and vegetation indicators. Begin by observing indicators from within the bankfull channel towards its suspected edge and mark the point on the bank with a wire flag or stick where you are no longer 100% confident in being within or below the BFCE elevation. Then, walk around to observe indicators from outside/above the bankfull channel towards the channel's suspected BFCE. Mark the point on the bank where you are no longer 100% confident in being on the floodplain or above the BFCE elevation. Reassess the indicators and confidence levels and make any adjustments. The default BFCE boundary is the point in elevation midway between the other two markings.

Follow the same procedure to mark the BFCE on the opposite bank. In situations where it is not possible to accurately identify the BFCE along the opposite bank, use a torpedo level to extend a level line horizontally across the channel from the bank with good indicators to determine the BFCE on the bank lacking indicators. This often occurs on the outside bank of a meander bend. Once secured, the distance between the BFCEs is the bankfull width.

### *Difficult Situations*

*LWD and Other Measurement Obstructions:* Measure or estimate bankfull widths as closely as possible as if the obstructions did not exist and record the estimated accurately in the *Field Notes* column (e.g., +/- 0.5 m, 1.0 m, 5.0 m etc.). Use the confidence/default technique for complex situations.

*Beaver Ponds and Undercut banks:* Where transect line crosses a beaver pond and the water level is above the edges of the bankfull channel, the bankfull and wetted channel widths are the same. Where a transect line crosses an undercut bank and the bankfull channel edge is obscured, use the confidence/default technique to identify a measuring point.

**Multiple Channel Transects:** Multiple channels include wetted or dry side channels connected to the primary low flow channel, but separated by gravel bars and islands that are higher than bankfull height. Where multiple channels are encountered along a transect line, the transect number stays the same, but each channel's bankfull widths are recorded on separate rows. Complete Steps 1-5 starting at the primary channel before doing the same at adjacent and side channel transects. When all portions of the channel have been measured, use the next blank row to record the calculated bankfull width total and circle it. Only the totals are entered into the database for that transect number.

**Large Obstructions:** In rare situations, large obstructions or crew safety may prevent even an objective estimation of bankfull width measurement at the interval point. The rule for adjusting the transect location is that no two transects can be placed closer than a half-interval distance. If the closest viable point downstream is less than half an interval from the previous one, go upstream of the obstruction to the first viable point. Resume the systematic interval placements from this point. Cumulative distances reflect the placement of the adjusted transects along the bankfull channel center line. If the obstruction exists at a segment boundary, transect adjustments must be made so that measurements are taken at the nearest point within the segment boundaries. Adjustments are NOT reflected in the cumulative distance readings, but are identified in the *Field Notes* column. If the nearest viable point for making an objective estimation is more than a half-interval distance from the segment boundary, a subjective estimation is allowed.

**Step 4.** *Measure wetted width (optional for transect survey).*

Identify and measure the widths of all wetted portions along the bankfull channel transect line (width under the bankfull width measuring tape) and record them to the nearest 0.1 meter in the *Wetted Width (Measurements)* column brackets. These measurements are not required to be at a 90 degree angle to the wetted channel center line. Calculate the total wetted width for the transect by adding together all individual wetted width measurements and record to the nearest 0.1 meter in the *Wetted Width (Total)* column.

*Identification Technique*

From the thalweg out, the wetted edge is the point where the substrate particles are no longer completely surrounded by water or the water is restricted to small, isolated pockets. Refer to the TFW Habitat Unit Survey (Pleus et al., 1999) for more detailed information on identifying wetted channel edge boundaries. If conducting the Transect Survey, use a stadia rod held plumb with the wetted edge to mark their locations along the tape with a clip or flagging.

*Difficult Situations*

**Measurement Obstructions:** Measure or estimate wetted widths as closely as possible as if the obstructions did not exist and record the estimated accurately in the *Field Notes* column (e.g., +/- 0.5 m, 1.0 m, 5.0 m etc.). Use the confidence/default technique for complex situations.

**Multiple Channel Transects:** Where multiple channels are encountered along a transect line, the transect number stays the same, but each channel's wetted widths are recorded on separate rows. Complete Steps 1-5 starting at the primary channel before doing the same at adjacent and side channel transects. When all portions of the channel have been measured, use the next blank row to record the calculated wetted width total and circle it. Only the totals are entered into the database for that transect number.

**Step 5.** *Transect and patch survey options.*

Depending on whether the transect and/or patch surveys are being conducted, different options are presented.

**Transect Survey:** Do not remove the bankfull width measuring tape and skip to the "SHA Transect Survey Procedure" section. When the transect survey has been completed on that transect, return to this section and repeat Steps 1-5. Repeat this process until the end of the segment.

**Patch Survey:** Mark the location of the transect line across all wetted channels (including multiple channel situations) with flagging and remove the bankfull width tape. If this is the lower segment boundary transect, repeat Steps 1-5 to establish and collect channel width

data at the next transect interval. If this is the next sequential interval transect, skip to the SHA Patch Survey Procedure section and conduct the patch survey between the last and present transect lines. When the patch survey has been completed, return to this section and repeat Steps 1-5 to establish and collect channel width data at the next transect interval. Repeat this process until the end of the segment.

## 5.2 SHA Transect Survey Procedure

The SHA transect procedure requires collecting information on dominant substrate within the bankfull channel and along the transects established in the channel width measurement procedure. Transect Survey field data is recorded on Form 9.2. If desired, data on substrate located within the wetted portion of the channel can be recorded separately from that outside the wetted portion of the channel. If the wetted portion is separated out, this requires taking a discharge measurement (see Stream Discharge Measurement section) and collecting wetted channel width information on Form 9.1 as described in the Channel Width Measurement Procedure section above.

There are two basic steps to the transect survey procedure including: 1) identify and mark areas dominated by individual particle size classes; 2) identify and mark size class boundaries; and 3) record size class width data. After completing Steps 1-3, return to the Channel Width Measurement Procedure section to establish the next transect.

Table 4. Transect survey particle size class criteria and codes based on the Wentworth scale.

| Particle Size Class           | Size Range (mm)              | Size Class Code |
|-------------------------------|------------------------------|-----------------|
| Silt/Sand                     | < 8                          | 1               |
| Small Spawning Gravel         | ≥ 8 - 64                     | 2               |
| Large Spawning Gravel         | ≥ 64 - 128                   | 3               |
| Boulders                      | ≥ 128                        | 4               |
| Bedrock                       | ≥ 1 m <sup>2</sup> (exposed) | 5               |
| Other (LWD, Clay, Peat, etc.) | ≥ 0.5 m                      | 6               |

### Step 1: Identify and mark areas dominated by individual particle size classes.

This step is divided into three tasks. The first task is to identify dominant size class areas along the transect. The second task is to identify the boundary between each size class area. The third task is to record the size class code and width of each size class along the transect.

#### Dominant size class identification technique

Once a transect has been established, inspect the area along the tape and identify areas of dominant substrate that intersect the transect directly below the bankfull width tape. When determining the dominant substrate particle size class, it is important to focus on the surface area occupied by each particle size class - not the number of individual particles. Dominance is where more than half of the surface area is made up of a single size class. The greater area taken up by larger particles means fewer of them are required to be considered dominant. Pick up representative dominant particles and measure them to determine size class. Mark the approximate center of each size class along the transect that meets the minimum criteria. Start with the easiest areas to identify and tie two pieces of flagging (or color-coded clothespins) on the tape to mark those points (Figure 6).

Size class codes of 1 to 6 are assigned to areas of substrate equal to or greater than one square meter (1.0 m<sup>2</sup>) that is dominated by a single size class (Table 4). Size classes 2 and 3 (shaded rows) are most often used by salmonids for spawning. Minimum surface area criteria can be interpreted as either 0.5

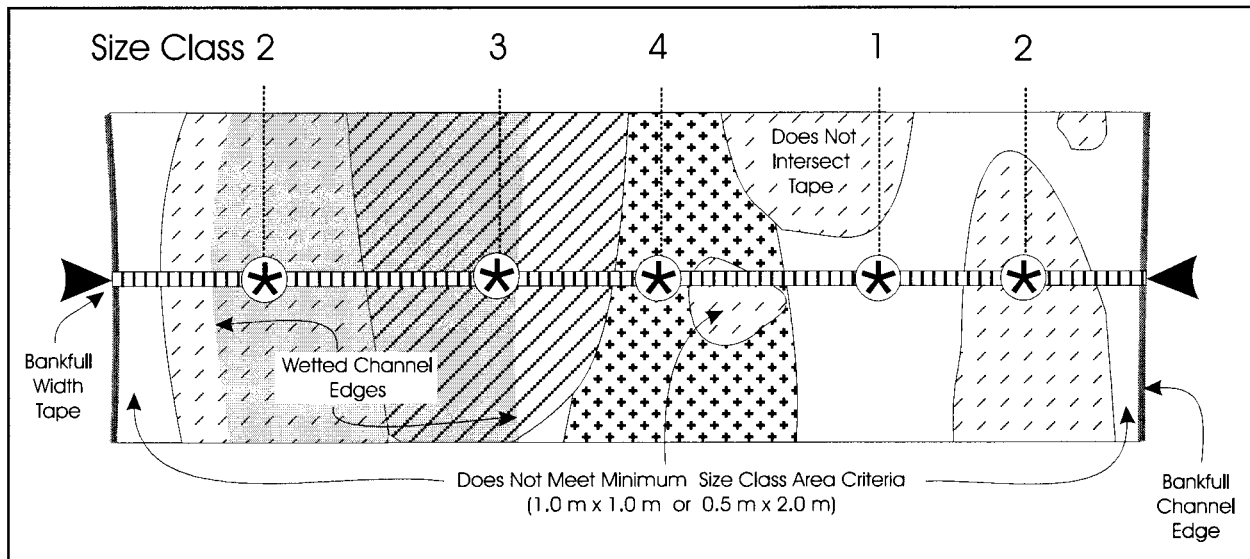

Figure 6. Example of identifying and marking areas along the transect dominated by individual particle size classes.

meter wide and 2.0 meters in length, or 1.0 meter wide and 1.0 meter long. Dominant areas that are less than 0.5 meters wide where they intersect the tape do not qualify and are not marked as part of the identification process at this point.

Size class codes and their particle size classes include: 1) silt/sand; 2) small spawning gravel; 3) large spawning gravel; 4) boulders; 5) bedrock; and 6) other factors. Particle size is determined by measuring across its b-axis using calipers or a ruler (Figure 7). Of the three axes that define the dimensions of a particle, the b-axis is intermediate between longest and shortest axes. After some practice, it is often possible to determine the size class of a particle without using a measuring device unless it is near a size class boundary. Estimates require checking periodically to ensure accuracy.

**Step 2.** *Identify and mark size class boundaries.*

The boundaries between size classes are often transitional areas, not clearly defined lines. The transitional areas can be defined using the confidence/default technique. Return to the easiest size class area marker first and move one flag at a time outwards to the point where 100 % confidence is lost that the flag is still within that size class area (Figure 8). Go to the marker at the adjacent size class area and repeat the process with that flag towards the first area. The space between the flags is the transitional area between size classes. Flags that

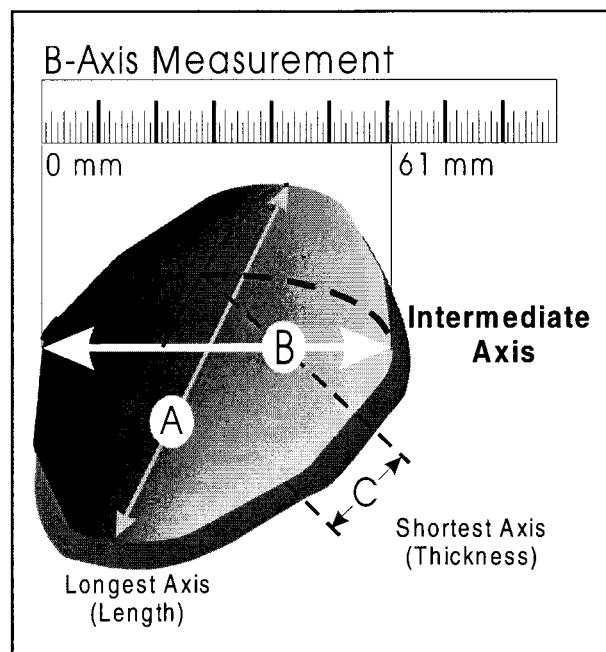

Figure 7. Particle size is determined by measuring across its b-axis using a caliper or ruler.

define a transitional area of 0.5 meters or greater must be assessed to see if they constitute a separate size class category. The default size class boundary is the point halfway between the two flags. Move the flags together at that point.



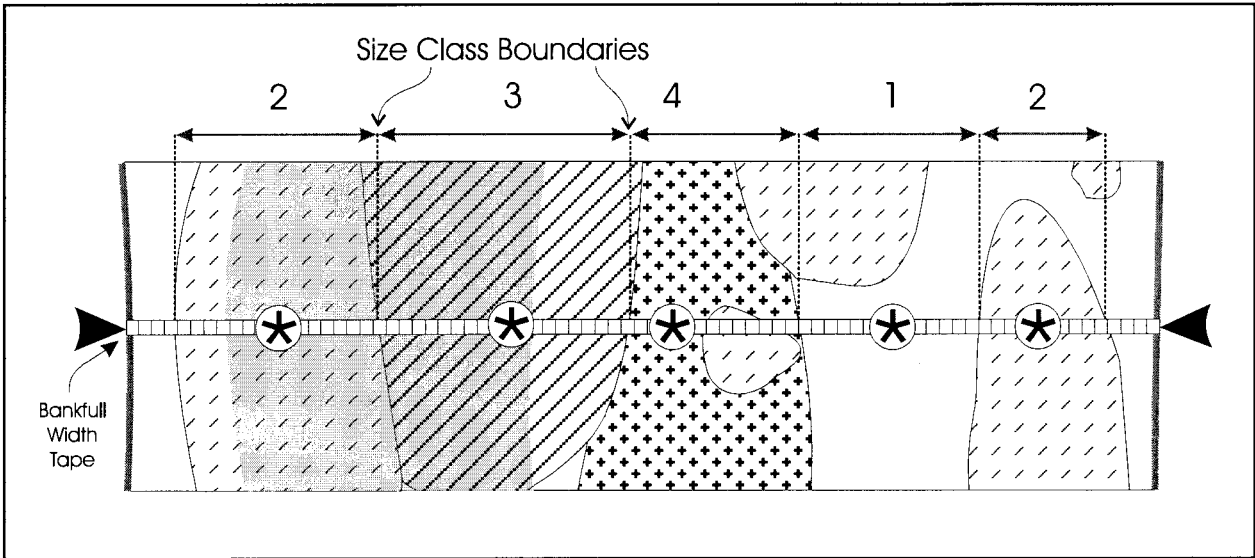

Figure 8. Identify and mark size class boundaries using criteria and confidence/default technique.

*Lumping rules for non-qualifying size class area boundaries*

After patch boundaries have been identified, there are often areas left over that do not meet minimum size class surface area criteria. The most common places are along the edges of the channel (Figure 9). In these situations, the non-qualifying area must be lumped, or added to an adjacent qualifying size class area using the following rules:

**Rule 1:** Channel edge areas are lumped into the adjacent qualifying size class area.

**Rule 2:** Within channel areas of spawning gravel (size (size class codes 2 and 3) are lumped with adjacent qualifying spawning gravel size class areas;

**Rule 3:** Within channel areas of non-spawning gravel (size class codes 1, 4, 5, and 6) are lumped with adjacent qualifying non-spawning gravel size class areas having the closest numerical value; and

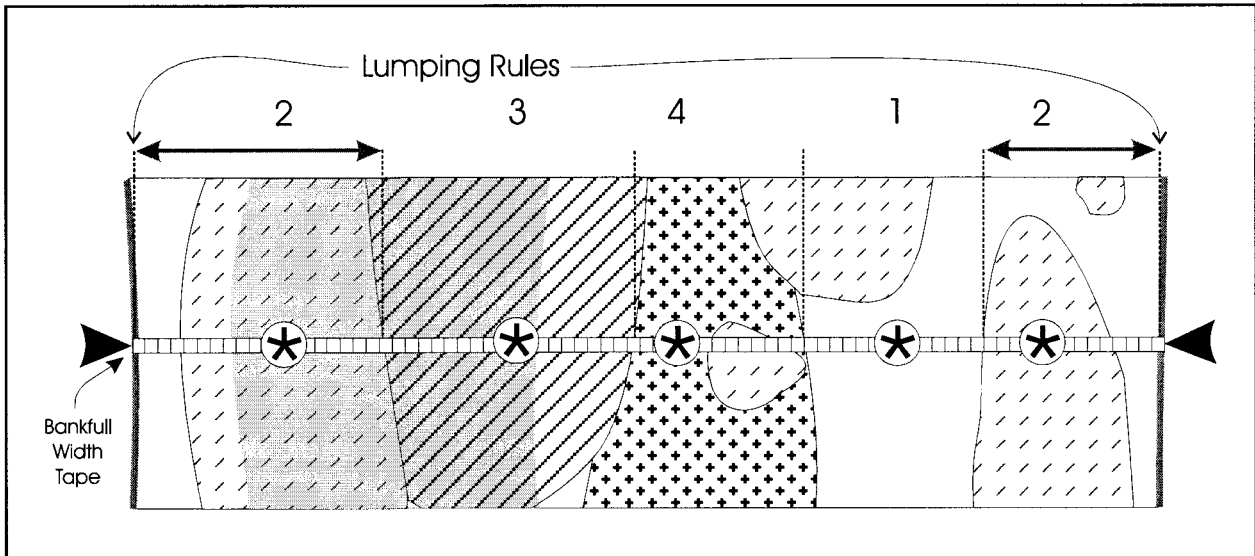

Figure 9. Apply lumping rules in areas that do not meet minimum size class surface area criteria.

**Rule 4:** Within channel areas bounded on both sides by either qualifying spawning or non-spawning gravel size classes are lumped with the adjacent qualifying size class having the next lowest or closest numerical value.

**Rule 1 example:** A sandy area (class 1) along the edge of the channel that is less than 0.5 meters wide along the transect must be lumped with the adjacent qualifying area regardless of size class.

**Rule 2 example:** A non-qualifying area of small spawning gravel (class 2) bounded on one side by a qualifying area large spawning gravel (class 3) and on the other by a qualifying area of boulders (class 4) must be lumped with the large spawning gravel area.

**Rule 3 example:** A non-qualifying area of large woody debris (class 6) bounded on one side by a qualifying area of large spawning gravel (class 3) and on the other by a qualifying area of sand (class 1) must be lumped with the sand area.

**Rule 4 example:** A non-qualifying area of small spawning gravel (class 2) bounded on one side by a qualifying area of sand (class 1) and on the other by a qualifying area of bedrock (class 5) must be lumped with the sand area. A non-qualifying area of sand (class 1) bounded on one side by a qualifying area of small spawning gravel (class 2) and on the other by a qualifying area of large spawning gravel (class 3) must be

lumped with the small spawning gravel area.

*Difficult Situations*

**Measurement Obstructions:** Measure or estimate bankfull widths as closely as possible as if the obstructions did not exist and record the estimated accurately in the *Field Notes* column (e.g., +/- 0.2 m, 0.5 m, 1.0 m, etc.). Use the confidence/default technique for complex situations.

**Step 3. Record size class width data.**

Record the width measurements to the nearest 0.1 meter and size class code for each qualifying size class area along the transect tape (Figure 10). Width measurements are recorded in the *Width* column and particle size class codes are recorded in the *Size Class (1-6)* column. Optional wetted channel information is recorded in the *Dry Wet (D-W)* column. Size classes that are intersected by wetted channel edges are divided into dry (*D*) and wet (*W*) widths (minimum 0.1 meter width).

*Tape 1/Tape 2 technique (optional)*

The Tape 1/Tape 2 technique provides an efficient and accurate way for documenting and calculating size class widths across the transect tape. Working from the zero end of the tape, sequentially record the beginning and ending distances of each size class to the nearest 0.1

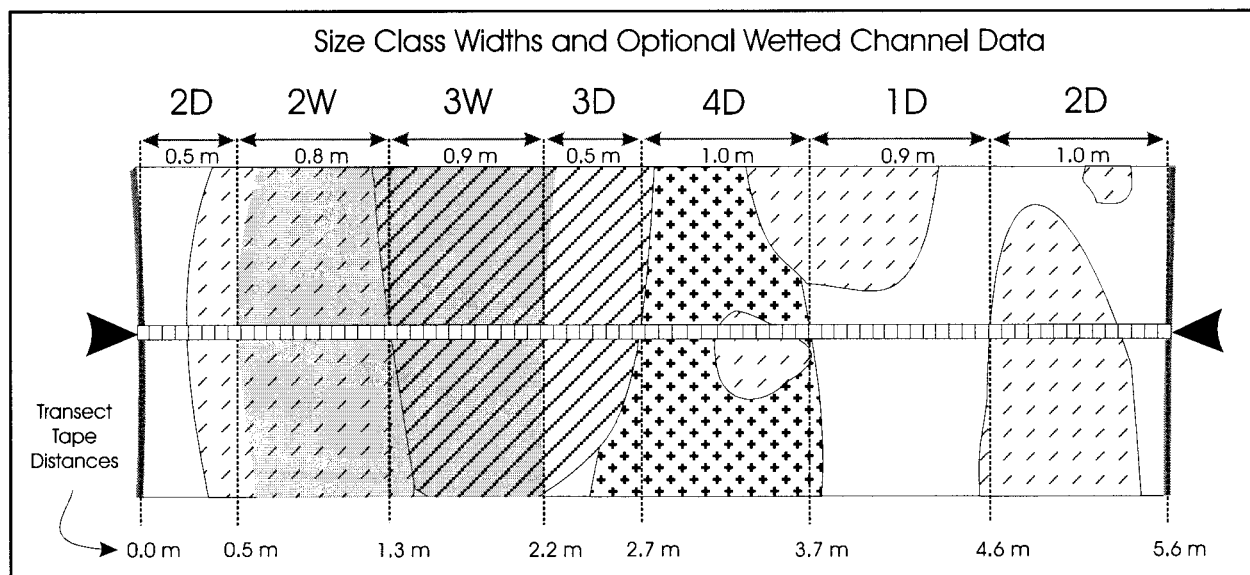

Figure 10. Procedure for measuring size class widths and identifying optional wetted channel boundaries.

meter along the transect tape (*Tape 1* and *Tape 2* (*Optional*) columns) identified in Step 1 or 2. *Tape 1* distances always identify the boundary closest to the tape's zero end. *Tape 2* distances are repeated in the next row's *Tape 1* column. This reflects that the ending point of the last size class boundary is the beginning point of the next. Size class width is calculated by subtracting each row's *Tape 1* reading from its *Tape 2* reading.

#### *Difficult Situations*

*Wide or complex transects:* In situations where the number of qualifying size class areas is greater than one transect box can record, continue recording size class width measurements in the next box using the same transect number.

### 5.3 SHA Patch Survey

The SHA Patch Survey is conducted by beginning at the downstream boundary of the segment and collecting information on individual spawning habitat patches in the interval between the last and present transect. Information from the SHA Patch Survey is recorded on Form 9.3. Data is only collected on wetted channel areas meeting the spawning habitat criteria. Working upstream prevents turbidity caused by walking in the stream channel from reducing visibility. This survey requires a discharge measurement prior to collecting data and the collection of wetted channel information during the channel width measurement procedure described above. Due to stream flow variability, it is important that discharge, channel width measurements, and patch data be collected as close in time as possible.

There are three basic steps to the patch survey procedure including: 1) patch identification; 2) patch and sub-patch boundary identification; and 3) patch surface area measurement. After completing Steps 1-3, return to the Channel Width Measurement Procedure section to establish the next transect.

#### **Step 1:** *Patch Identification.*

Identify spawning habitat patches and record the patch number in the *Patch #* column and either an *S* for small ( $\geq 8$ -64 mm) or an *L* for large ( $\geq 64$ -128 mm) dominant spawning gravel size class code in the *DOM SG* (*S-L*) column for each patch. Patch numbers are recorded

sequentially in ascending order starting with number "1." A patch is defined as one connected (contiguous) spawning habitat area in the wetted channel that meets the minimum criteria and is comprised of either small or large dominant spawning gravel.

#### *Patch Identification Criteria*

To identify a spawning habitat patch, there are five parameters to evaluate: 1) dominant substrate size; 2) substrate depth; 3) water depth; 4) water velocity; and 5) patch size. Each of these parameters must meet the minimum criteria in Table 5 for a patch to qualify. Think of the first four parameters as shapes on separate pieces of clear plastic outlining the area that meets each minimum criteria. The patch would be the area covered by the intersection of all four parameter shapes (Figure 11). If the area covered by the patch meets the minimum size criteria (1 m<sup>2</sup>), then it is included as a spawning habitat patch in this survey.

*Table 5. Minimum criteria for spawning habitat patch parameters.*

| Patch Parameter         | Minimum Criteria        |
|-------------------------|-------------------------|
| Dominant Substrate Size | $\geq 8 - 128$ mm       |
| Substrate Depth         | $\geq 23$ cm            |
| Water Depth             | $\geq 10$ cm            |
| Water Velocity          | > Slack                 |
| Patch Size              | $\geq 1$ m <sup>2</sup> |

The minimum criteria for identifying a spawning habitat patch was selected as recommended by Schuett-Hames and Pleus (1996). These minimum criteria are broad due to the extensive variation in reported values both within stocks and between stocks and species (Burner, 1951; Smith, 1973; Bjornn and Reiser, 1991; and Kondolf and Wolman, 1993).

#### *Patch Identification Techniques*

Dominant substrate size and substrate depth are the first parameters to consider when identifying spawning

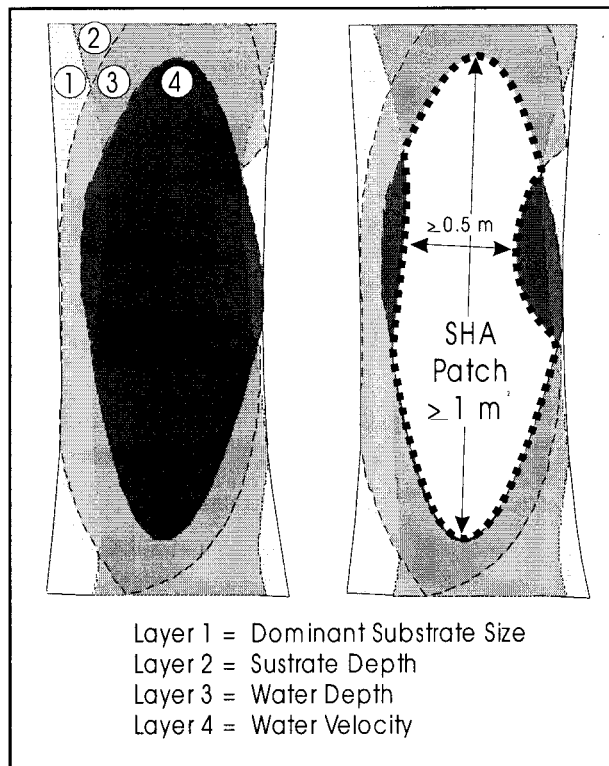

Figure 11. Example of different parameters viewed as layers and designation of a SHA patch where all five parameters intersect.

habitat patches. To qualify as spawning habitat, more than half of the surface area of a patch is made up of either small spawning gravel ( $\geq 8 - 64$  mm) or large spawning gravel ( $\geq 64 - 128$  mm). Substrate depth is evaluated with a quick visual assessment. It is assumed this criteria is met unless there is visible evidence to the contrary, such as where there are indicators that suggest an underlying outcrop of bedrock, a layer of impermeable clay, or where large boulders limit the depth of spawning gravel.

Water depth and velocity are relatively simple to evaluate. A 10 cm (0.1 meter) mark on wading boots or a stadia rod can be used to quickly determine whether the minimum criteria for water depth is met. To simplify area measurements, patch boundaries can be extended to the wetted channel edge in situations where the minimum water depth is met within 0.5 meters from the edge for stream segments that average  $< 10$  m bankfull width or within 1.0 meters from the edge for stream segments that average  $\geq 10$  m bankfull width. The water velocity criteria simply requires that the water covering the patch be flowing. Floating a leaf or small

twig on the surface can help detect motion. Surface movement from wind is not sufficient to meet the criteria. If in doubt, assume the water is *not* flowing and move on.

After a patch of spawning habitat has been delineated using all four criteria, it is then evaluated with the minimum size criteria ( $1 \text{ m}^2$ ). Minimum surface area criteria can be interpreted as either 0.5 meter wide and 2.0 meters in length, or 1.0 meter wide and 1.0 meter long. Often, only one parameter may prevent a patch from qualifying. For example, a patch could be quickly rejected because the area covered by spawning gravel was too small or because water covering it was not flowing.

### Step 2: Patch and sub-patch boundary identification.

Identify and mark patch and/or sub-patch boundaries and record its sub-patch number (*SUB Patch #*), downstream transect number association (*DWN Tran #*), and whether it is located in a side channel (*SIDE Chan (Y-N)*).

The boundary of one contiguous patch is where any one of the parameters fails to meet the minimum criteria. For example, boundaries are located where the dominant substrate changes to a different size class, the depth is less than 10 cm, or where the water no longer moves. Within a contiguous patch, sub-patch boundaries are possible for a variety of purposes. Wire stake flags are useful for marking patch and sub-patch boundaries.

### Sub-Patches

The sub-patch system allows large and complex patches to be broken into sub-patches at reference point and side channel boundaries, for accurate surface measurement purposes, and for identifying and characterizing cooperatively defined parameters. Divided contiguous patches use the same patch number, but are assigned unique sub-patch numbers which are recorded sequentially in ascending order starting with number "1" (e.g., 1-1, 1-2, 2-1, 2-2, 2-3, 3-1, 3-2, etc.).

*Downstream transect and side channel association*

Record the number of the nearest downstream transect associated with the patch location along the channel. Patches split by transect line boundaries are given the same patch number, but different sub-patch numbers. Record a "Y" (yes) or "N" (no) to identify whether a patch or sub-patch is located in a side-channel. Patches split by side channel boundaries are given the same patch number, but different sub-patch numbers.

*Patch boundary identification techniques*

Start by working out from the center of the patch until any one of the parameters fails to meet the minimum criteria. After placing a marker at this point, continue to follow the boundary and place more markers until the shape of the overall patch has been outlined. If the boundary is lost, return to where all criteria are easily met, and work back out toward the boundary.

Patch boundaries end at any linear object that completely separates the spawning gravel. For example, an embedded log cutting through a patch of spawning habitat effectively acts as a boundary and creates two patches. Each patch must meet minimum criteria individually to be included in the survey. However, objects that only project partly into, or span the substrate at any point, are included in the measurable patch area. Extend patch boundaries only where criteria can be visually confirmed. Do not guess whether a patch extends into deep water or under cut banks or log jams. Do not measure what is not visible, but be sure to use the *Field Notes* column to describe factors affecting the accuracy of measurement data.

In situations where patch boundaries are not clearly defined, use the confidence/default technique. From a known area of patch, move outwards to the point where 100 % confidence is lost that you are still within the patch. From the known outside area, move towards the patch area until 100 % confidence is lost that you are still outside the patch. The space between the flags is the transitional area between two patches or between a patch and non-patch area. The default patch boundary is the point halfway between the two flags. Place a flag at that point and repeat the technique as needed to define the entire patch boundary.

**Step 3:** *Patch surface area measurement.*

Patch length (*Length (Total)*) and width (*Width (Average)*) measurements are recorded for each sub-patch. These parameters will be used as the basis of surface area calculations in the database.

*Surface area measurement techniques*

Measuring spawning habitat patches requires taking single or cumulative length (*PATCH Length Measurements*) and several width measurements (*PATCH Width Measurements*). The most common length is placed so the area of the shape is entirely encompassed within 90 degrees of the endpoints (Figure 12). Width measurements are taken perpendicular to the baseline at systematic intervals. A pacing technique is used to identify systematic width measurement intervals. The number of paces per width measurement varies with the size of the patch (Table 6).

*Table 6. Guideline for minimum number of paces per width measurement for various patch lengths.*

| Patch Length (m) | Minimum # Paces per Width Measurement |
|------------------|---------------------------------------|
| < 2.5 – 5        | 1                                     |
| ≥ 5 – 10         | 2                                     |
| ≥ 10 – 20        | 3                                     |
| ≥ 20             | 4+                                    |

Spawning habitat patches are often complex shapes that are difficult to measure. The key is to position the baseline in a location that provides the easiest perpendicular width measurements. In situations where the patch is very long and goes around a bend or gravel bar, the baseline follows the general curvature of the patch. It may also be useful to break the patch into several smaller units that can be measured separately and added together later (with the help of the database) to estimate the total patch area. Similar to habitat units, patch surface area is divided at reference point boundaries.

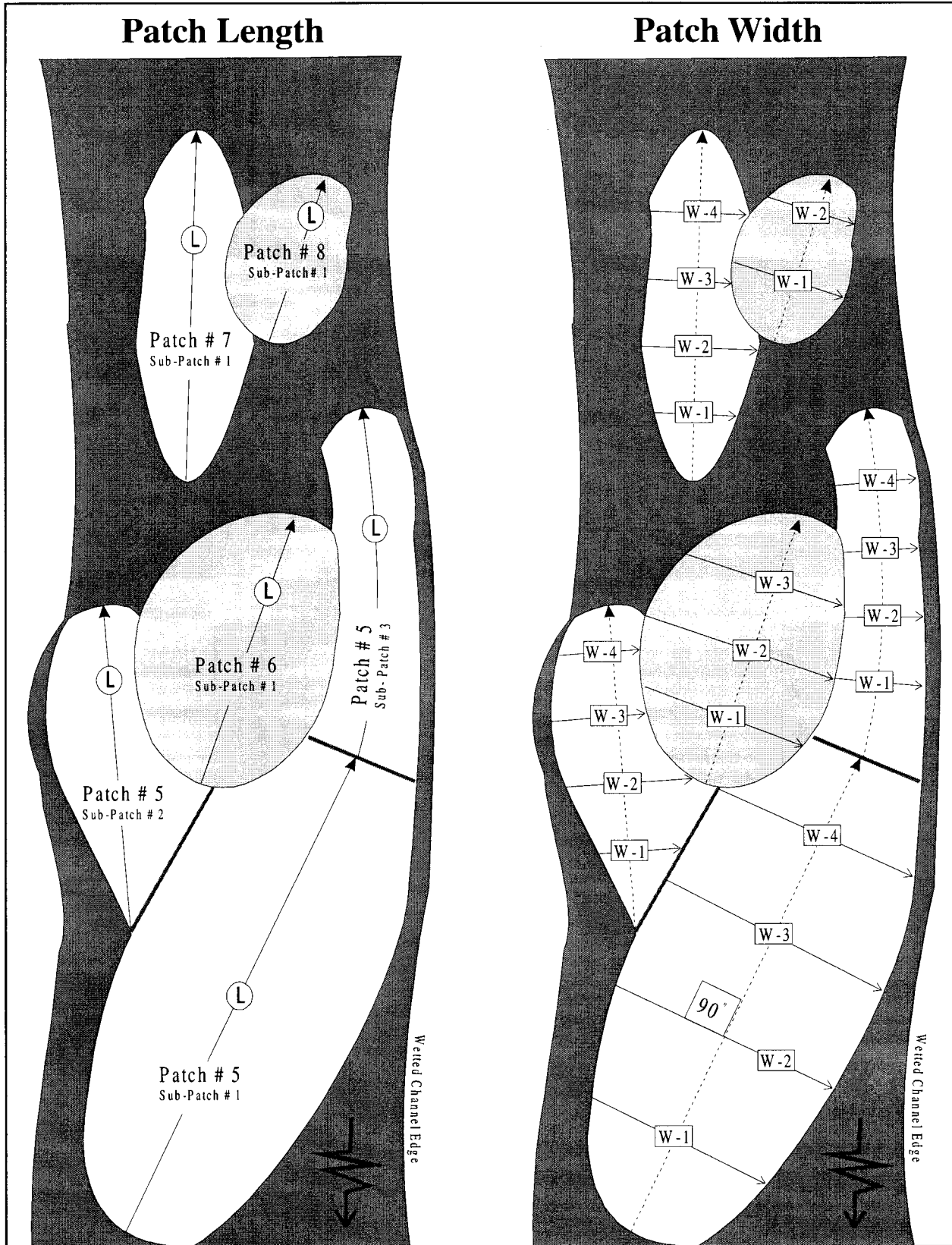

Figure 12. Patch length and average width measurement techniques.

Baseline and width measurements are most accurate when all spawning habitat patch boundaries are easily accessible. Natural obstacles, such as log jams and dense vegetation, combined with field equipment limitations and safety concerns, may prevent access to some visible patch boundaries. In these situations, measurements are taken or estimated as accurately as possible, and specific difficulties should be recorded as field notes to indicate reduced confidence in the measurement. These measurement limitations are part of the variability of any field survey.

## 6. Post-Survey Documentation

After completion of the field portion of the SHA Survey, field forms need to be organized, supplemental information and calculations completed, and all forms and information error checked before the data are ready to be entered into the database. This includes discharge survey forms and information. The objective of these tasks is to organize the data to ensure that this survey can be repeated the same way in the future by different crews.

### 6.1 Finalizing Survey Forms

Organize the forms and check for missing sheets. Systematically check each SHA Survey form for completeness. All blanks and boxes should contain information or a "I" to designate that no information is available or needed. The following list provides guidance on some common tasks.

*All Forms:* Complete Page \_\_\_ of \_\_\_ numbering related to form type. Count the number of total pages separately for Forms 9.0, 9.1, 9.2, and 9.3. The page numbers are filled in as used during the survey (e.g., Page 1 of \_\_, Page 2 of \_\_, Page 3 of \_\_, etc.). Forms that have been copied on both side of one sheet of paper will count as two separate pages. The total number of pages for that form type are filled in at the end of the survey (e.g., Page 1 of 6, Page 2 of 6, Page 3 of 6, etc.). Organize the field forms by type and then by page number for easy reference. It is common to have different totals for each type.

*Form 9.1:* Calculate cumulative distances that were not completed in the field. Calculate multiple channel total bankfull and wetted widths for error checking purposes.

*Form 9.2:* Calculate widths based on Tape 1 and 2 distances not completed in the field.

*Form 9.3:* Calculate patch total lengths and average widths that were not completed in the field.

### 6.2 Error Checking

Error checking of field forms is a very important task and sufficient time should be taken for its completion. It is best done during or immediately after data collection because it becomes more difficult to reconcile discrepancies and track down correct information as time passes. Contact the TFW-MP for assistance in determining how to handle missing data fields.

Review all field forms and material compiled during the SHA Survey. Have a second person look them over for completeness, legibility and errors. Every page of every form requires error checking for legibility, complete and consistent header information, obvious measurement and transcription errors, and calculation errors. Work systematically through each section and when completed, put your initials and date in the *Error Checked by* box at the bottom of each page. If the person error checking the data is not a crew member, their full name and task should be recorded in the *Survey Notes* section of Form 9.0. When all field forms relating to a temperature station have been error checked, record the initials of the responsible crew and date completed.



## 7. Data Management

The TFW Monitoring Program offers data management services to help cooperators quickly analyze data collected with the program methods and to produce standard monitoring reports. The heart of the service is a database system housed at the Northwest Indian Fisheries Commission. This database calculates parameters, produces reports and archives electronic versions of the data. The database is also an important archive of monitoring data that can be used for developing study designs and identifying control or reference sites. This section describes the process for data preparation, data processing and archiving, and data analysis.

### 7.1 Data Preparation

Before data entry can occur for the SHA Survey, some preparation must be done. The following materials are needed:

- ◆ completed and error-checked Forms 9.0, 9.1, 9.2, and 9.3 as needed for each segment,
- ◆ a data entry system;
- ◆ a set of data entry system instructions and an "Ambsys" data dictionary; and
- ◆ a copy of completed Stream Segment Identification Form 1.0

Before the data entry process can begin, an entry system must be selected. Choose a data entry system from the list below and request a free copy and user's manual from the TFW Monitoring Program. The database has three entry system options for survey data. These are:

- ◆ Microsoft Excel 4.0 pre-formatted spreadsheets;
- ◆ Lotus 1-2-3 (vers. 3) pre-formatted spreadsheets; and
- ◆ Microsoft Access 7.0 pre-formatted entry forms

Refer to Appendix D for an example of the Excel pre-formatted spreadsheet. Select a spreadsheet format if your data requires conversion from English to metric units. Replace all English unit measurements with metric equivalents. Read the instructions for the data entry system and the Ambsys data dictionary, noting the field

types and data constraints (what type of data can be entered into each field).

### 7.2 Data Processing, Products and Archiving

Open the section of the entry system pertaining to the SHA Survey on your computer. You must complete the header, width, transect and/or patch detail forms. Following the entry system instructions, enter the data from Forms 9.0, 9.1, 9.2, and 9.3 as directed. After the data has been entered and the session saved, error check the data entry. The most efficient process for this time-consuming activity is to have one person read the data off the screen and another check it with the original field form. Save the file a final time once the accuracy of the entered data is verified. When completed, record the initials of the responsible crew and date on Form 9.0.

Data can be sent to the TFW Monitoring Program using several different methods. Copies of all survey field forms and other documentation are required for archiving and can be hand delivered, mailed, or faxed to the program. An original or copy of a USGS topographic map is also required and can be hand delivered, mailed, or faxed. Maps must have upstream and downstream segment boundaries marked along the stream. If a photocopy of the map is used, make sure the township, range, section, contour intervals, map name, and publishing date are identified. The electronic versions of the data can be sent via e-mail, CD, or on a floppy disk. After the program receives the electronic files, the data is imported into the database by a TFW-MP staff person.

Safe and efficient archiving is also provided through Data Management Services. The data generated by individual cooperators is archived electronically in the database system. Hard copies of the field forms, topographic maps and supplemental information are archived at the TFW-MP facility to meet quality assurance needs and to reduce the chance of loss due to personnel changes or destruction. Access to cooperator data can be limited by request. Call for information on the data access policy.

### 7.3 Data Analysis and Interpretation

Data collected during the SHA Survey is used to generate summary reports that present analyzed results derived from calculations done by the database. The results of data analysis are available in SHA transect and/or patch survey segment summary reports. The calculations that are performed by the database for the two surveys are described below, followed by some suggestions for interpretation of the results.

#### 7.3.1 *SHA Transect Survey Segment Summary Report*

A Transect Survey Segment Summary Report uses information from Forms 9.0, 9.1, and 9.2. The report covers one stream segment and is divided into header information, and surface area and percent of channel by substrate size class summary sections.

#### 7.3.2 *SHA Patch Survey Segment Summary Report*

A Patch Survey Segment Summary Report uses information from Forms 9.0, 9.1, and 9.3. The report covers one stream segment and is divided into header information, surface area of wetted spawning habitat, spawning habitat patch count by surface area size class, and spawning habitat patch information summary sections.

#### 7.3.3 *Data Interpretation*

Information on spawning habitat availability can be interpreted in the biological context of the salmonid species utilizing the stream segment and in the geomorphic context of the relationship between spawning habitat availability, stream channel characteristics, and watershed conditions. The following recommendations for data interpretation are intended to provide information that is useful in both contexts.

Spawning habitat availability data are commonly interpreted based on spawning gravel size preferences of the species or stocks present in each stream segment. Small-bodied salmonids are defined as species that are typically less than 35 cm long when mature, including resident rainbow, resident cutthroat, anadromous

cutthroat, bull trout (dolly varden), brown trout, brook trout, and kokanee, and are expected to only use small spawning gravel (8 mm-64 mm). Large-bodied salmonids are typically greater than 35 cm when mature, including pink, chum, coho, sockeye, steelhead, and chinook salmon, and are expected to only use both small and large spawning gravel (8 mm-128 mm).

The two SHA Surveys collect different types of information. The transect survey estimates the area of potential spawning habitat and the percentage of the channel dominated by the two size classes of spawning gravel in each monitoring segment. This information can be used as an indicator of relative spawning habitat availability for comparing stream segments, characterizing a watershed, or identifying segments for more intensive monitoring. The patch survey provides more detailed information on the actual spawning habitat available in each segment at a discharge representative of the spawning season.

Spawning habitat patch data can be used to estimate carrying capacity for various species or stocks in each stream segment. Carrying capacity estimates are based on the area of available spawning habitat, the number of potential spawning sites, and the number of eggs that could be deposited at each site (Reeves et al., 1989; Nickelson et al., 1992). This information can be used to determine if the amount of spawning habitat might be limiting salmonid production, but needs to be interpreted in the context of other factors limiting production at various stages in the life cycle. The procedure is to estimate the number of spawning sites available at the survey discharge using a minimum redd size for the species or stock of interest. Minimum redd size can be taken from the literature (such as Burner, 1951) or established by local studies. The total area of spawning habitat with the appropriate spawning gravel size could be divided by the minimum redd size to estimate the number of spawning sites available in each stream segment. A more accurate estimate could be achieved with a frequency distribution of the number of spawning patches by size class, so patches that fall below the minimum redd size could be excluded. These results are interpreted with caution due to the wide range of factors that can influence production.

Limited research indicates that spawning gravel size and abundance varies with stream channel characteristics and watershed conditions. The most important factors influencing substrate size include stream power,

sediment supply, and hydraulic roughness produced by bed form and LWD (Buffington, 1995). This issue is critical for successful interpretation of spawning habitat availability in the context of Watershed Analysis, so further study is needed to improve interpretation capabilities. In the meantime, the data analysis recommended here provides a means of quantifying the relative abundance and size class distribution of spawning gravel within stream segments, and comparing relative spawning habitat availability between stream segments.

## 8. References

- Allen, K.R. 1969. Limitations on the protection of salmonid populations in streams. Pages 3-20 IN: T.G. Northcote (ed.). Salmon and trout in streams. H.R. MacMillan lectures in fisheries. Univ. British Columbia. Vancouver.
- Benda, L., T.J. Beechie, R.C. Wissmar and A. Johnson. 1992. Morphology and evolution of salmonid habitats in a recently deglaciated river basin, Washington State, USA. Can. Jour. fish. Aquat. Sci 49: 1246-1256.
- Bjornn, T.C. and D.W. Reiser. 1991. Habitat requirements of salmonids in streams. Pages 41-82 IN: W.R. Meehan (ed.). Influences of forest and rangeland management on salmonid fishes and their habitats. American Fisheries Society Special Publication 16. Bethesda.
- Briggs, J.C. 1953. The behavior and reproduction of salmonid fishes in a small coastal stream. Fish Bull. No. 94. Calif. Dept. Fish and Game. Sacramento.
- Buffington, J. M. 1995. Effects of hydraulic roughness and sediment supply on surface textures of gravel-bedded streams. M.S. Thesis. Univ. of Washington. Seattle.
- Burgner, R.L. 1991. Life history of sockeye salmon (*Oncorhynchus nerka*). Pages 1-118 IN: C. Groot and L. Margolis (eds.). Pacific salmon life histories. University of British Columbia Press.
- Burner, 1951. Characteristics of spawning nests of Columbia River salmon. USDA Fish and Wildlife Service. Fisheries Bulletin 61 Volume 52. Washington, D.C.
- Chambers, J.S., G.H. Allen and R.T. Pressey. 1955. Research relating to study of spawning gravels in natural areas. Annual Report 1955. Wash. Dept. Fish. Olympia.
- Collins, B. and T. Dunne. 1990. Fluvial geomorphology and river-gravel mining: a guide for planners, case studies included. Special Pub. 98. California Department of Conservation Division of Mines and Geology. Sacramento.
- Crisp, D.T. and P.A. Carling. 1989. Observations on siting, dimensions, and structure of salmonid redds. J. Fish. Biol. 34:119-134.
- Curry, R.A., J. Gehrels, D.L.G. Noades and R. Swainson. 1994. Effects of river flow fluctuations on groundwater discharge through brook trout, *Salvelinus fontinalis*, spawning and incubation habitats. Hydrobiologia 227:121-134.
- Duncan, S.H. and J.W. Ward. 1985. The influence of watershed geology and forest roads on the composition of salmon spawning gravel. Northwest Science 59(3):204-212.
- Heard, W.R. 1991. Life history of pink salmon (*Oncorhynchus gorbuscha*). Pages 119-230 IN: C. Groot and L. Margolis (eds.). Pacific salmon life histories. University of British Columbia Press.
- Hoopes, D.T. 1972. Selection of spawning sites by sockeye salmon in small streams. Fishery Bulletin 70(2):447-458.
- Hunter, J.W. 1973. A discussion of game fish in the State of Washington as related to water requirements. Wash. Dept. of Game. Olympia.
- Keller, E.A. and F.J. Swanson. 1979. Effects of large organic material on channel form and fluvial processes. Earth Surface Processes Vol. 4: 361-380.

- Kondolf, G.M., G.F. Cada, M.J. Sale and R. Felando. 1991. Distribution and stability of potential salmonid spawning gravels in steep boulder-bed streams of the eastern Sierra Nevada. *Transactions of the American Fisheries Society* 120:177-186.
- Kondolf, G.M. and M.L. Swanson. 1993. Channel adjustments to reservoir construction and gravel extraction along Stony Creek, California. *Environmental Geology* 21:256-269.
- Kondolf, G.M. and M.G. Wolman. 1993. The sizes of salmonid spawning gravels. *Water Resources Research* 29(7):2275-2285.
- Leman, V.N. 1993. Spawning sites of chum salmon *Oncorhynchus keta*: micro hydrological regime and viability of progeny in redds. *Journal of Ichthyology* 33:104-117.
- McFadden, J.T. 1969. Dynamics and regulation of salmonid populations in streams. Pages 313-328 IN: T.G. Northcote (ed.). *Symposium on salmon and trout in streams*. Univ. Brit. Col. Vancouver.
- McNeil, W.J. 1964. Redd superimposition and egg capacity of pink salmon spawning beds. *Jour. Fish. Res. Bd. Canada* 21:1385-1396.
- Miller, R.J. and E.L. Brannon. 1982. The origin and development of life history patterns in Pacific salmonids. Pages 296-309 IN: E.L. Brannon and E.O. Salo (eds.). *Proceedings of the salmon and trout migratory behavior symposium*. Univ. Wash. Seattle.
- Nickelson, T.E., M.F. Sclozzi, S.L. Johnson, and J.D. Rodgers. 1992. An approach to determining stream carrying capacity and limiting habitat for coho salmon (*Oncorhynchus kisutch*). Pages 251-260 in L. Berg and P.W. Delaney (eds.) *Proceedings of the coho workshop*, Nanaimo, B.C.
- Platts, W.S. and W.F. Megahan. 1975. Time trends in riverbed sediment composition in salmon and steelhead spawning areas: South Fork Salmon River, Idaho. Pages 229-239 IN: *Transactions of the 40th North American Wildlife Conference*. Wildlife Mngt. Inst.
- Platts, W.S., R.J. Torquemada, M.L. McHenry and C.K. Graham. 1989. Changes in salmon spawning and rearing habitat from increased delivery of fine sediment to the South Fork Salmon River, Idaho. *Trans. Amer. Fish. Soc.* 118: 274-283.
- Pleus, A.E. 1999. TFW Monitoring Program methods manual for wadable stream discharge measurement. Prepared for the Washington State Dept. of Natural Resources under the Timber, Fish, and Wildlife Agreement. TFW-AM9-99-009. DNR #111.
- Pleus, A.E., and D. Schuett-Hames. 1998a. TFW Monitoring Program methods manual for stream segment identification. Prepared for the Washington State Dept. of Natural Resources under the Timber, Fish, and Wildlife Agreement. TFW-AM9-98-001. DNR #103.
- Pleus, A.E., and D. Schuett-Hames. 1998b. TFW Monitoring Program methods manual for the reference point survey. Prepared for the Washington State Dept. of Natural Resources under the Timber, Fish, and Wildlife Agreement. TFW-AM9-98-002. DNR #104.
- Pleus, A.E., D. Schuett-Hames, and L. Bullchild. 1999. TFW Monitoring Program methods manual for the habitat unit survey. Prepared for the Washington State Dept. of Natural Resources under the Timber, Fish, and Wildlife Agreement. TFW-AM9-99-003. DNR #105.

- Reeves, G.H., F.H. Everest and T.E. Nickelson. 1989. Identification of physical habitats limiting the production of coho salmon in western Oregon and Washington. USDA For. Serv. Gen. Tech. Rpt. PNW-GTR-245. Pac. Northwest Res. Stat. Portland.
- Schroder, S.L. 1973. Effects of density on spawning success of chum salmon *Oncorhynchus keta* in an artificial spawning channel. MS Thesis. Univ. of Wash. Seattle.
- Schuett-Hames, D., and A.E. Pleus. 1996. TFW Ambient Monitoring Program literature review and monitoring recommendations for salmonid spawning habitat availability. Prepared for the Washington State Dept. of Natural Resources under the Timber, Fish, and Wildlife Agreement. TFW-AM9-96-002. DNR #83. 32 p.
- Semenchenko, N.N. 1989. Mechanisms of innate population control in sockeye salmon. *Jour. Ichthyology* 28(3):149-157.
- Smith, A.K. 1973. Development and application of spawning velocity and depth criteria for Oregon salmonids. *Transactions of the American Fisheries Society* 102(2):312-316.
- Sowden, T.K. and G. Power. 1985. Prediction of rainbow trout embryo survival in relation to groundwater seepage and particle size of spawning substrate. *Trans. Am. Fish. Soc.* 114:804-812.
- Vaux, W.G. 1962. Interchange of stream and intragravel water in a salmon spawning riffle. USDI Fish and Wildlife Service. Spec. Sci. Rpt. Fisheries No. 405. Washington, D.C.
- Washington Forest Practices Board (WFPB), 1996. Washington Forest Practices - Board Manual: standard methodology for conducting Watershed Analysis under chapter 222-22 WAC. Version 3.1. Prepared by the Dept. Nat. Resources Forest Practices Div. Olympia.
- Webster, D.A. and G. Eiriksdottir. 1976. Upwelling water as a factor influencing choice of spawning sites by brook trout (*Salvelinus fontinalis*). *Trans. Amer. Fish. Soc.* 105:416-421.
- Wendler, H.O. and G. Deschamps. 1955. Logging dams on coastal Washington streams. Washington Department of Fisheries Research Papers Vol.1, No. 3. Olympia.

---

## 9. Appendixes

### **Appendix A**

Form 9.0, 9.1, 9.2, and 9.3 Copy Masters

### **Appendix B**

Examples of Completed Field Forms 9.0, 9.1, 9.2, and 9.3

### **Appendix C**

SHA Criteria and Code Field Sheet Copy Master

### **Appendix D**

Data Management Examples

### **Appendix E**

Standard Field and Vehicle Gear Checklist Copy Master





# **Appendix A**

**Form 9.0, 9.1, 9.2, and 9.3 Copy Masters**

**(Keep original copy master with manual)**



# SHA SURVEY

## HEADER INFORMATION

# FORM 9.0

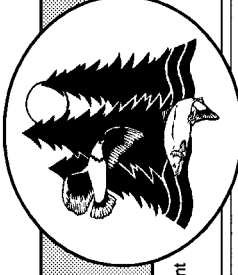

WRIA # \_\_\_\_\_ Unlisted Trib  RB  Segment # \_\_\_\_\_ Date \_\_\_\_/\_\_\_\_/\_\_\_\_

### Study Design Information

Begin Survey Date \_\_\_\_/\_\_\_\_/\_\_\_\_

Survey Length \_\_\_\_\_

- Survey Coverage Percentage**
- WHL (Whole) 100 %
  - SUB (Sub-sample) \_\_\_\_\_ %
  - PRT (Partial) \_\_\_\_\_ %
  - PSB (Partial Sub-sample) \_\_\_\_\_ %

Partial/Other Survey Location  
WRIA River Mile: \_\_\_\_\_ from \_\_\_\_\_ to \_\_\_\_\_

### Sample Method Information

- Core**
- Transect
  - Transect + Wet

Transect Intervals

TFW  
 Mod. TFW

### Discharge Information

Date \_\_\_\_/\_\_\_\_/\_\_\_\_  CMS

Date \_\_\_\_/\_\_\_\_/\_\_\_\_

Date \_\_\_\_/\_\_\_\_/\_\_\_\_

Sub-Segment \_\_\_\_\_

**Survey Crew**

Name \_\_\_\_\_ Affiliation \_\_\_\_\_ (Lead) \_\_\_\_\_ (Rec.) \_\_\_\_\_

Crew Lead: Year of most recent SHA \_\_\_\_\_ Training \_\_\_\_\_ QA Review \_\_\_\_\_

### Survey Notes

\_\_\_\_\_  
\_\_\_\_\_  
\_\_\_\_\_  
\_\_\_\_\_  
\_\_\_\_\_  
\_\_\_\_\_  
\_\_\_\_\_  
\_\_\_\_\_  
\_\_\_\_\_

| Equipment <input type="radio"/> Metric <input type="radio"/> | Type | Size | Cond | Accu- | Pre- | Post- |
|--|------|------|------|-------|------|-------|
|  |      |      |      |       |      |       |
|  |      |      |      |       |      |       |
|  |      |      |      |       |      |       |
|  |      |      |      |       |      |       |
|  |      |      |      |       |      |       |
|  |      |      |      |       |      |       |
|  |      |      |      |       |      |       |
|  |      |      |      |       |      |       |

continued page \_\_\_\_\_

Form 9.0  
Error Checked by: \_\_\_\_\_ Date: \_\_\_\_/\_\_\_\_/\_\_\_\_  
All Field Forms  
Error Checked by: \_\_\_\_\_ Date: \_\_\_\_/\_\_\_\_/\_\_\_\_  
All Data Entry



Stream Name \_\_\_\_\_

**SHA SURVEY**

**CHANNEL**

**METERS**

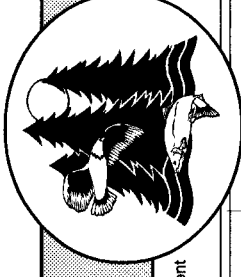

**FORM 9.1**

WRIA # \_\_\_\_\_ Unlisted Trib  RB  Segment # \_\_\_\_\_ Date \_\_\_\_\_ / \_\_\_\_\_ / \_\_\_\_\_ Sub-Segment \_\_\_\_\_

| Tran | CUM Dist | BFW | WETTED  |             | Field Notes | Tran | CUM Dist | BFW         | WETTED  |             | Field Notes |
|------|----------|-----|---|-------------|-------------|------|----------|-------------|---|-------------|-------------|
|      |          |     | Width Measurements<br>(Single or Cumulative only) | ( ) ( ) ( ) |             |      |          |             | Width Measurements<br>(Single or Cumulative only) | ( ) ( ) ( ) |             |
|      |          |     | ( ) ( ) ( )                                       | ( ) ( ) ( ) |             |      |          | ( ) ( ) ( ) | ( ) ( ) ( )                                       |             |             |
|      |          |     | ( ) ( ) ( )                                       | ( ) ( ) ( ) |             |      |          | ( ) ( ) ( ) | ( ) ( ) ( )                                       |             |             |
|      |          |     | ( ) ( ) ( )                                       | ( ) ( ) ( ) |             |      |          | ( ) ( ) ( ) | ( ) ( ) ( )                                       |             |             |
|      |          |     | ( ) ( ) ( )                                       | ( ) ( ) ( ) |             |      |          | ( ) ( ) ( ) | ( ) ( ) ( )                                       |             |             |
|      |          |     | ( ) ( ) ( )                                       | ( ) ( ) ( ) |             |      |          | ( ) ( ) ( ) | ( ) ( ) ( )                                       |             |             |
|      |          |     | ( ) ( ) ( )                                       | ( ) ( ) ( ) |             |      |          | ( ) ( ) ( ) | ( ) ( ) ( )                                       |             |             |
|      |          |     | ( ) ( ) ( )                                       | ( ) ( ) ( ) |             |      |          | ( ) ( ) ( ) | ( ) ( ) ( )                                       |             |             |
|      |          |     | ( ) ( ) ( )                                       | ( ) ( ) ( ) |             |      |          | ( ) ( ) ( ) | ( ) ( ) ( )                                       |             |             |
|      |          |     | ( ) ( ) ( )                                       | ( ) ( ) ( ) |             |      |          | ( ) ( ) ( ) | ( ) ( ) ( )                                       |             |             |
|      |          |     | ( ) ( ) ( )                                       | ( ) ( ) ( ) |             |      |          | ( ) ( ) ( ) | ( ) ( ) ( )                                       |             |             |
|      |          |     | ( ) ( ) ( )                                       | ( ) ( ) ( ) |             |      |          | ( ) ( ) ( ) | ( ) ( ) ( )                                       |             |             |
|      |          |     | ( ) ( ) ( )                                       | ( ) ( ) ( ) |             |      |          | ( ) ( ) ( ) | ( ) ( ) ( )                                       |             |             |
|      |          |     | ( ) ( ) ( )                                       | ( ) ( ) ( ) |             |      |          | ( ) ( ) ( ) | ( ) ( ) ( )                                       |             |             |
|      |          |     | ( ) ( ) ( )                                       | ( ) ( ) ( ) |             |      |          | ( ) ( ) ( ) | ( ) ( ) ( )                                       |             |             |
|      |          |     | ( ) ( ) ( )                                       | ( ) ( ) ( ) |             |      |          | ( ) ( ) ( ) | ( ) ( ) ( )                                       |             |             |









# SHA SURVEY

# PATCH DATA

# FORM 9.3

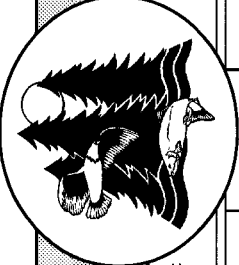

METERS

| WRIA # _____ |          | Unlisted Trib <input type="radio"/> RB <input type="radio"/> |                 | Segment # _____                                       | Sub-Segment _____ |                          | Date ____ / ____ / ____ |             |
|--------------|----------|--|-----------------|---|-------------------|--------------------------|-------------------------|-------------|
| SUB Patch    | DWN Tran | DOM SG Chan (S-L)  | SIDE Chan (Y-N) | PATCH Length Measurements (Single or Cumulative only) | PATCH Length      | PATCH Width Measurements |                         | Field Notes |
|              |          |  |                 |   |                   | Width                    | Width                   |             |
|              |          |  |                 | ( ) ( ) ( )   |                   | ( ) ( ) ( )              |                         |             |
|              |          |  |                 | ( ) ( ) ( )   |                   | ( ) ( ) ( )              |                         |             |
|              |          |  |                 | ( ) ( ) ( )   |                   | ( ) ( ) ( )              |                         |             |
|              |          |  |                 | ( ) ( ) ( )   |                   | ( ) ( ) ( )              |                         |             |
|              |          |  |                 | ( ) ( ) ( )   |                   | ( ) ( ) ( )              |                         |             |
|              |          |  |                 | ( ) ( ) ( )   |                   | ( ) ( ) ( )              |                         |             |
|              |          |  |                 | ( ) ( ) ( )   |                   | ( ) ( ) ( )              |                         |             |
|              |          |  |                 | ( ) ( ) ( )   |                   | ( ) ( ) ( )              |                         |             |
|              |          |  |                 | ( ) ( ) ( )   |                   | ( ) ( ) ( )              |                         |             |
|              |          |  |                 | ( ) ( ) ( )   |                   | ( ) ( ) ( )              |                         |             |
|              |          |  |                 | ( ) ( ) ( )   |                   | ( ) ( ) ( )              |                         |             |
|              |          |  |                 | ( ) ( ) ( )   |                   | ( ) ( ) ( )              |                         |             |
|              |          |  |                 | ( ) ( ) ( )   |                   | ( ) ( ) ( )              |                         |             |
|              |          |  |                 | ( ) ( ) ( )   |                   | ( ) ( ) ( )              |                         |             |
|              |          |  |                 | ( ) ( ) ( )   |                   | ( ) ( ) ( )              |                         |             |
|              |          |  |                 | ( ) ( ) ( )   |                   | ( ) ( ) ( )              |                         |             |
|              |          |  |                 | ( ) ( ) ( )   |                   | ( ) ( ) ( )              |                         |             |
|              |          |  |                 | ( ) ( ) ( )   |                   | ( ) ( ) ( )              |                         |             |
|              |          |  |                 | ( ) ( ) ( )   |                   | ( ) ( ) ( )              |                         |             |
|              |          |  |                 | ( ) ( ) ( )   |                   | ( ) ( ) ( )              |                         |             |
|              |          |  |                 | ( ) ( ) ( )   |                   | ( ) ( ) ( )              |                         |             |
|              |          |  |                 | ( ) ( ) ( )   |                   | ( ) ( ) ( )              |                         |             |
|              |          |  |                 | ( ) ( ) ( )   |                   | ( ) ( ) ( )              |                         |             |



# **Appendix B**

**Completed Examples of  
Forms 9.0, 9.1, 9.2, and 9.3**



# SHA SURVEY

# HEADER INFORMATION

# FORM 9.0



**WRIA #** 130029    Unlisted Trib  RB  LB    **Segment #** 2    **Date** 7/12/99  
 Sub-Segment Code 6

**Study Design Information**  
 Begin Survey Date 7/14/99  
 End Survey Date 7/20/99  
 Survey Length 1700 m  
 Survey Coverage  
 WHL (Whole)    100 %  
 SUB (Sub-sample)    %  
 PRT (Partial)    %  
 PSB (Partial Sub-sample)    %  
 OTH (Other)    %

**Sample Method Information**  
 Core  
 Survey Coverage  
 Transect  
 Transect + Wet  
 Patch  
 Transect Intervals 50 m  
 TFW  
 Mod. TFW  
 Non-TFW

**Study Design Information**  
 Partial/Other Survey Location from    to     
 WRIA River Mile: from    to     
 Reference Points: from    to   

**Discharge Information**  
 Date 7/14/99    0.24     CMS  
 Date    /    /        CFS  
 Date    /    /        CFS

**Survey Crew**  
 Name ALLEN PLEUS    Affiliation TFW-MP @ NWIFC (Lead)  
SUE MADSEN    RR RESOURCE CONS (Rec.)  
 Crew Lead: Year of most recent SHA 199    Training 199    QA Review 199

**Survey Notes**  
\* EXAMPLE DATA \*

| FORM | TOTAL # Pages |
|------|---------------|
| 9.1  | 2             |
| 9.2  | 11            |
| 9.3  | 23            |

| Equipment       | Metric <input checked="" type="radio"/> English <input type="radio"/> | Type        | Size | Cond | Accuracy | Pre-Calibrated | Post-Calibrated |
|-----------------|---|-------------|------|------|----------|----------------|-----------------|
| HIP CHAIN       | ID# H4  | CHAINMAN II | STND | GOOD | ± 2%     | 5/20/99        | 9/30/99         |
| FIBERGLASS TAPE | #038  | KESON       | 30.0 |      | ± 0.01   |                |                 |
| STADIA ROD      | #007  | MOUND CITY  | 5.0  |      | ± 0.01   |                |                 |
| CALIPER         | #114  | VERNIER     | 8"   |      | ± 1 mm   |                |                 |
| TORPEDO LEVEL   |   |             |      |      |          |                |                 |
| HIP BOOTS       |   |             |      |      |          |                |                 |

Form 9.0  
 Error Checked by: AP    Date: 7/23/99  
 All Field Forms  
 Error Checked by: AP    Date: 7/23/99  
 All Data Entry  
 Error Checked by: AP    Date: 8/1/99

continued page



TFW Monitoring Program Stream Name PERCIVAL CREEK

**SHA SURVEY**

**CHANNEL WIDTH DATA**

METERS  
 FEET

**FORM 9.1**

WRIA # 130029 Unlisted Trib  RB  LB  
 Segment # 2 Sub-Segment Code b  
 Date 7/14/99

| Tran # | CUM Dist | BFW                   | WETTED   |   | Width (Total) | Field Notes | Field Notes                |
|--------|----------|-----------------------|--|---|---------------|-------------|----------------------------|
|        |          |                       | Width Measurements (Single or Cumulative only) | WETTED Width Measurements (Single or Cumulative only) |               |             |                            |
| 1      | 0        | 12.2                  | (4.7)( )<br>( ) ( )                            | ( ) ( )   | 4.7           |             |                            |
| 2      | 50       | 11.7                  | (3.9)(2.6)<br>( ) ( )                          | ( ) ( )   | 6.5           |             |                            |
| 3      | 100      | 9.4                   | (4.0)( <del>2.1</del> )<br>( ) ( )             | ( ) ( )   | 4.0           |             |                            |
|        |          | 3.6                   | (2.1)( )<br>( ) ( )                            | ( ) ( )   | 2.1           |             |                            |
|        |          | 13.0                  | ( ) ( )<br>( ) ( )                             | ( ) ( )   | 6.1           |             |                            |
| 4      | 150      | 14.1                  | (3.2)(2.1)(1.4)<br>( ) ( )                     | ( ) ( )   | 6.7           |             |                            |
| 5      | 200      | 10.5                  | (8.2)( )<br>( ) ( )                            | ( ) ( )   | 8.2           |             |                            |
| 6      | 250      | 10.9                  | (4.3)( )<br>( ) ( )                            | ( ) ( )   | 4.3           |             |                            |
| 7      | 300      | 13.0                  | (5.0)( )<br>( ) ( )                            | ( ) ( )   | 5.0           |             |                            |
| 8      | 350      | 7.8<br><del>8.4</del> | (4.7)( )<br>( ) ( )                            | ( ) ( )   | 4.7           |             |                            |
|        |          | 4.4                   | (3.2)( )<br>( ) ( )                            | ( ) ( )   | 3.2           |             |                            |
|        |          | 3.7                   | ( ) ( )<br>( ) ( )                             | ( ) ( )   | -             |             |                            |
|        |          | 15.9                  | ( ) ( )<br>( ) ( )                             | ( ) ( )   | 7.9           |             |                            |
| 9      | 400      | 12.6                  | (6.1)( )<br>( ) ( )                            | ( ) ( )   | 6.1           |             |                            |
| 10     | 450      | 11.9                  | (2.6)(3.9)<br>( ) ( )                          | ( ) ( )   | 6.5           |             | UNDERCUT BANK<br>WW ± 0.5m |
| 11     | 500      | 11.1                  | (1.0)(4.7)<br>( ) ( )                          | ( ) ( )   | 5.7           |             |                            |
| 12     | 550      | 10.8                  | (6.0)( )<br>( ) ( )                            | ( ) ( )   | 6.0           |             | LWD                        |
| 13     | 600      | 7.2                   | (5.6)( )<br>( ) ( )                            | ( ) ( )   | 5.6           |             | M.C.                       |
|        |          | 5.7                   | (3.1)( )<br>( ) ( )                            | ( ) ( )   | 3.1           |             |                            |
| 14     | 650      | 9.6                   | ( ) ( )<br>( ) ( )                             | ( ) ( )   | 8.7           |             | TOTAL                      |
| 14     | 650      | 9.6                   | (4.7)( )<br>( ) ( )                            | ( ) ( )   | 4.7           |             | BRIDGE SUPPORTS            |
| 15     | 700      | 10.3                  | (7.1)( )<br>( ) ( )                            | ( ) ( )   | 7.1           |             |                            |
| 16     | 750      | 9.9                   | (6.3)( )<br>( ) ( )                            | ( ) ( )   | 6.3           |             |                            |
| 17     | 800      | 11.4                  | (5.4)( )<br>( ) ( )                            | ( ) ( )   | 5.4           |             |                            |
| 18     | 850      | 13.7                  | (3.6)(0.5)(5.3)<br>( ) ( )                     | ( ) ( )   | 9.4           |             | LWD JAM - LOOSE            |
| 19     | 900      | 15.1                  | (10.1)( )<br>( ) ( )                           | ( ) ( )   | 10.1          |             | POOL                       |
| 20     | 950      | 12.2                  | (6.3)( )<br>( ) ( )                            | ( ) ( )   | 6.3           |             |                            |
| 21     | 1000     | 12.5                  | (6.1)( )<br>( ) ( )                            | ( ) ( )   | 6.1           |             |                            |









Stream Name PERCIVAL CREEK

**SHA SURVEY**

**PATCH DATA**

METERS  
 FEET

**FORM 9.3**

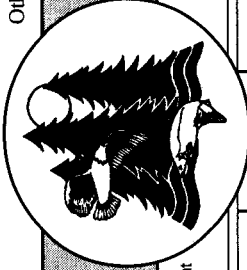

WRIA # 130029 Unlisted Trib  RB  LB  Sub-Segment Code 6 Segment # 2 Date 7/14/99

| Patch # | SUB Patch # | DWN Tran # | DOM SG (S-L) | SIDE Chan (Y-N) | PATCH Length Measurements |                   | PATCH Width Measurements |              | Width (Average) | HAB TYPE | Field Notes    |
|---------|-------------|------------|--------------|-----------------|---------------------------|-------------------|--------------------------|--------------|-----------------|----------|----------------|
|         |             |            |              |                 | (Single)                  | (Cumulative only) | (Single)                 | (Cumulative) |                 |          |                |
| 1       | 1           | 1          | S            | N               | (9.9)                     | ( )               | (5.9)                    | (5.6)        | 5.8             | R        | EXAMPLE DATA * |
| 1       | 2           | 1          | S            | N               | (10.6)                    | ( )               | (1.6)                    | (1.1)        | 1.7             | R        |                |
| 1       | 3           | 1          | S            | N               | (6.9)                     | ( )               | (1.5)                    | (2.3)        | 1.9             | P        |                |
| 1       | 4           | 1          | S            | N               | (9.7)                     | ( )               | (1.5)                    | (1.9)        | 1.5             | P        |                |
| 2       | 1           | 1          | L            | N               | (2.0)                     | ( )               | (1.4)                    | (1.2)        | 1.1             | P        |                |
| 1       | 5           | 1          | S            | N               | (4.2)                     | ( )               | (1.4)                    | (1.0)        | 1.2             | R        |                |
| 3       | 1           | 1          | S            | N               | (8.4)                     | ( )               | (4.0)                    | (4.3)        | 3.1             | R        |                |
| 4       | 1           | 1          | L            | N               | (4.1)                     | ( )               | (2.2)                    | (2.0)        | 2.0             | R        |                |
| 5       | 1           | 1          | S            | N               | (3.7)                     | ( )               | (2.1)                    | (1.7)        | 3.0             | R        |                |
| 5       | 2           | 2          | S            | N               | (6.3)                     | ( )               | (3.1)                    | (2.9)        | 2.0             | R        |                |
| 6       | 1           | 1          | L            | N               | (5.3)                     | ( )               | (2.4)                    | (1.5)        | 4.1             | C        | -> 4% Gradient |
| 7       | 1           | 1          | S            | N               | (2.7)                     | ( )               | (4.6)                    | (3.7)        | 2.5             | R        |                |
| 8       | 1           | 1          | S            | N               | (2.1)                     | ( )               | (2.4)                    | (2.6)        | 0.8             | P        |                |
| 8       | 2           | 2          | S            | N               | (1.5)                     | ( )               | (1.1)                    | (0.5)        | 1.1             | P        |                |



# **Appendix C**

**SHA Criteria & Code Field Sheet Copy Master**

**(Keep original copy master with manual)**



# SHA Survey Criteria & Code Field Sheet

| Segment Length | Transect Interval (m) |
|----------------|-----------------------|
| < 100          | 10% of length         |
| ≥ 100 - 500    | 25                    |
| ≥ 500 - 2500   | 50                    |
| ≥ 2500         | 100                   |

| Particle Size Class           | Size Range (mm)            | Code # |
|-------------------------------|----------------------------|--------|
| Silt/Sand                     | < 8                        | 1      |
| Small Spawning Gravel         | ≥ 8 to 64                  | 2      |
| Large Spawning Gravel         | ≥ 64 to 128                | 3      |
| Boulders                      | ≥ 128                      | 4      |
| Bedrock                       | ≥ 1 m <sup>2</sup> Exposed | 5      |
| Other (LWD, Clay, Peat, etc.) | ≥ 0.5 m                    | 6      |

| Patch Length | Minimum # Paces per Width Meas. |
|--------------|---------------------------------|
| < 2.5 to 5 m | 1 step                          |
| ≥ 5 to 10 m  | 2 steps                         |
| ≥ 10 to 20 m | 3 steps                         |
| ≥ 20 m       | 4 steps                         |

| Minimum Patch Criteria  |                    |
|-------------------------|--------------------|
| Dominant Substrate Size | ≥ 8 to < 128 mm    |
| Substrate Depth         | ≥ 23 cm            |
| Water Depth             | ≥ 10 cm            |
| Water Velocity          | > Slack            |
| Patch Size              | ≥ 1 m <sup>2</sup> |

**Small (S) Spawning Gravel Size:** ≥ 8 to < 64 mm  
**Large (L) Spawning Gravel Size:** ≥ 64 to < 128 mm

**Side Channel Criteria**

Channel must be Separated from Primary Low Flow Channel by an Island

*Island:*

- length of the island above the bankfull channel is 2 times the estimated bankfull width; and
- vegetated by two or more perennial plants that are greater than 2 meters in height.

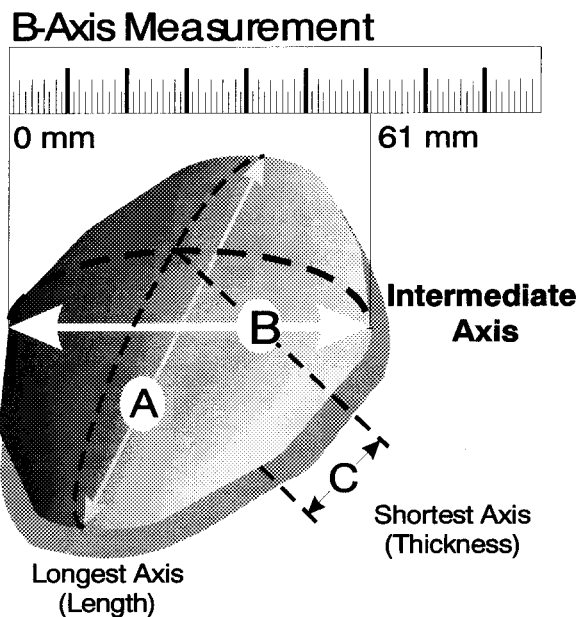

**Lumpers & Splitters**

> Disregard wetted depth criteria and lump patch width to the wetted edge where the minimum water depth is within:

- \*\* 0.5 meters (Segment Mean BFW < 10 m); or
- \*\* 1.0 meters (Segment Mean BFW ≥ 10 m)

> Split patch units: use same Patch # and next sequential Sub-Patch # :

- \*\* at Reference Points
- \*\* where they cross into a side channel
- \*\* where splitting can significantly improve surface area measurement accuracy

> QA Note: Patch boundary ID is largest variability factor between crews. To reduce:

- Do easy parts first
- Use confidence/default technique
- Mark boundaries with weighted or wire flags

Approximate B-Axis Size Classes  
 (NOT FOR MEASUREMENT USE)

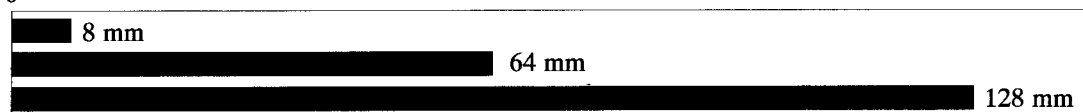





# **Appendix D**

## **Data Management Examples**

- D-1: Excel Header, Width, Transect, and Patch Data Entry Sheets**
- D-2: SHA Transect Survey Segment Summary Report**
- D-3: SHA Patch Survey Segment Summary Report**



**EXAMPLE: Excel Data Entry Spreadsheet Fields**

\*\*Examples show column headers only for each type entry file

**TFW Monitoring Program**

**Spawning Habitat Availability Survey Header**

**Form 9.0**

shahd.xls

|            |             |      |      |          |                   |                 |                  |                |              |            |               |
|------------|-------------|------|------|----------|-------------------|-----------------|------------------|----------------|--------------|------------|---------------|
| wria basin | wria stream | trib | segm | sub segm | begin survey date | end survey date | begin river mile | end river mile | begin ref pt | end ref pt | survey length |
|------------|-------------|------|------|----------|-------------------|-----------------|------------------|----------------|--------------|------------|---------------|

>>>>

|                 |                |                   |                  |              |                |               |                |             |              |              |
|-----------------|----------------|-------------------|------------------|--------------|----------------|---------------|----------------|-------------|--------------|--------------|
| survey coverage | survey percent | leader first name | leader last name | leader affil | recorder first | recorder last | recorder affil | field notes | disch 1 date | disch 1 flow |
|-----------------|----------------|-------------------|------------------|--------------|----------------|---------------|----------------|-------------|--------------|--------------|

>>>>

|              |              |              |              |
|--------------|--------------|--------------|--------------|
| disch 2 date | disch 2 flow | disch 3 date | disch 3 flow |
|--------------|--------------|--------------|--------------|

**TFW Monitoring Program**

**Spawning Habitat Availability Survey - Width Data**

**Form 9.1**

shawdata.xls

|            |             |      |      |         |                   |             |              |                     |                  |                |              |
|------------|-------------|------|------|---------|-------------------|-------------|--------------|---------------------|------------------|----------------|--------------|
| wria basin | wria stream | trib | segm | subsegm | begin survey date | survey date | transect num | cumulative distance | downstream refpt | bankfull width | wetted width |
|------------|-------------|------|------|---------|-------------------|-------------|--------------|---------------------|------------------|----------------|--------------|

**TFW Monitoring Program**

**Spawning Habitat Availability Survey Data - Transect Method**

**Form 9.2**

shatdata.xls

|            |             |      |      |         |                   |              |                  |                  |                  |                       |         |             |
|------------|-------------|------|------|---------|-------------------|--------------|------------------|------------------|------------------|-----------------------|---------|-------------|
| wria basin | wria stream | trib | segm | subsegm | begin survey date | transect num | beg tape reading | end tape reading | trans unit width | sub-strate size class | dry/wet | field notes |
|------------|-------------|------|------|---------|-------------------|--------------|------------------|------------------|------------------|-----------------------|---------|-------------|

**TFW Monitoring Program**

**Spawning Habitat Availability Survey Data - Patch Method**

**Form 9.3**

shapdata.xls

|            |             |      |      |          |                   |             |           |               |         |                    |                     |            |
|------------|-------------|------|------|----------|-------------------|-------------|-----------|---------------|---------|--------------------|---------------------|------------|
| wria basin | wria stream | trib | segm | sub segm | begin survey date | survey date | patch num | sub-patch num | dwn rfp | side channel (y/n) | dominant subs (S/L) | avg length |
|------------|-------------|------|------|----------|-------------------|-------------|-----------|---------------|---------|--------------------|---------------------|------------|

>>>>

|           |             |
|-----------|-------------|
| avg width | field notes |
|-----------|-------------|



# TFW Monitoring

## Spawning Habitat Availability Transect Survey

### Segment Summary Report

---

Stream Name: KENNEDY CREEK

WRIA: 14.0012.000

Survey Date: 01/01/1999 To 01/01/1999

Segment: 7      sub: 0

Reference Points:      0 to 40

Svy Length/Coverage: 4,000.0 / whl

River Miles:      3.700 to 4.100

Survey Leader: John Doe

Discharge    Date      Flow

Affiliation: NWIFC

1      01/01/1999    0.05

2

3

#### Surface Area and Percent of Channel by Substrate Size Class

|                                     | Total<br>Surface<br>Area (m <sup>2</sup> ) | Small<br>Spawning<br>Gravel | Large<br>Spawning<br>Gravel | Total<br>Spawning<br>Gravel | Silt/Sand<br>Substrate | Boulder<br>Substrate | Bedrock<br>Substrate | Other<br>(clay,<br>peat, etc.) |
|-------------------------------------|--|-----------------------------|-----------------------------|-----------------------------|------------------------|----------------------|----------------------|--------------------------------|
| <b>Wetted Channel</b>               |  |                             |                             |                             |                        |                      |                      |                                |
| <b>Surface Area (m<sup>2</sup>)</b> | 50,925.00                                  | 22,362.72                   | 5,682.93                    | 28,045.65                   | 7,823.26               | 5,978.15             | 8,044.67             | 1,033.26                       |
| <b>Percent</b>                      |  | 0.44                        | 0.11                        | 0.55                        | 0.15                   | 0.12                 | 0.16                 | 0.02                           |
| <b>Bankfull Channel</b>             |  |                             |                             |                             |                        |                      |                      |                                |
| <b>Surface Area (m<sup>2</sup>)</b> | 61,700.00                                  | 26,780.43                   | 5,776.17                    | 32,556.60                   | 13,521.49              | 7,548.40             | 7,154.57             | 918.94                         |
| <b>Percent</b>                      |  | 0.43                        | 0.09                        | 0.53                        | 0.22                   | 0.12                 | 0.12                 | 0.01                           |



# TFW Monitoring

## Spawning Habitat Availability Patch Survey

### Segment Summary Report

---

#### Spawning Habitat Patch Information

Patch Number 4 Spawning Gravel Size Class small spawning gravel Surface Area (m2) 7.40

Patch Size Class 5-10

| SubPatch Number | SubPatch Surface Area (m2) | Downstream Reference Point | Side Channel |
|-----------------|----------------------------|----------------------------|--------------|
| 0               | 7.4                        | 3                          | n            |

Patch Number 5 Spawning Gravel Size Class small spawning gravel Surface Area (m2) 25.83

Patch Size Class > 20

| SubPatch Number | SubPatch Surface Area (m2) | Downstream Reference Point | Side Channel |
|-----------------|----------------------------|----------------------------|--------------|
| 0               | 25.83                      | 3                          | n            |

Patch Number 6 Spawning Gravel Size Class small spawning gravel Surface Area (m2) 112.23

Patch Size Class > 20

| SubPatch Number | SubPatch Surface Area (m2) | Downstream Reference Point | Side Channel |
|-----------------|----------------------------|----------------------------|--------------|
| 0               | 112.23                     | 3                          | n            |

Patch Number 7 Spawning Gravel Size Class small spawning gravel Surface Area (m2) 23.45

Patch Size Class > 20

| SubPatch Number | SubPatch Surface Area (m2) | Downstream Reference Point | Side Channel |
|-----------------|----------------------------|----------------------------|--------------|
| 0               | 23.45                      | 4                          | n            |

Patch Number 8 Spawning Gravel Size Class small spawning gravel Surface Area (m2) 5.28

Patch Size Class 5-10

| SubPatch Number | SubPatch Surface Area (m2) | Downstream Reference Point | Side Channel |
|-----------------|----------------------------|----------------------------|--------------|
| 0               | 5.28                       | 4                          | n            |

Patch Number 9 Spawning Gravel Size Class small spawning gravel Surface Area (m2) 127.40

Patch Size Class > 20

| SubPatch Number | SubPatch Surface Area (m2) | Downstream Reference Point | Side Channel |
|-----------------|----------------------------|----------------------------|--------------|
| 0               | 127.4                      | 4                          | n            |





# TFW Monitoring

## Spawning Habitat Availability Patch Survey

### Segment Summary Report

---

#### Spawning Habitat Patch Information

Patch Number 11 Spawning Gravel Size Class small spawning gravel Surface Area (m2) 19.76

Patch Size Class 15-20

| SubPatch<br>Number | SubPatch<br>Surface Area<br>(m2) | Downstream<br>Reference<br>Point | Side<br>Channel |
|--------------------|----------------------------------|----------------------------------|-----------------|
| 0                  | 19.76                            | 5                                | n               |

Patch Number 12 Spawning Gravel Size Class small spawning gravel Surface Area (m2) 12.60

Patch Size Class 10-15

| SubPatch<br>Number | SubPatch<br>Surface Area<br>(m2) | Downstream<br>Reference<br>Point | Side<br>Channel |
|--------------------|----------------------------------|----------------------------------|-----------------|
| 0                  | 12.6                             | 5                                | n               |

Patch Number 13 Spawning Gravel Size Class small spawning gravel Surface Area (m2) 9.15

Patch Size Class 5-10

| SubPatch<br>Number | SubPatch<br>Surface Area<br>(m2) | Downstream<br>Reference<br>Point | Side<br>Channel |
|--------------------|----------------------------------|----------------------------------|-----------------|
| 0                  | 9.15                             | 6                                | n               |

Patch Number 14 Spawning Gravel Size Class small spawning gravel Surface Area (m2) 40.89

Patch Size Class > 20

| SubPatch<br>Number | SubPatch<br>Surface Area<br>(m2) | Downstream<br>Reference<br>Point | Side<br>Channel |
|--------------------|----------------------------------|----------------------------------|-----------------|
| 0                  | 40.89                            | 6                                | n               |

Patch Number 2 Spawning Gravel Size Class small spawning gravel Surface Area (m2) 29.77

Patch Size Class > 20

| SubPatch<br>Number | SubPatch<br>Surface Area<br>(m2) | Downstream<br>Reference<br>Point | Side<br>Channel |
|--------------------|----------------------------------|----------------------------------|-----------------|
| 1                  | 14.55                            | 1                                | n               |
| 2                  | 5.5                              | 1                                | n               |
| 3                  | 9.72                             | 1                                | n               |

Patch Number 3 Spawning Gravel Size Class small spawning gravel Surface Area (m2) 152.11

Patch Size Class > 20

| SubPatch<br>Number | SubPatch<br>Surface Area<br>(m2) | Downstream<br>Reference<br>Point | Side<br>Channel |
|--------------------|----------------------------------|----------------------------------|-----------------|
| 1                  | 127.41                           | 2                                | y               |
| 2                  | 12.4                             | 2                                | n               |
| 3                  | 12.3                             | 2                                | n               |



# TFW Monitoring Spawning Habitat Availability Patch Survey Segment Summary Report

Stream Name: KENNEDY CREEK

WRIA: 14.0012.000

Survey Date: 01/01/1999 To 01/01/1999

Segment: 7 sub: 0

Reference Points: 0 to 40  
River Miles: 3.700 to 4.100

Svy Length/Coverage: 4,000.0 / whl  
Survey Leader: John Doe  
Affiliation: NWIFC

| Discharge | Date       | Flow |
|-----------|------------|------|
| 1         | 01/01/1999 | 0.05 |
| 2         |            |      |
| 3         |            |      |

### Surface Area of Wetted Spawning Habitat

| DwnStr Refpt #       | Length (m) | Mean Wetted Width (m) | Wetted Surface Area (m2) | Surface Area of Actual Spawning Habitat (m2) |              |               |
|----------------------|------------|-----------------------|--------------------------|--|--------------|---------------|
|                      |            |                       |                          | Small Gravel                                 | Large Gravel | Total Gravel  |
| 0                    | 100        | 12.15                 | 1,215.00                 | 88.55  |              | 88.55         |
| 1                    | 100        | 9.65                  | 965.00                   | 24.27  | 5.5          | 29.77         |
| 2                    | 100        | 11.30                 | 1,130.00                 | 139.71                                       | 12.4         | 152.11        |
| 3                    | 100        | 14.25                 | 1,425.00                 | 119.63                                       | 25.83        | 145.46        |
| 4                    | 100        | 13.55                 | 1,355.00                 | 156.13                                       |              | 156.13        |
| 5                    | 100        | 14.40                 | 1,440.00                 | 25.72  | 19.76        | 45.48         |
| 6                    | 100        | 14.30                 | 1,430.00                 | 50.04  |              | 50.04         |
| 7                    | 100        | 12.25                 | 1,225.00                 |  |              |               |
| <b>Segment Total</b> | <b>800</b> | <b>12.73</b>          | <b>10,185.00</b>         | <b>604.05</b>                                | <b>63.49</b> | <b>667.54</b> |

### Spawning Habitat Patch count by Surface Area Size Class

| Spawning Gravel Size Class | Spawning Gravel Patch Surface Area Size Class (m2) |          |          |          | Total     |
|----------------------------|--|----------|----------|----------|-----------|
|                            | > 20   | 10-15    | 15-20    | 5-10     |           |
| small spawning gravel      | 8  | 2        | 1        | 3        | 14        |
| <b>Total</b>               | <b>8</b>   | <b>2</b> | <b>1</b> | <b>3</b> | <b>14</b> |

### Spawning Habitat Patch Information

Patch Number 1 Spawning Gravel Size Class small spawning gravel Surface Area (m2) 88.55  
Patch Size Class > 20

| SubPatch Number | SubPatch Surface Area (m2) | Downstream Reference Point | Side Channel |
|-----------------|----------------------------|----------------------------|--------------|
| 1               | 57.42                      | 0                          | n            |
| 2               | 18.02                      | 0                          | n            |
| 3               | 13.11                      | 0                          | n            |

Patch Number 10 Spawning Gravel Size Class small spawning gravel Surface Area (m2) 13.12  
Patch Size Class 10-15

| SubPatch Number | SubPatch Surface Area (m2) | Downstream Reference Point | Side Channel |
|-----------------|----------------------------|----------------------------|--------------|
| 0               | 13.12                      | 5                          | n            |



# **Appendix E**

**Standard Field and Vehicle Gear Checklist Copy Master**

**(Keep original copy master with manual)**



## Appendix E

### ✓ STANDARD FIELD GEAR

- Field clip board/form holder
- Survey Forms (on waterproof paper)
- Copy of survey methods
- Maps- topographic and road
- Pencils & erasers
- Permanent ink marker
- Calculator
- 150 mm ruler
- Pocket field notebook
  
- Survey Vest
- Compass
- Safety whistle
- Spring clips (2)
- Vinyl flagging
- Pocket knife/multi-purpose tool
  
- Backpack or canvas tote bag
- First aid kit
- Water bottle and/or filtration system
- Food/energy bars
- Rain gear
- Leather gloves
- Safety glasses
- Bug repellent
- Sun screen
- Small flashlight or headlamp
- Matches/fire starter
- Emergency blanket
- Snake bite kit (eastern Washington)

### ✓ STANDARD VEHICLE GEAR

- Waterproof plastic tote box
- Backup fiberglass tape
- Comprehensive first aid kit
- Rain tarp
- Rope (100 ft.)
- Extra water
- Extra food
- Extra dry clothes
- Extra batteries
- Spare tire/jack/tire iron
- Tire sealant/inflater
- Tow strap
- Come-along winch
- Fire shovel
- Fire extinguisher
- CB radio (to monitor logging activity)
- Cell phone/VHF radio
- Brush cutter
- Ax/bow saw/chain saw
- Tire chains

For remote work, extra survival & safety gear is recommended.

*This gear list is provided as a guideline for outfitting field crews and is not intended to cover all situations. Local conditions may require additional or different gear.*







