



TIMBER NOTICE OF SALE

SALE NAME: EXTRA CHRISTIE

AGREEMENT NO: 30-104583

AUCTION: August 30, 2023 starting at 10:00 a.m., COUNTY: Whatcom Northwest Region Office, Sedro Woolley, WA

SALE LOCATION: Sale located approximately 4 miles southeast of Acme, WA.

PRODUCTS SOLD AND SALE AREA: All timber bounded by white timber sale boundary tags, property lines and the CT-ML Road, except cedar salvage (cedar snags, preexisting dead and down cedar trees and cedar logs), trees marked with blue paint on the bole and root collar, and forest products tagged out by yellow leave tree area tags in Units #1 and #2.

All forest products above located on part(s) of Sections 29 all in Township 37 North, Range 5 East, W.M., containing 18 acres, more or less.

CERTIFICATION: This sale is certified under the Sustainable Forestry Initiative® program Standard (cert no: PwC-SFIFM-513)

ESTIMATED SALE VOLUMES AND QUALITY:

Table with columns: Species, Avg DBH, Ring Count, Total MBF, and MBF by Grade (1P, 2P, 3P, SM, 1S, 2S, 3S, 4S, UT). Rows include Douglas fir, Hemlock, Redcedar, Maple, Cottonwood, and Sale Total.

MINIMUM BID: \$287,000.00 BID METHOD: Sealed Bids

PERFORMANCE SECURITY: \$57,400.00 SALE TYPE: Lump Sum

EXPIRATION DATE: March 31, 2025 ALLOCATION: Export Restricted

BID DEPOSIT: \$28,700.00 or Bid Bond. Said deposit shall constitute an opening bid at the appraised price.

HARVEST METHOD: Cable or tethered equipment (See below for restrictions); Shovel or 6-wheeled-rubber-tired-skidders-with-over-the-tire-tracks-spanning-both-sets-of-rear-tires (See below for restrictions) on sustained slopes 40% or less; self-leveling equipment on sustained slopes 50% or less (See below for restrictions).

Purchaser must obtain prior written approval from the Contract Administrator for areas as to where to utilize tethered, self-leveling or rubber-tired skidder equipment prior to use. If ground disturbance is causing excessive damage, as determined by the Contract Administrator, the equipment shall no longer be authorized. Falling and Yarding will not be permitted from November 1 to March 31 unless authorized in writing by the Contract Administrator (THIS PERTAINS TO GROUND-BASED EQUIPMENT ONLY) to reduce soil damage and erosion.



## TIMBER NOTICE OF SALE

---

**ROADS:** 3.65 stations of required construction. 3.85 stations of optional construction. 182.65 stations of required prehaul maintenance. 3.85 stations of abandonment, if built.

Rock may be obtained from the following source(s) on State land at no charge to the Purchaser: Christie Pit at station 182+65 of the CT-ML Road.

An estimated total quantity of rock needed for this proposal: 10 cubic yards of riprap and 535 cubic yards of ballast rock.

Road work and the hauling of rock will not be permitted from November 1 to March 31 unless authorized in writing by the Contract Administrator to reduce soil damage and siltation. The hauling of forest products will not be permitted from November 1 to March 31 unless authorized in writing by the Contract Administrator to reduce soil damage and siltation.

### ACREAGE DETERMINATION

**CRUISE METHOD:** Acres determined by GPS traverse. Cruise was conducted via variable plot sample type. See Cruise Narrative for further details. Shapefiles of units are available upon request, and on the DNR website after the BNR meeting in which the sale is presented.

**FEES:** \$12,478.00 is due on day of sale. \$9.00 per MBF is due upon removal. These are in addition to the bid price.

**SPECIAL REMARKS:**

1. Trees marked with a pink "X" represent the last take tree along property line boundaries.
2. No operations are allowed to occur within the adjacent utility right-of-way. Also, no operations are allowed to restrict vehicular access to the adjacent utility right-of-way from the CT-ML Road.
3. Timber falling and hauling operations are not allowed prior to 7:00 a.m. daily.
4. HQ DF noted within the sale area.
5. Douglas-fir poles were noted within the sale area.

# TIMBER SALE MAP

**SALE NAME:** EXTRA CHRISTIE  
**AGREEMENT #:** None  
**TOWNSHIP(S):** T37R5E  
**TRUST(S):** State Forest Transfer (1)

**REGION:** Northwest Region  
**COUNTY(S):** Whatcom  
**ELEVATION RGE:** 320-520

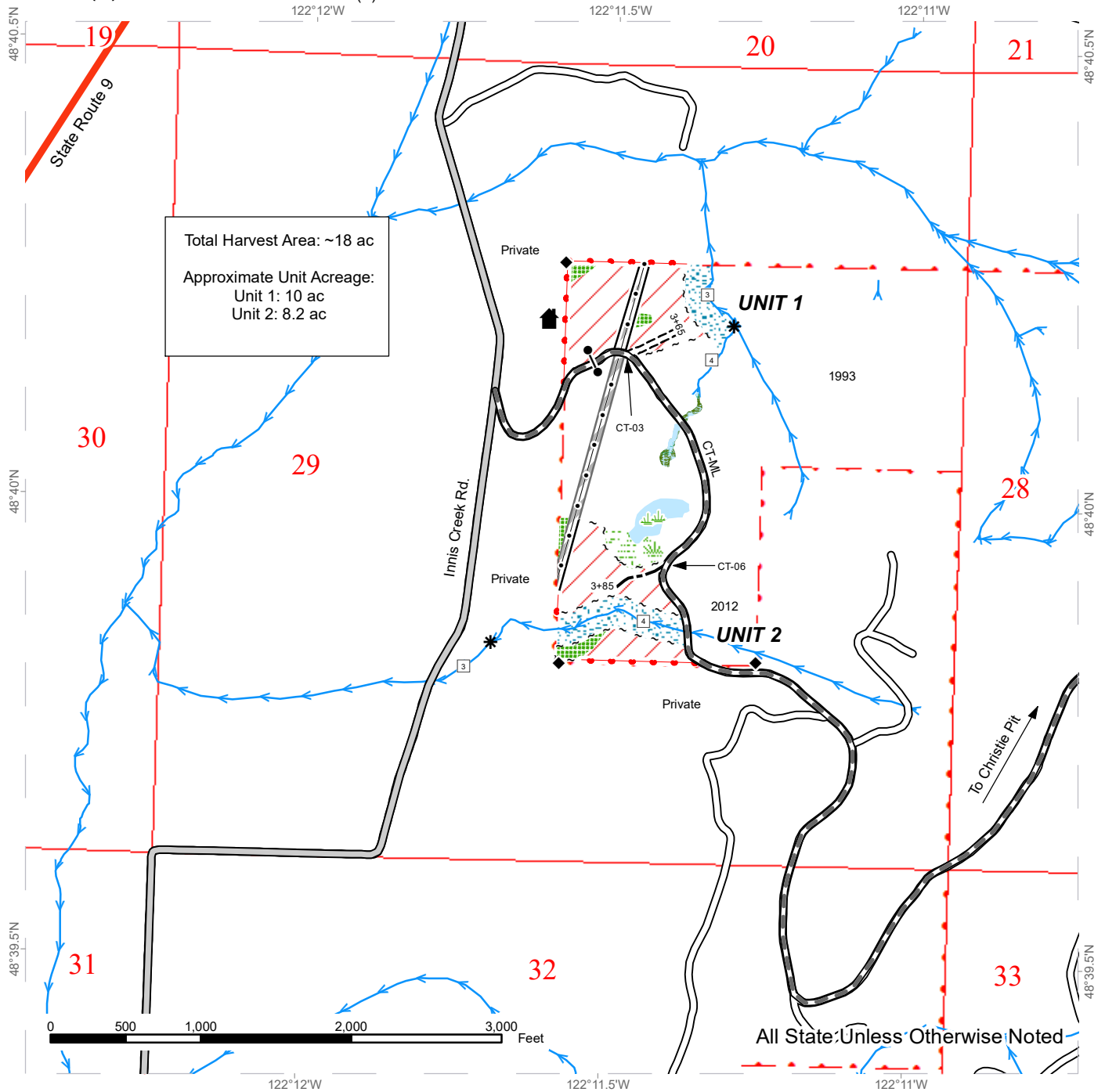

	Sale Area		Sale Boundary Tags		Streams
	Leave Tree Area		Property Line		Stream Type
	Wetlands - Non-forested		Timber Type Change		Stream Type Break
	Forested Wetland		County Road		Structure
	Wetland Mgt Zone		Existing Roads		Gate
	Riparian Mgt Zone		Required Pre-Haul Maintenance		Survey Monument
	Utility Right-of-Way		Required Construction		
	Pipeline		Optional Construction		









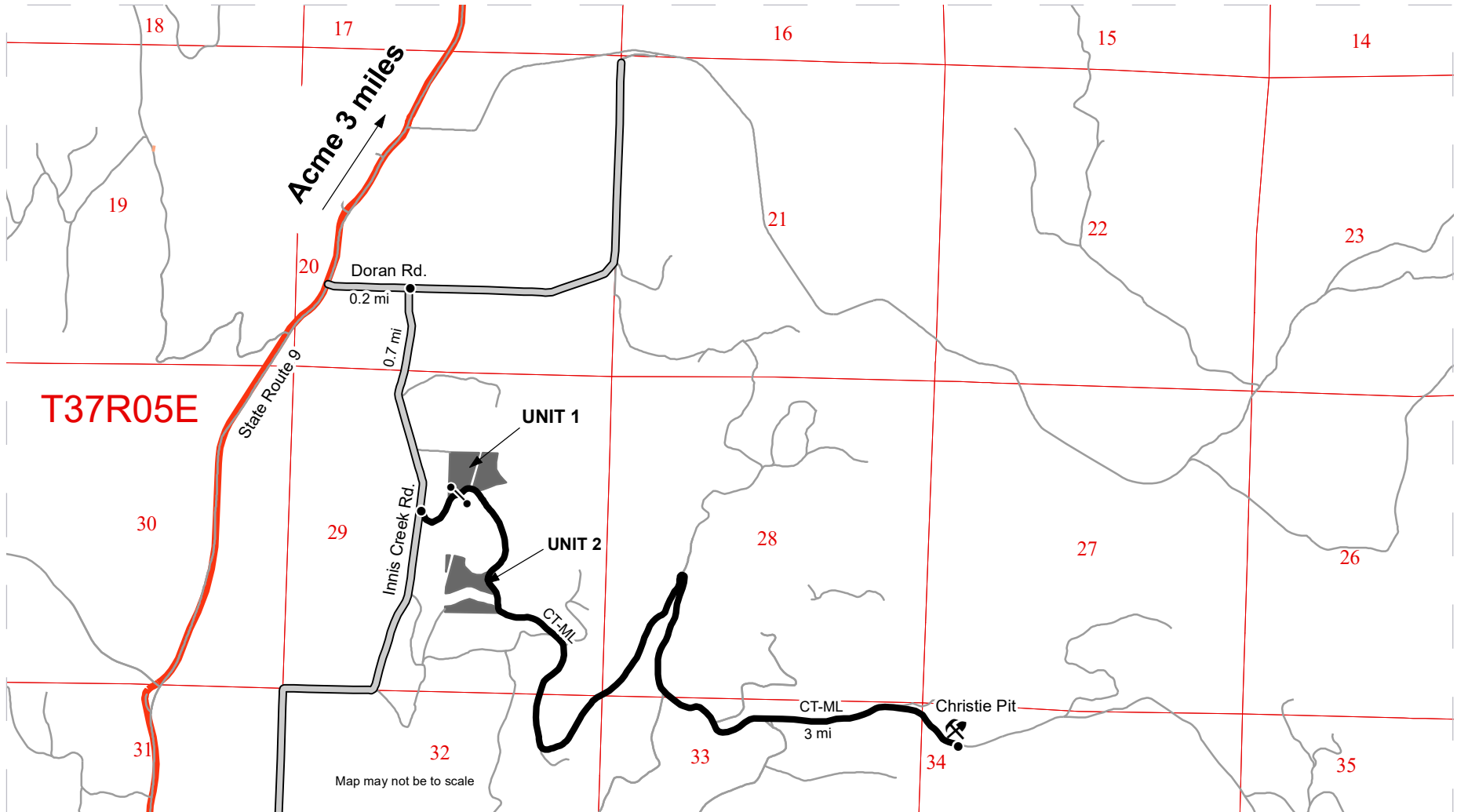

# DRIVING MAP

SALE NAME: EXTRA CHRISTIE  
AGREEMENT#: 30-104583  
TOWNSHIP(S): T37R5E  
TRUST(S): State Forest Transfer (1)

REGION: Northwest Region  
COUNTY(S): Whatcom  
ELEVATION RGE: 320-520



-  Timber Sale Unit
-  Haul Route
-  Other Road
-  County Road
-  Highway
-  Distance Indicator
-  Gate
-  Rock Pit

## DRIVING DIRECTIONS:

From Acme, drive south on State Route 9 for approximately 3 miles and turn left on to Doran Rd. Continue 0.2 miles, then turn right onto Innis Creek Rd. Continue 0.7 miles and turn left onto the CT-ML. Proceed 0.2 miles to Unit 1. Proceed another 0.3 miles on the CT-ML to access Unit 2. From there, proceed another 3 miles to access the Christie Pit.



**STATE OF WASHINGTON  
DEPARTMENT OF NATURAL RESOURCES**

**BILL OF SALE AND CONTRACT FOR  
FOREST PRODUCTS**

**Export Restricted Lump Sum AGREEMENT NO. 30-0104583**

**SALE NAME: EXTRA CHRISTIE**

**THE STATE OF WASHINGTON DEPARTMENT OF NATURAL  
RESOURCES, HEREINAFTER ACTING SOLELY, IN ITS PROPRIETARY  
CAPACITY, STATE, AND PURCHASER, AGREE AS FOLLOWS:**

Section G: General Terms

G-001 Definitions

The following definitions apply throughout this contract;

Bill of Sale and Contract for Forest Products: Contract between the Purchaser and the State, which sets forth the procedures and obligations of the Purchaser in exchange for the right to remove forest products from the sale area. The Bill of Sale and Contract for Forest Products may include a Road Plan for any road construction or reconstruction, where applicable.

Contract Administrator: Region Manager's designee responsible for assuring that the contractual obligations of the Purchaser are met.

Forest Product: Any material derived from the forest for commercial use.

Purchaser: The company or individual that has entered into a Bill of Sale and Contract for Forest Products with the State for the right to harvest and remove forest products from the timber sale area.

Road Construction: Includes building new and maintaining existing forest roads and associated work that may be optional or required as described in the Road Plan.

State: The Washington State Department of Natural Resources, landowner and seller of Forest Products from the timber sale area. The State is represented by the Region Manager as designated on the contract signature page. Contractual obligations to the State are enforced by the Region Manager or the designated Contract Administrator.

Subcontractor: Individual or company employed by the Purchaser to perform a portion or all of the services required by The Bill of Sale and Contract for Forest Products. The Purchaser is responsible for independently negotiating, procuring and paying for all subcontracted services rendered.

#### G-011 Right to Remove Forest Products and Contract Area

Purchaser was the successful bidder on August 30, 2023 and the sale was confirmed on \_\_\_\_\_. The State, as owner, agrees to sell to Purchaser, and Purchaser agrees to purchase as much of the following forest products as can be cut and removed during the term of this contract: All timber bounded by white timber sale boundary tags, property lines and the CT-ML Road, except cedar salvage (cedar snags, preexisting dead and down cedar trees and cedar logs), trees marked with blue paint on the bole and root collar, and forest products tagged out by yellow leave tree area tags in Units #1 and #2.

All forest products above located on approximately 18 acres on part(s) of Section 29 in Township 37 North, Range 5 East W.M. in Whatcom County(s) as designated on the sale area and as shown on the attached timber sale map.

All forest products described above from the bole of the tree that meet or exceed 2 inches diameter inside bark on the small end are eligible for removal. Above ground components of a tree that remain as by-products after the manufacture of logs, including but not limited to tree tops, branches, limbs, needles, leaves, stumps, are not eligible for removal under the terms of this contract.

Forest products purchased under a contract that is designated as export restricted shall not be exported until processed. Forest products purchased under a contract that is designated as exportable may be exported prior to processing.

#### G-020 Inspection By Purchaser

Purchaser hereby warrants to the State that they have had an opportunity to fully inspect the sale area and the forest products being sold. Purchaser further warrants to the State that they enter this contract based solely upon their own judgment of the value of the forest products, formed after their own examination and inspection of both the timber sale area and the forest products being sold. Purchaser also warrants to the State that they enter this contract without any reliance upon the volume estimates, acreage estimates, appraisals, pre-bid documentation, or any other representations by the State Department of Natural Resources.

G-031 Contract Term

Purchaser shall complete all work required by this contract prior to March 31, 2025.

G-040 Contract Term Adjustment - No Payment

Purchaser may request an adjustment in the contract term. A claim must be submitted in writing and received by the State within 30 days after the start of interruption or delay. The claim must also indicate the actual or anticipated length of interruption or delay. The State may grant an adjustment without charge only if the cause for contract term adjustment is beyond Purchaser's control. The cause must be one of the following and the adjustment may be granted only if operations or planned operations under this contract are actually interrupted or delayed:

- a. Road and bridge failures which deny access.
- b. Access road closures imposed by road owner.
- c. Excessive suspensions as provided in clause G-220.
- d. Regulatory actions not arising from Purchaser's failure to comply with this contract which will prevent timber harvest for a period less than 6 months.

G-051 Contract Term Extension - Payment

Extensions of this contract term may be granted only if, in the judgment of the State, Purchaser is acting in good faith and is endeavoring to remove the forest products conveyed. The term of this contract may be extended for a reasonable time by the State if all of the following conditions are satisfied:

- a. A written request for extension of the contract term must be received prior to the expiration date of the contract.
- b. Completion of all required roads and compliance with all contract and regulatory requirements.
- c. For the first extension, not to exceed 1 year, payment of at least 25 percent of the total contract price.

For the second extension, not to exceed 1 year, payment of at least 90 percent of the total contract price.

The payments shall not include the initial deposit which shall be held according to the provisions of RCW 79.15.100.

- d. Payment of an amount based on 12 percent interest per annum on the unpaid portion of the total contract price.

All payments, except the initial deposit, will be deducted from the total contract price to determine the unpaid portion of the contract.

- e. Payment of \$1,226.00 per acre per annum for the acres on which an operating release has not been issued in the sale area.
- f. In no event will the extension charge be less than \$200.00.
- g. Extension payments are non-refundable.

G-053 Surveys - Sensitive, Threatened, Endangered Species

Whenever the State determines that a survey for sensitive, threatened, or endangered species is prudent, or when Purchaser determines a survey is prudent and the State agrees, Purchaser shall perform such surveys at Purchaser's expense and to the standards required by the State. The survey information shall be supplied to the State.

G-060 Exclusion of Warranties

The PARTIES AGREE that the IMPLIED WARRANTIES OF MERCHANTABILITY AND FITNESS FOR A PARTICULAR PURPOSE and ALL OTHER WARRANTIES EXPRESSED OR IMPLIED ARE EXCLUDED from this transaction and shall not apply to the goods sold. For example, THE FOLLOWING SPECIFIC MATTERS ARE NOT WARRANTED, and are EXCLUDED from this transaction:

- a. The MERCHANTABILITY of the forest products. The use of the term "merchantable" in any document is not intended to vary the foregoing.
- b. The CONDITION of the forest products. The forest products will be conveyed "AS IS."
- c. The ACREAGE contained within any sale area. Any acreage descriptions appearing in the timber notice of sale, timber sale contract, or other documents are estimates only, provided solely for administrative and identification purposes.
- d. The VOLUME, QUALITY, OR GRADE of the forest products. The State neither warrants nor limits the amount of timber to be harvested. The descriptions of the forest products to be conveyed are estimates only, made solely for administrative and identification purposes.
- e. The CORRECTNESS OF ANY SOIL OR SURFACE CONDITIONS, PRE-SALE CONSTRUCTION APPRAISALS, INVESTIGATIONS, AND ALL OTHER PRE-BID DOCUMENTS PREPARED BY OR FOR THE STATE. These documents have been prepared for the State's appraisal purposes only.
- f. THAT THE SALE AREA IS FREE FROM THREATENED OR ENDANGERED SPECIES or their habitat. The State is not responsible for any interference with forestry operations that result from the presence of any



threatened or endangered species, or the presence of their habitat, within the sale area.

- g. THAT THE FORESTRY OPERATIONS to be performed under this contract WILL BE FREE FROM REGULATORY ACTIONS by governmental agencies. The State is not responsible for actions to enforce regulatory laws, such as the Washington Forest Practices Act (chapter 76.09 RCW), taken by the Department of Natural Resources or any other agency that may affect the operability of this timber sale.
- h. Items contained in any other documents prepared for or by the State.

G-061 Inadvertent Discovery of Cultural Resources

Purchaser acknowledges that cultural resources as defined in WAC 222-16-010 may exist within the timber sale area and that the existence and location of such resources may be unknown at the time this contract is executed. Purchaser has a duty to exercise due care in its operations and in the event any human skeletal remains are discovered by the Purchaser or the State during the course of operations Purchaser shall immediately halt operations and notify local law enforcement in the most expeditious manner possible then notifying the Contract Administrator. In the event cultural resources are discovered by the Purchaser or the State during the course of operations Purchaser shall immediately halt operations and notify the Contract Administrator. Any potential resources shall not be removed or disturbed. Purchaser shall resume operations as directed in writing by the Contract Administrator.

G-062 Habitat Conservation Plan

The State has entered into a Habitat Conservation Plan (HCP) with the U.S. Fish and Wildlife Service and the National Marine Fisheries Service (the Services) to address state trust land management issues relating to compliance with the Federal Endangered Species Act. The activities to be carried out under this contract are located within the State's HCP area and are subject to the terms and conditions of the HCP, and the Services' Incidental Take Permit Nos. TE812521-1 and 1168 (collectively referred to as ITP), or as amended hereafter by the Services. The ITP authorizes the incidental take of certain federally listed threatened and endangered species, as specified in the ITP conditions. All HCP materials, including the ITP, are available for review at the State's Regional Offices and the administrative headquarters in Olympia, Washington.

By signing this contract, Purchaser agrees to comply with the terms and conditions of the ITP, and the HCP, which shall become terms of this contract. The State agrees to authorize the lawful activities of the Purchaser carried out pursuant to this contract, PROVIDED the Purchaser remains in compliance with the terms and conditions of both the HCP and ITP. The requirements set forth in this contract are intended to comply with the terms and conditions of the HCP and ITP. Accordingly, non-compliance with the terms and conditions of the HCP and ITP will render the authorization provided in this paragraph void, be deemed a breach of the contract and may subject Purchaser to liability for violation of the Endangered Species Act.

Any modifications to the contract shall be proposed in writing by Purchaser, shall continue to meet the terms and conditions of the HCP and ITP, and shall require the prior written approval of the Region Manager before taking effect.

G-063 Incidental Take Permit Notification Requirements

- a. Purchaser shall immediately notify the Contract Administrator of new locations of permit species covered by the Incidental Take Permits (ITP) that are discovered within the area covered by the State's Habitat Conservation Plan (HCP), including, but not limited to: locations of occupied murrelet habitat; spotted owl nest sites; wolves; grizzly bears; nests, communal roosts, or feeding concentrations of bald eagles; peregrine falcon nests; Columbian white-tailed deer; Aleutian Canada geese; Oregon silverspot butterflies; and additional stream reaches found to contain bull trout. Purchaser is required to notify the Contract Administrator upon discovery of any fish species found in streams or bodies of water classified as non-fish bearing. In all circumstances, notification must occur within a 24 hour time period.
- b. Upon locating any live, dead, injured, or sick specimens of any permit species covered by the ITP, Purchaser shall immediately notify the Contract Administrator. Purchaser shall notify the Contract Administrator if there is any doubt as to the identification of a discovered permit species. Purchaser may be required to take certain actions to help the Contract Administrator safeguard the well-being of any live, injured or sick specimens of any permit species discovered, until the proper disposition of such specimens can be determined by the Contract Administrator. Any such requirements will be explained to Purchaser by the Contract Administrator during the Pre-Work Conference. In all circumstances, notification must occur within a 24 hour time period.
- c. Purchaser shall refer to a specific ITP number, ITP TE812521-1 or ITP 1168 (copies which are located in the region office) in all correspondence and reports concerning permit activities.
- d. Provisions and requirements of the ITP shall be clearly presented and explained to Purchaser by Contract Administrator during the Pre-Work Conference as per contract clause G-330. All applicable provisions of the ITP and this schedule must be presented and clearly explained by Purchaser to all authorized officers, employees, contractors, or agents of Purchaser conducting authorized activities in the timber sale area. Any questions Purchaser may have about the ITP should be directed to the Contract Administrator.

G-064 Permits

Purchaser is responsible for obtaining any permits not already obtained by the State that relate to Purchaser's operation. Forest Practice Application / Hydraulic Project Approval permits obtained by the State shall be transferred to Purchaser. Purchaser is responsible for all permits, amendments and renewals.

## G-065 Regulatory Disclaimer

The State disclaims any responsibility for, or liability relating to, regulatory actions by any government agency, including actions pursuant to the Forest Practices Act, Ch. 76.09 RCW that may affect the operability of the timber sale.

## G-066 Governmental Regulatory Actions

## a. Risk

Purchaser shall be responsible for any increased operational costs arising from any applicable foreign or domestic governmental regulation or order that does not cause contract performance to become commercially impracticable or that does not substantially frustrate the purpose of the contract. If impracticability or frustration results from Purchaser's failure to comply with this contract, Purchaser shall remain responsible for payment of the total contract price notwithstanding the impracticability or frustration.

## b. Sale Area

When portions of the sale area become subject to a foreign or domestic governmental regulation or order that will likely prevent timber harvest for a period that will exceed the expiration date of this contract, and Purchaser has complied with this contract, the following shall apply:

i. RCW 79.15.140 shall govern all adjustments to the contract area.

## c. Adjustment of Price

The State shall adjust the total contract price by subtracting from the total contract price an amount determined in the following manner: The State shall cause the timber sale area subject to governmental regulation or order to be measured. The State shall calculate the percentage of the total sale area subject to the governmental regulation or order. The State shall reduce the total contract price by that calculated percentage. However, variations in species, value, costs, or other items pertaining to the affected sale area will be analyzed and included in the adjustment if deemed appropriate by the State. The State will further reduce the total contract price by the reasonable cost of unamortized roads Purchaser constructed but was unable to fully use for removing timber. A reduction in total contract price terminates all of the Purchaser's rights to purchase and remove the timber and all other interest in the affected sale area.

## G-070 Limitation on Damage

In the event of a breach of any provision of this contract by the State, the exclusive remedy available to Purchaser will be limited to a return of the initial deposit, unapplied payments, and credit for unamortized improvements made by Purchaser.

The State shall not be liable for any damages, whether direct, incidental or consequential.

G-080 Scope of State Advice

No advice by any agent, employee, or representative of the State regarding the method or manner of performing shall constitute a representation or warranty that said method, manner or result thereof will conform to the contract or be suitable for Purchaser's purposes under the contract. Purchaser's reliance on any State advice regarding the method or manner of performance shall not relieve Purchaser of any risk or obligation under the contract. Purchaser retains the final responsibility for its operations under this contract and State shall not be liable for any injuries resulting from Purchaser's reliance on any State advice regarding the method or manner of performance.

G-091 Sale Area Adjustment

The Parties may agree to adjustments in the sale area boundary. The cumulative changes to the sale area during the term of the contract shall not exceed more than four percent of the original sale area. If the sale area is increased, the added forest products become a part of this contract. The State shall determine the volume added and shall calculate the increase to the total contract price using the rates set forth in clause G-101, G-102, or G-103. If the sale area is reduced, the State shall determine the volume to be reduced. The State shall calculate the reduction to the total contract price using the rates set forth in clause G-101, G-102, or G-103.

G-101 Forest Products Not Designated

Any forest products not designated for removal, which must be removed in the course of operations authorized by the State, shall be approved and designated by the Contract Administrator. Added forest products become a part of this contract and the Scribner log scale volume, as defined by the Northwest Log Rules Advisory Group, shall be determined by the Contract Administrator. Added forest products shall be paid for at the following contract payment rates per Mbf Scribner log scale.

Contract Item	Appraised Price	Overbid Factor	Price	Fees	Contract Payment Rate
Cottonwood	\$100.63	0	\$0.00	\$9.00	\$9.00
Douglas fir	\$395.89	0	\$0.00	\$9.00	\$9.00
Hemlock	\$273.48	0	\$0.00	\$9.00	\$9.00
Maple	\$210.74	0	\$0.00	\$9.00	\$9.00
Redcedar	\$685.99	0	\$0.00	\$9.00	\$9.00
Other	\$371.82	0	\$0.00	\$9.00	\$9.00

G-106 Adding Naturally Damaged Forest Products

Any forest products not designated for removal that are seriously damaged by disease, insects or wind, or that may contribute seriously to the spread of insect or disease damage may be added to this sale by the State's Contract Administrator. Additions must be in unlogged areas of the sale and added volume shall not exceed an amount equal to 10 percent of the original advertised volume. Added forest products become a

part of this contract and shall be paid for at the rate set forth in clause G-101, G-102 or G-103.

G-111 Title and Risk of Loss

Title to the forest products under this contract passes to the Purchaser after they are removed from the sale area, if adequate advance payment or payment security has been provided to the State under this contract. Purchaser bears all risk of loss of, or damage to, and has an insurable interest in, the forest products described in this contract from the time the sale is confirmed under RCW 79.15.120. Breach of this contract shall have no effect on this provision.

G-116 Sustainable Forestry Initiative® (SFI) Certification

Forest products purchased under this contract are certified as being in conformance with the Sustainable Forestry Initiative program Standard under certificate number: PwC-SFIFM-513.

Purchaser shall have at least one person regularly on-site during active operations that have completed training according to the requirements outlined within the SFI® program Standard. Purchaser shall designate in writing the name(s) of the individual(s) who will be on-site and provide proof of their successful completion of an approved training program prior to active operations.

G-120 Responsibility for Work

All work, equipment, and materials necessary to perform this contract shall be the responsibility of Purchaser. Any damage to improvements, except as provided in clause G-121 or unless the State issues an operating release pursuant to clause G-280, shall be repaired promptly to the satisfaction of the State and at Purchaser's expense.

G-121 Exceptions

Exceptions to Purchaser's responsibility in clause G-120 shall be limited exclusively to the following. These exceptions shall not apply where road damage occurs due to Purchaser's failure to take reasonable precautions or to exercise sound forest engineering and construction practices.

The State will bear the cost to repair damages caused by a third party. In all other cases, the Purchaser shall bear responsibility for the costs as described below.

Road is defined as the road bed, including but not limited to its component parts, such as cut and fill slopes, subgrade, ditches, culverts, bridges, and cattle guards.

For the purposes of this clause, damage will be identified by the State and is defined as:

1. Failure of (a) required improvements or roads designated in clause C-050, or (b) required or optional construction completed to the point that authorization to haul has been issued;

2. Caused by a single event from forces beyond the control of Purchaser, its employees, agents, or invitees, including independent contractors; and
3. Includes, but is not limited to natural disasters such as earthquakes, volcanic eruptions, landslides, and floods.

The repair work identified by the State shall be promptly completed by Purchaser at an agreed price. The State may elect to accomplish repairs by means of State-provided resources.

For each event, Purchaser shall be solely responsible for the initial \$5,000 in repairs. For repairs in excess of \$5,000, the parties shall share equally the portion of costs between \$5,000 and \$15,000. The State shall be solely responsible for the portion of the cost of repairs that exceed \$15,000.

Nothing contained in clauses G-120 and G-121 shall be construed as relieving Purchaser of responsibility for, or damage resulting from, Purchaser's operations or negligence, nor shall Purchaser be relieved from full responsibility for making good any defective work or materials. Authorization to haul does not warrant that Purchaser built roads are free from material defect and the State may require additional work, at Purchasers expense regardless of cost, to remedy deficiencies at any time.

#### G-140 Indemnity

To the fullest extent permitted by law, Purchaser shall indemnify, defend and hold harmless State, agencies of State and all officials, agents and employees of State, from and against all claims arising out of or resulting from the performance of the contract. "Claim" as used in this contract means any financial loss, claim, suit, action, damage, or expense, including but not limited to attorneys' fees, attributable for bodily injury, sickness, disease or death, or injury to or destruction of tangible property including loss of use resulting therefrom. Purchasers' obligations to indemnify, defend, and hold harmless includes any claim by Purchasers' agents, employees, representatives, or any subcontractor or its employees. Purchaser expressly agrees to indemnify, defend, and hold harmless State for any claim arising out of or incident to Purchasers' or any subcontractors' performance or failure to perform the contract. Purchasers' obligation to indemnify, defend, and hold harmless State shall not be eliminated or reduced by any actual or alleged concurrent negligence of State or its agents, agencies, employees and officials. Purchaser waives its immunity under Title 51 RCW to the extent it is required to indemnify, defend and hold harmless State and its agencies, officials, agents or employees.

#### G-150 Insurance

Purchaser shall, at its cost and expense, buy and maintain insurance of the types and amounts listed below. Failure to buy and maintain the required insurance may result in a breach and/or termination of the contract at State's option. State may suspend Purchaser operations until required insurance has been secured.

All insurance and surety bonds should be issued by companies admitted to do business within the State of Washington and have a rating of A-, Class VII or better in the most recently published edition of Best's Reports. If an insurer is not admitted, all insurance policies and procedures for issuing the insurance policies must comply with Chapter 48.15 RCW and 284-15 WAC.

The State of Washington, Department of Natural Resources region office of sale origin shall be provided written notice before cancellation or non-renewal of any insurance referred to therein, in accord with the following specifications:

1. Insurers subject to Chapter 48.18 RCW (admitted and regulated by the Insurance Commissioner): The insurer shall give the State 45 days advance notice of cancellation or non-renewal. If cancellation is due to non-payment of premium, the State shall be given 10 days advance notice of cancellation.
2. Insurers subject to Chapter 48.15 RCW (surplus lines): The State shall be given 20 days advance notice of cancellation. If cancellation is due to non-payment of premium, the State shall be given 10 days advance notice of cancellation.

Before starting work, Purchaser shall furnish State of Washington, Department of Natural Resources with a certificate(s) of insurance, executed by a duly authorized representative of each insurer, showing compliance with the insurance requirements specified in the contract. Insurance coverage shall be obtained by the Purchaser prior to operations commencing and continually maintained in full force until all contract obligations have been satisfied or an operating release has been signed by the State.

Purchaser shall include all subcontractors as insured under all required insurance policies, or shall furnish separate certificates of insurance and endorsements for each subcontractor. Subcontractor(s) must comply fully with all insurance requirements stated herein. Failure of subcontractor(s) to comply with insurance requirements does not limit Purchaser's liability or responsibility.

The State of Washington, Department of Natural Resources, its elected and appointed officials, agents and employees shall be named as an additional insured via endorsement on all general liability, excess, umbrella, and property insurance policies.

All insurance provided in compliance with this contract shall be primary as to any other insurance or self-insurance programs afforded to or maintained by State. Purchaser waives all rights against State for recovery of damages to the extent these damages are covered by general liability or umbrella insurance maintained pursuant to this contract.

By requiring insurance herein, State does not represent that coverage and limits will be adequate to protect Purchaser and such coverage and limits shall not limit Purchaser's liability under the indemnities and reimbursements granted to State in this contract.

The limits of insurance, which may be increased as deemed necessary by State of Washington, Department of Natural Resources, shall not be less than as follows:

Commercial General Liability (CGL) Insurance. Purchaser shall maintain general liability (CGL) insurance, and, if necessary, commercial umbrella insurance with a limit of not less than \$1,000,000.00 per each occurrence. If such CGL insurance contains aggregate limits, the General Aggregate limit shall be at least twice the "each occurrence" limit. CGL insurance shall have products-completed operations aggregate limit of at least two times the "each occurrence" limit. CGL coverage shall include a Logging and Lumbering Endorsement (i.e. Logger's Broad-Form) to cover the events that include, but are not limited to, fire suppression expenses, accidental timber trespasses, and wildfire property damage with limits of not less than \$2,000,000.00 each occurrence.

CGL insurance shall be written on Insurance Services Office (ISO) occurrence form CG 00 01 (or a substitute form providing equivalent coverage). All insurance shall cover liability arising out of premises, operations, independent contractors, products completed operations, personal injury and advertising injury, and liability assumed under an insured contract (including the tort liability of another party assumed in a business contract), and contain separation of insured (cross liability) condition.

Employer's Liability "Stop Gap" Insurance. Purchaser shall buy employers liability insurance, and, if necessary, commercial umbrella liability insurance with limits not less than \$1,000,000.00 each accident for bodily injury by accident or \$1,000,000.00 each employee for bodily injury by disease.

Workers' Compensation Coverage. Purchaser shall comply with all State of Washington workers' compensation statutes and regulations. Workers' compensation coverage shall be provided for all employees of Purchaser and employees of any subcontractor or sub-subcontractor. Coverage shall include bodily injury (including death) by accident or disease, which exists out of or in connection with the performance of this contract. Except as prohibited by law, Purchaser waives all rights of subrogation against State for recovery of damages to the extent they are covered by workers' compensation, employer's liability, commercial general liability, or commercial umbrella liability insurance.

If Purchaser, subcontractor or sub-subcontractor fails to comply with all State of Washington workers' compensation statutes and regulations and State incurs fines or is required by law to provide benefits to or obtain coverage for such employees, Purchaser shall indemnify State. Indemnity shall include all fines, payment of benefits to Purchaser or subcontractor employees, or their heirs or legal representatives, and the cost of effecting coverage on behalf of such employees.

Business Auto Policy (BAP). Purchaser shall maintain business auto liability and, if necessary, commercial umbrella liability insurance with a limit not less than \$1,000,000.00 per accident. Such insurance shall cover liability arising out of "Any



Auto". Business auto coverage shall be written on ISO form CA 00 01, or substitute liability form providing equivalent coverage. If necessary the policy shall be endorsed to provide contractual liability coverage and cover a "covered pollution cost or expense" as provided in the 1990 or later editions of CA 00 01. Purchaser waives all rights against State for the recovery of damages to the extent they are covered by business auto liability or commercial umbrella liability insurance.

G-160 Agents

The State's rights and duties will be exercised by the Region Manager at Sedro Woolley, Washington. The Region Manager will notify Purchaser in writing who is responsible for administering the contract. The Region Manager has sole authority to waive, modify, or amend the terms of this contract in the manner prescribed in clause G-180. No agent, employee, or representative of the State has any authority to bind the State to any affirmation, representation, or warranty concerning the forest products conveyed beyond the terms of this contract.

Purchaser is required to have a person on site during all operations who is authorized to receive instructions and notices from the State. Purchaser shall inform the State in writing who is authorized to receive instructions and notices from the State, and any limits to this person's authority.

G-170 Assignment and Delegation

No rights or interest in this contract shall be assigned by Purchaser without prior written permission of the State. Any attempted assignment shall be void and ineffective for all purposes unless made in conformity with this paragraph. Purchaser may perform any duty through a delegate, but Purchaser is not thereby relieved of any duty to perform or any liability. Any assignee or delegate shall be bound by the terms of the contract in the same manner as Purchaser.

G-180 Modifications

Waivers, modifications, or amendments of the terms of this contract must be in writing signed by Purchaser and the State.

G-190 Contract Complete

This contract is the final expression of the Parties' agreement. There are no understandings, agreements, or representations, expressed or implied, which are not specified in this contract.

G-200 Notice

Notices required to be given under the following clauses shall be in writing and shall be delivered to Purchaser's authorized agent or sent by certified mail to Purchaser's address of record:

G-210 Violation of Contract

G-220 State Suspends Operations

All other notices required to be given under this contract shall be in writing and delivered to the authorized agent or mailed to the Party's post office address. Purchaser agrees to notify the State of any change of address.

#### G-210 Violation of Contract

- a. If Purchaser violates any provision of this contract, the Contract Administrator, by written notice, may suspend those operations in violation. If the violation is capable of being remedied, Purchaser has 30 days after receipt of a suspension notice to remedy the violation. If the violation cannot be remedied (such as a violation of WAC 240-15-015) or Purchaser fails to remedy the violation within 30 days after receipt of a suspension notice, the State may terminate the rights of Purchaser under this contract and collect damages.
- b. If the contract expires pursuant to clause G-030 or G-031 without Purchaser having performed all its duties under this contract, Purchaser's right to operate is terminated and Purchaser shall not have the right to remedy the breach. This provision shall not relieve Purchaser of any payment obligations.
- c. The State has the right to remedy the breach in the absence of any indicated attempt by Purchaser or if Purchaser is unable, as determined by the State, to remedy the breach. Any expense incurred by the State shall be charged to Purchaser and shall be paid within 30 days of receipt of billing.
- d. If Purchaser's violation is a result of a failure to make a payment when due, in addition to a. and b. above, interest shall accrue on the unpaid balance at 12 percent per annum, beginning the date payment was due.

#### G-220 State Suspends Operations

The Contract Administrator may suspend any operation of Purchaser under this contract when the State is suffering, or there is a reasonable expectation the State will suffer environmental, monetary, or other damage if the operation is allowed to continue.

Purchaser shall be in breach of this contract if the operation continues after the suspension notice or if the operation resumes without prior approval and notice from the Contract Administrator.

Purchaser may request a modification of a suspension within 30 days of the start of suspension through the dispute resolution process in clause G-240. If this process results in a finding that the suspension exceeded the time reasonably necessary to stop or prevent damage to the State, Purchaser is entitled to request a contract term adjustment under clause G-040.

If it reasonably appears that the damage that the State is suffering, or can reasonably be expected to suffer if the operation is allowed to continue, will prevent harvest for a period that will exceed 6 months, and Purchaser has complied with this contract, the

provisions of clause G-066 shall govern just as if the harvest was prevented by an applicable foreign or domestic governmental regulation or order.

G-230 Unauthorized Activity

Any cutting, removal, or damage of forest products by Purchaser, its employees, agents, or invitees, including independent contractors, in a manner inconsistent with the terms of this contract or State law, is unauthorized. Such activity may subject Purchaser to liability for triple the value of said forest products under RCW 79.02.320 or RCW 79.02.300 and may result in prosecution under RCW 79.02.330 or other applicable statutes.

G-240 Dispute Resolution

The following procedures apply in the event of a dispute regarding interpretation or administration of this contract and the parties agree that these procedures must be followed before a lawsuit can be initiated.

- a. In the event of a dispute, Purchaser must make a written request to the Region Manager for resolution prior to seeking other relief.
- b. The Region Manager will issue a written decision on Purchaser's request within ten business days.
- c. Within ten business days of receipt of the Region Manager's decision, Purchaser may make a written request for resolution to the Deputy Supervisor - Uplands of the Department of Natural Resources.
- d. Unless otherwise agreed, a conference will be held by the Deputy Supervisor - Uplands within 30 calendar days of the receipt of Purchaser's request for review of the Region Manager's written decision. Purchaser and the Region Manager will have an opportunity to present their positions. The Deputy Supervisor - Uplands will issue a decision within a reasonable time of being presented with both Parties' positions.

G-250 Compliance with All Laws

Purchaser shall comply with all applicable statutes, regulations and laws, including, but not limited to; chapter 27.53 RCW, chapter 68.50 RCW, WAC 240-15 and WAC 296-54. Failure to comply may result in forfeiture of this contract.

G-260 Venue

This contract shall be governed by the laws of the State of Washington. In the event of a lawsuit involving this contract, venue shall be proper only in Thurston County Superior Court.

G-270 Equipment Left on State Land

All equipment owned or in the possession of Purchaser, its employees, agents, or invitees, including independent contractors, shall be removed from the sale area and other State land by the termination date of this contract. Equipment remaining

unclaimed on State land 60 days after the expiration of the contract period is subject to disposition as provided by law. Purchaser shall pay to the State all costs of moving, storing, and disposing of such equipment. The State shall not be responsible for any damages to or loss of the equipment or damage caused by the moving, storing or disposal of the equipment.

G-280 Operating Release

An operating release is a written document, signed by the State and Purchaser, indicating that Purchaser has been relieved of certain rights or responsibilities with regard to the entire or a portion of the timber sales contract. Purchaser and State may agree to an operating release for this sale, or portion of this sale, prior to the contract expiration, when all contract requirements pertaining to the release area have been satisfactorily completed. Upon issuance of a release, Purchaser's right to cut and remove forest products on the released area will terminate.

G-310 Road Use Authorization

Purchaser is authorized to use the following State roads and roads for which the State has acquired easements and road use permits; CT-ML, CT-03 and CT-06. The State may authorize in writing the use of other roads subject to fees, restrictions, and prior rights.

G-330 Pre-work Conference

Purchaser shall arrange with the Contract Administrator to review this contract and to examine the sale area before beginning any operations. A plan of operations shall be developed and agreed upon by the Contract Administrator and Purchaser before beginning any operations. To the extent that the plan of operations is inconsistent with the contract, the terms of the contract shall prevail. State's acceptance and approval of Purchaser's plan of operations shall not be construed as any statement or warranty that the plan of operations is adequate for Purchaser's purposes or complies with applicable laws.

G-340 Preservation of Markers

Any legal land subdivision survey corners and witness objects are to be preserved. If such are destroyed or disturbed, the Purchaser shall, at the Purchaser's own expense, re-establish them through a licensed land surveyor in accordance with U.S. General Land Office standards. Corners and/or witness objects that must be disturbed or destroyed in the process of road construction or logging shall be adequately referenced and/or replaced in accordance with RCW 58.24.040(8). Such references must be approved by the Contract Administrator prior to removal of said corners and/or witness objects.

G-360 Road Use Reservation

The State shall have the right to use, without charge, all existing roads and any road constructed or reconstructed on State lands by Purchaser under this contract. The State may extend such rights to others. If the State grants such rights to others, the State shall require performance or payment, as directed by the State, for their proportionate share of maintenance based on their use.

G-370 Blocking Roads

Purchaser shall not block the CT-ML Road, unless authority is granted in writing by the Contract Administrator.

G-380 Road Easement and Road Use Permit Requirements

Purchaser agrees to comply with the terms and conditions of the attached:

Easements:

Robert W. DeHoff and Dorothy M. DeHoff, dated February 8, 1967; and US Federal Housing Commissioner, dated August 29, 1967; #55-000247.

Scott Paper Company; #55-000834; dated February 7, 1973.

A.M. Simmers and Sally Simmers; #55-001456; dated February 23, 1978.

Georgia Pacific Corporation, #55-002385, dated December 4, 1990.

Between John Hancock Mutual Life Insurance Company and Rayonier; #55-076122; dated July 24, 1997.

G-430 Open Fires

Purchaser shall not set, or allow to be set by Purchaser's employees, agents, invitees and independent contractors, any open fire at any time of the year without first obtaining permission, in writing, from the Contract Administrator.

G-450 Encumbrances

This contract and Purchaser's activities are subject to the following:

DATA MISSING

Section P: Payments and Securities

P-011 Initial Deposit

Purchaser paid DATA MISSING initial deposit, which will be maintained pursuant to RCW 79.15.100(3). If the operating authority on this contract expires without Purchaser's payment of the full amount specified in Clause P-020, the initial deposit will be immediately forfeited to the State, and will be offset against Purchaser's remaining balance due. Any excess initial deposit funds not needed to ensure full payment of the contract price, or not needed to complete any remaining obligations of the Purchaser existing after contract expiration, will be refunded to the Purchaser.

P-020 Payment for Forest Products

Purchaser agrees to pay the total, lump sum contract price of \$19,084.00. The total contract price consists of a \$0.00 contract bid price plus \$19,084.00 in fees. Fees collected shall be retained by the state unless the contract is adjusted via the G-066

clause. Purchaser shall be liable for the entire purchase price, and will not be entitled to any refunds or offsets unless expressly stated in this contract.

THE PURCHASE PRICE SHALL NOT BE AFFECTED BY ANY FACTORS, INCLUDING: the amount of forest products actually present within the contract area, the actual acreage covered by the contract area, the amount or volume of forest products actually cut or removed by purchaser, whether it becomes physically impossible or uneconomic to remove the forest products, and whether the subject forest products have been lost or damaged by fire or any other cause. The only situations Purchaser may not be liable for the full purchase price are governed by clause G-066, concerning governmental regulatory actions taken during the term of the contract.

P-045 Guarantee of Payment

Purchaser will pay for forest products prior to cutting or will guarantee payment by posting an approved payment security. The amount of cash or payment security shall be determined by the State and shall equal or exceed the value of the cutting proposed by Purchaser.

P-050 Billing Procedure

The State will compute and forward to Purchaser statements of charges provided for in the contract. Purchaser shall deliver payment to the State on or before the date shown on the billing statement.

P-080 Payment Account Refund

Advance payments made under P-045 or P-045.2 remaining on account above the value for the charges shall be returned to Purchaser within 30 days following the final report of charges. Refunds not made within the 30 day period will accrue interest at the interest rate, as established by WAC 332-100-030, computed on a daily basis until paid.

P-090 Performance Security

Purchaser agrees to furnish, within 30 days of the confirmation date, security acceptable to the State in the amount of \$57,400.00. The Security provided shall guarantee performance of all provisions of this contract and payment of any damages caused by operations under this contract or resulting from Purchaser's noncompliance with any rule or law. Acceptable performance security may be in the form of a performance bond, irrevocable letter of credit, cash, savings or certificate of deposit account assignments, and must name the State as the obligee or beneficiary. A letter of credit must comply with Title 62A RCW, Article 5. Performance security must remain in full force over the duration of the contract length. Surety bonds issued shall conform to the issuance and rating requirements in clause G-150. The State shall retain the performance security pursuant to RCW 79.15.100. Purchaser shall not operate unless the performance security has been accepted by the State. If at any time the State decides that the security document or amount has become unsatisfactory, Purchaser agrees to suspend operations and, within 30 days of notification, to replace the security with one acceptable to the State or to supplement the amount of the existing security.

P-100 Performance Security Reduction

The State may reduce the performance security after an operating release has been issued if the State determines that adequate security exists for any remaining obligations of Purchaser.

Section H: Harvesting Operations

H-010 Cutting and Yarding Schedule

Falling and Yarding will not be permitted from November 1 to March 31 BY GROUND-BASED EQUIPMENT unless authorized in writing by the Contract Administrator.

H-013 Reserve Tree Damage Definition

Reserve trees are trees required and designated for retention within the sale boundary. Purchaser shall protect reserve trees from being cut, damaged, or removed during operations.

Reserve tree damage exists when one or more of the following criteria occur as a result of Purchaser's operation, as determined by the Contract Administrator:

- a. A reserve tree has one or more scars on its trunk exposing the cambium layer, which in total exceeds 288 square inches.
- b. A reserve tree top is broken or the live crown ratio is reduced below 30 percent.
- c. A reserve tree has more than 1/3 of the circumference of its root system injured such that the cambium layer is exposed.

If the Contract Administrator determines that a reserve tree has been cut or damaged, the Purchaser shall provide a replacement reserve tree of like condition, size, and species within the sale unit containing the damaged leave tree, as approved by the Contract Administrator. Purchaser may be required to pay liquidated damages for Excessive Reserve Tree Damage as detailed in clause D-041.

Removal of designated reserve trees from the sale area is unauthorized, and may invoke the use of the G-230 'Unauthorized Activity' clause. Purchaser is required to leave all cut or damaged reserve trees on site.

H-016 Skid Trail Requirements

A skid trail is defined as an area that is used for more than three passes by any equipment.

Purchaser shall comply with the following during the yarding operation:

- a. A skid trail will not exceed 12 feet in width, including rub trees.

- b. Skid trails shall not cover more than 15 percent of the total acreage on one unit.
- c. Location of the skid trails must be marked by Purchaser and approved by the Contract Administrator.
- d. Except for rub trees, skid trails shall be felled and yarded prior to the felling of adjacent timber.
- e. Rub trees shall be left standing until all timber tributary to the skid trail has been removed.
- f. Excessive soil damage is not permitted. Excessive soil damage is described in clause H-017.
- g. Purchaser will not have more than two skid trails open to active skidding at any one time. All other skid trails used for skidding timber will be closed.
- h. Once a skid trail is closed, Purchaser will not reopen a skid trail unless approved in writing by the Contract Administrator.
- i. Skid trails will be water barred at the time of completion of yarding, if required by the Contract Administrator.

Purchaser shall not deviate from the requirements set forth in this clause without prior written approval from the Contract Administrator.

#### H-017 Preventing Excessive Soil Disturbance

Operations may be suspended when soil rutting exceeds 8 inches as measured from the natural ground line. To reduce soil damage, the Contract Administrator may require water bars to be constructed, grass seed to be placed on exposed soils, or other mitigation measures. Suspended operations shall not resume unless approval to do so has been given, in writing, by the Contract Administrator.

#### H-051 Branding and Painting

Purchaser shall provide a State of Washington registered log brand, acceptable to the State, unless the State agrees to furnish the brand. All purchased timber shall be branded in a manner that meets the requirements of WAC 240-15-030(2)(a)(i). All timber purchased under a contract designated as export restricted shall also be painted in a manner that meets the requirements of WAC 240-15-030(2)(a)(ii).

For pulp loads purchased under a contract designated as export restricted, Purchaser shall brand at least 3 logs with legible brands at one end. Also, 10 logs shall be painted at one end with durable red paint.



**H-090 Designated Trees Felled**

All cottonwood shall be felled concurrently with the falling operation and must be yarded to a landing or girdled and left standing (upon approval of the Contract Administrator).

**H-120 Harvesting Equipment**

Forest products sold under this contract shall be harvested and removed using cable, tethered equipment (See H-141 for restrictions); shovel or 6-wheeled-rubber-tired-skidders-with-over-the-tire-tracks-spanning-both-sets-of-rear-tires (See H-141 for restrictions) on sustained slopes 40% or less; self-leveling equipment on sustained slopes 50% or less (See H-141 for restrictions). Authority to use other equipment or to operate outside the equipment specifications detailed above must be approved in writing by the State.

**H-130 Hauling Schedule**

The hauling of forest products will not be permitted on any road from November 1 to March 31 unless authorized in writing by the Contract Administrator.

**H-140 Special Harvest Requirements**

Purchaser shall accomplish the following during the harvest operations:

**A. The following types of equipment are considered ground-based equipment:**

SHOVEL is defined as a low ground pressure track-mounted machine with hydraulic boom and grapple capable of picking up one end of the largest log 25 feet from the center of the machine.

RUBBER-TIRED SKIDDER is defined as a skidder mounted on rubber tires used to drag logs to a landing. Logs are generally pulled in groups of six or less, with one end on the ground.

B. Equipment shall remain at least 30 feet from all water courses or areas of wet/soft soils, except as necessary to cross at approved locations. Water course crossing structures must be approved by the Contract Administrator.

C. When yarding and loading operations are occurring simultaneously, an additional shovel shall be required for loading to avoid extra trips to the landing. Shovel yarding shall not be allowed to create ruts or soil puddling. Shovel routes should be dispersed to prevent creation of definable trails.

D. An on-site pre-work meeting that includes the Contract Administrator and Purchaser will be required after operations have been disrupted (leading to a cessation of operations) or operations moved off site for a period of more than two weeks before any activities resume on site.

E. No operations are allowed to occur within the adjacent utility right-of-way. Also, no operations are allowed to restrict vehicular access to the adjacent utility right-of-way from the CT-ML Road.

F. All black cottonwood must be felled (H-90) and yarded to a landing or girdled and left standing. Girdling requirements are two full greater than 3 inch wide rings around the bole that greater than 3 inches apart. Cottonwoods within falling distance of an active road may not be girdled, and must be felled and yarded to a landing.

G. Leave trees marked with a single blue band may be exchanged for unmarked trees of similar size and wildlife characteristics upon prior approval by the Contract Administrator.

H. The Purchaser shall develop a safety plan and have an onsite discussion with the Contract Administrator at least 2 weeks before harvesting timber immediately adjacent to the structure adjacent to Unit 1. See Timber Sale map for location of structure.

I. Per the S-020 Clause, all logging slash and debris must be pulled back and piled a minimum of 200 feet from structure adjacent to Unit 1.

J. All timber falling and hauling operations are not allowed to occur prior to 7:00 a.m. daily.

K. The CT-ML gate must be closed and locked at the end of each work shift.

Permission to do otherwise must be granted in writing by the Contract Administrator.

#### H-141 Additional Harvest Requirements

Purchaser shall accomplish the following during the harvest operations:

A. A copy of the timber sale map, contract, and the FPA shall be present on site during active operations.

B. The Purchaser must obtain written approval from the Contract Administrator for specifications pertaining to the use of a 6-wheeled rubber tired skidder with over-the-tire tracks spanning both sets of rear tires. This includes areas as to where to utilize this equipment as well as any additional mitigation measures set forth by the Contract Administrator. If ground disturbance is causing excessive damage, as determined by the Contract Administrator, the equipment shall no longer be authorized.

Permission to do otherwise must be granted in writing by the State.

#### H-190 Completion of Settings

Operations begun on any setting of the sale area shall be completed before any operation begins on subsequent settings unless authorized in writing by the Contract Administrator.

**H-220 Protection of Residual or Adjacent Trees**

Unless otherwise specified by this contract, the Contract Administrator shall identify damaged adjacent or leave trees that shall be paid for according to clause G-230.

**Section C: Construction and Maintenance**

**C-040 Road Plan**

Road construction and associated work provisions of the Road Plan for this sale, dated 2/8/2023 are hereby made a part of this contract.

**C-050 Purchaser Road Maintenance and Repair**

Purchaser shall perform work at their own expense on the CT-ML, CT-03 and CT-06 roads. All work shall be completed to the specifications detailed in the Road Plan.

**Section S: Site Preparation and Protection**

**S-001 Emergency Response Plan**

An Emergency Response Plan (ERP) shall be provided to the Contract Administrator containing but not limited to, valid contact numbers and procedures for medical emergencies, fire, hazardous spills, forest practice violations and any unauthorized or unlawful activity on or in the vicinity of the sale area. The Contract Administrator and the State shall be promptly notified whenever an incident occurs requiring an emergency response.

The ERP must be presented for inspection at the prework meeting and kept readily available to all personnel, including subcontractors, on site during active operations.

**S-010 Fire Hazardous Conditions**

Purchaser acknowledges that operations under this Contract may increase the risk of fire. Purchaser shall conduct all operations under this agreement following the requirements of WAC 332-24-005 and WAC 332-24-405 and further agrees to use the highest degree of care to prevent uncontrolled fires from starting.

In the event of an uncontrolled fire, Purchaser agrees to provide equipment and personnel working at the site to safely and effectively engage in first response fire suppression activity.

Purchaser's failure to effectively engage in fire-safe operations is considered a breach and may result in suspension of operations.

**S-020 Extreme Hazard Abatement**

Purchaser shall provide a written Extreme Hazard Abatement plan that meets the requirements of WAC 332-24 prior to the beginning of logging operations. The plan must be acceptable to the Contract Administrator. The plan will identify how Purchaser will accomplish abatement. Purchaser shall also provide, and keep current, a written timetable for completion of all specified work in the plan. The Contract Administrator's acceptance and approval of Purchaser's hazard abatement plan shall not

be construed as any statement or warranty that the hazard abatement plan is adequate for Purchaser's purposes or complies with applicable laws.

S-030 Landing Debris Clean Up

Landing debris shall be disposed of in a manner approved in writing by the Contract Administrator.

S-035 Logging Debris Clean Up

Slash and debris created from harvest activities shall be treated in a manner approved in writing by the Contract Administrator.

S-050 Cessation of Operations for Low Humidity

When the humidity is 30 percent or lower on the sale area, all operations must cease unless authority to continue is granted by the State in writing.

S-060 Pump Truck or Pump Trailer

Purchaser shall provide a fully functional pump truck or pump trailer equipped to meet the specifications of WAC 332-24-005 and WAC 332-24-405 during the "closed season" or as extended by the State and shall provide trained personnel to operate this equipment on the sale area during all operating periods.

S-130 Hazardous Materials

a. Hazardous Materials and Waste - Regulatory Compliance

Purchaser is responsible for understanding and complying with all applicable local, state, and federal hazardous material/waste laws and regulations for operations conducted under this contract. Such regulations pertain to, but may not be limited to, hazardous material storage, handling and transport, personnel protection, release notification and emergency response, cleanup, and waste disposal.

Purchaser shall be responsible for restoring the site in the event of a spill or other releases of hazardous material/waste during operations conducted under this contract.

b. Hazardous Materials Spill Prevention

All operations shall be conducted in a manner that avoids the release of hazardous materials, including petroleum products, into the environment (water, air or land).

c. Hazardous Materials Spill Containment, Control and Cleanup

If safe to do so, Purchaser shall take immediate action to contain and control all hazardous material spills. Purchaser shall ensure that enough quick response spill kits capable of absorbing 10 gallons of oil, coolant, solvent or contaminated water are available on site to quickly address potential spills from any piece of equipment at all times throughout active operations. If large quantities of bulk fuel/other hazardous materials are stored on site, Purchaser must be able to effectively control a container leak and contain & recover a hazmat spill equal to the largest single on site storage container volume. (HAZWOPER reg. 29CFR 1910.120 (j) (1) (vii)).

d. Hazardous Material Release Reporting

Releases of oil or hazardous materials to the environment must be reported according to the State Department of Ecology (ECY). It is the responsibility of the Purchaser to have all emergency contact information readily available and a means of remote communication for purposes of quick notification. In the event of a spill covered in part a., the Purchaser is responsible for immediately notifying all the following:

- Department of Emergency Management at 1-800-258-5990
- National Response Center at 1-800-424-8802
- Appropriate Department of Ecology (ECY) at 1-800-645-7911
- DNR Contract Administrator

S-131 Refuse Disposal

As required by RCW 70.93, All Purchaser generated refuse shall be removed from state lands for proper disposal prior to termination of this contract. No refuse shall be burned, buried or abandoned on state forest lands. All refuse shall be transported in a manner such that it is in compliance with RCW 70.93 and all loads or loose materials shall be covered/secured such that these waste materials are properly contained during transport.

Section D: Damages

D-013 Liquidated Damages or Failure to Perform

The following clauses provide for payments by Purchaser to the State for breaches of the terms of this contract other than failure to perform. These payments are agreed to as liquidated damages and not as penalties. They are reasonable estimates of anticipated harm to the State, which will be caused by Purchaser's breach. These liquidated damages provisions are agreed to by the State and Purchaser with the understanding of the difficulty of proving loss and the inconvenience or infeasibility of obtaining an adequate remedy. These liquidated damages provisions provide greater certainty for the Purchaser by allowing the Purchaser to better assess its responsibilities under the contract.

Clause P-020 governs Purchaser's liability in the event Purchaser fails to perform any of the contract requirements other than the below liquidated damage clauses without

written approval by the State. Purchaser’s failure to pay for all or part of the forest products sold in this contract prior to expiration of the contract term results in substantial injury to the State. Therefore, Purchaser agrees to pay the State the full lump sum contract price in P-020 in the event of failure to perform.

D-041 Reserve Tree Excessive Damage

When Purchaser’s operations exceed the damage limits set forth in clause H-013, Reserve Tree Damage Definition, and when the Contract Administrator determines that a suitable replacement for a damaged reserve tree is not possible, the damaged trees result in substantial injury to the State. The value of the damaged reserve trees at the time of the breach is not readily ascertainable. Therefore, the Purchaser agrees to pay the State as liquidated damages at the rate of \$1,000.00 per tree for all damaged reserve trees that are not replaced in the sale area.

SIGNATURES

This agreement may be executed in any number of counterparts (including by electronic mail in portable document format (.pdf), or by facsimile) each of which shall be deemed an original but all of which, when taken together, shall constitute one and the same Agreement binding on all parties.

IN WITNESS WHEREOF, the Parties hereto have entered into this contract.

STATE OF WASHINGTON  
DEPARTMENT OF NATURAL RESOURCES

\_\_\_\_\_

Print Name

Date: \_\_\_\_\_

Address: \_\_\_\_\_

\_\_\_\_\_

Jay Guthrie

Northwest Region Manager

Date: \_\_\_\_\_

CORPORATE ACKNOWLEDGEMENT  
(Required for both LLC and Inc. Entities)

STATE OF \_\_\_\_\_ )

COUNTY OF \_\_\_\_\_ )

On this \_\_\_\_\_ day of \_\_\_\_\_, 20\_\_\_\_, before me personally  
appeared \_\_\_\_\_

\_\_\_\_\_ to me known to be the  
\_\_\_\_\_ of the corporation  
that executed the within and foregoing instrument and acknowledged said instrument to be the  
free and voluntary act and deed of the corporation, for the uses and purposes therein mentioned,  
and on oath stated that (he/she was) (they were) authorized to execute said instrument.

IN WITNESS WHEREOF, I have hereunto set my hand and affixed my official seal the day and  
year first above written.

\_\_\_\_\_  
Notary Public in and for the State of

\_\_\_\_\_

My appointment expires \_\_\_\_\_



**WASHINGTON STATE DEPARTMENT OF NATURAL RESOURCES**  
**FOREST EXCISE TAX ROAD SUMMARY SHEET**

**Region:**

**Timber Sale Name:**

**Application Number:**

**EXCISE TAX APPLICABLE ACTIVITIES**

**Construction:** **linear feet**  
*Road to be constructed (optional and required) but not abandoned*

**Reconstruction:** **linear feet**  
*Road to be reconstructed (optional and required) but not abandoned*

**Abandonment:** **linear feet**  
*Abandonment of existing roads not reconstructed under the contract*

**Decommission:** **linear feet**  
*Road to be made undriveable but not officially abandoned.*

**Pre-Haul Maintenance:** **linear feet**  
*Existing road to receive maintenance work (optional and required) prior to haul*

**EXCISE TAX EXEMPT ACTIVITIES**

**Temporary Construction:** **linear feet**  
*Roads to be constructed (optional and required) and then abandoned*

**Temporary Reconstruction:** **linear feet**  
*Roads to be reconstructed (optional and required) and then abandoned*

All parties must make their own assessment of the taxable or non-taxable status of any work performed under the timber sale contract. The Department of Revenue bears responsibility for determining forest road excise taxes. The Department of Natural Resources developed this form to help estimate the impact of forest excise taxes. However, the information provided may not precisely calculate the actual amount of taxes due. The Department of Revenue is available for consultation by calling 1.800.548.8829.  
(Revised 9/18)



## Timber Sale Cruise Report Extra Christie - NW

**Sale Name:** EXTRA CHRISTIE

**Sale Type:** LUMP SUM

**Region:** NORTHWEST

**District:** BAKER

**Lead Cruiser:** Matt Llobet

**Other Cruisers:** MS, BV

Extra Christie is located north of Sedro Woolley off Innis Creek road. It consists of two Variable Retention Units (VRH). Topography is flat with a gentle gradient in some areas and forest roads provide drive access to both units. Extra Christie ranges in elevation from 320'-520'.

For this cruise different basal area factors were selected based on stocking levels and tree sizes. My plots were generated in GIS and located in the field using Avenza Maps. Bole heights were measured with a laser and taken to a 5" top or break point (40% of diameter at 16 feet). Trees were segmented into appropriate log lengths and defect was applied accordingly.

Conifer log lengths were cruised in 2 foot multiples - maximizing 32-40 ft. lengths. Hardwood log lengths were cruised in 10 foot multiples - no longer than 30 feet long.

If a plot landed near or in a "Leave Tree Area" the leave trees were recorded as leave. A species and DBH was obtained. This volume is not included in the sale volume. Cruise acres are based on FMA acres including leave tree areas.

My total net cruise volume for Extra Christie is 734 MBF.

### Unit 1:

The stand characteristics throughout unit 1 showed a homogenous timber type with an open understory. The terrain throughout unit 1 was mild - making for good operator ground. Unit 1 cruised out at 20,849 bf per acre of sawlog volume and all live timber showed excellent form. The species composition consists of Douglas fir, Western Hemlock, Western Red Cedar, and scattered hardwoods. The Douglas fir made up 88% of the unit volume amounting to 194 MBF. A small component of Western Red Cedar was scattered throughout the unit amounting to 6 MBF. Douglas fir pole volume was observed amounting to 24 MBF.

### Unit 2:

The stand consists of a variable stocking with straightforward operator ground. The species composition consists of Douglas fir, Western Hemlock, Western Red Cedar, and hardwoods. Unit 2 cruised out at 56,373 bf per acre of sawlog volume and all timber showed good form. The Douglas fir made up 87% of the unit volume amounting to 448 MBF. The Douglas fir showed high quality segments consistently throughout the unit. Throughout unit 2 - 88 MBF of Douglas fir pole volume was cruise.

## Timber Sale Notice Volume (MBF)

Sp	DBH	Rings/In	Age	MBF Volume by Grade						
				All	Peeler	Spec Mill	2 Saw	3 Saw	4 Saw	Utility
DF	22.5	7.0	643	<del>642</del>	25	105	370	122	21	
WH	18.5		50	<del>51</del>			30	15	3	2
RC	17.5		22	<del>23</del>			<del>1</del>	17	4	
MA	16.7			16			4	6	4	<del>1</del> 2
BC	18.0			3			2		1	
ALL	20.7	7.0		734	25	105	407	160	33	4

## Timber Sale Notice Weight (tons)

Sp	Tons by Grade						
	All	Peeler	Spec Mill	2 Saw	3 Saw	4 Saw	Utility
DF	4,158	127	577	2,292	962	201	
WH	449			246	141	38	24
RC	219			5	154	60	
MA	141			31	59	39	12
BC	20			15		5	
ALL	4,987	127	577	2,589	1,315	343	36

## Timber Sale Overall Cruise Statistics (Cut + Leave Trees)

BA (sq ft/acre)	BA SE (%)	V-BAR (bf/sq ft)	V-BAR SE (%)	Net Vol (bf/acre)	Vol SE (%)
246.0	7.1	160.7	2.9	41,536	7.8

## Timber Sale Unit Cruise Design

Unit	Design	Cruise Acres	FMA Acres	N Plots	N Cruise Plots	N Void Plots
EXTRA CHRISTIE 1	B1: VR, 1 BAF (40) Measure All, Sighting Ht = 4.5 ft	10.5	10.6	21	21	0
EXTRA CHRISTIE 2	B2: VR, 2 BAF (62.5, 40 for some species) Measure All, Sighting Ht = 4.5 ft	9.1	9.1	20	20	0
All		19.6	19.7	41	41	0

**Timber Sale Log Grade x Sort Summary**

Sp	Status	Grade	Sort	Dia	Len	BF Gross	BF Net	Defect %	Tons	MBF Net
BC	LIVE	2 SAW	Domestic	12.3	40	113	113	0.0	14.7	2.2
BC	LIVE	4 SAW	Domestic	7.9	30	28	28	0.0	5.0	0.5
DF	LIVE	2 SAW	Domestic	15.6	35	12,336	11,993	2.8	1,444.1	235.1
DF	LIVE	2 SAW	HQ-A	20.5	34	1,705	1,705	0.0	181.0	33.4
DF	LIVE	2 SAW	HQ-B	15.4	37	2,816	2,802	0.5	360.3	54.9
DF	LIVE	2 SAW	Pole	14.7	40	2,351	2,351	0.0	306.3	46.1
DF	LIVE	3 PEELER	HQ-A	27.4	34	1,303	1,290	1.0	127.1	25.3
DF	LIVE	3 SAW	Domestic	9.4	34	5,696	5,615	1.4	870.5	110.0
DF	LIVE	3 SAW	HQ-B	11.8	32	93	83	10.4	11.2	1.6
DF	LIVE	3 SAW	Pole	9.1	35	503	503	0.0	80.2	9.9
DF	LIVE	4 SAW	Domestic	6.5	24	1,094	1,064	2.7	200.9	20.9
DF	LIVE	CULL	Cull	24.5	10	154	0	100.0	0.0	0.0
DF	LIVE	SPECIAL MILL	HQ-A	19.7	36	5,350	5,350	0.0	577.0	104.9
MA	LIVE	2 SAW	Domestic	17.4	26	262	225	13.8	31.1	4.4
MA	LIVE	3 SAW	Domestic	10.8	30	332	321	3.3	58.5	6.3
MA	LIVE	4 SAW	Domestic	7.8	30	208	208	0.0	39.4	4.1
MA	LIVE	UTILITY	Pulp	9.6	28	71	71	0.0	12.1	1.4
RC	LIVE	2 SAW	Domestic	21.0	32	71	71	0.0	5.3	1.4
RC	LIVE	3 SAW	Domestic	9.2	37	859	854	0.6	153.8	16.7
RC	LIVE	4 SAW	Domestic	6.4	27	224	224	0.0	60.0	4.4
RC	LIVE	CULL	Cull	26.5	16	58	0	100.0	0.0	0.0
WH	LIVE	2 SAW	Domestic	13.7	37	1,621	1,526	5.8	245.8	29.9
WH	LIVE	3 SAW	Domestic	9.4	35	785	785	0.0	141.2	15.4
WH	LIVE	4 SAW	Domestic	7.1	26	185	153	17.0	37.8	3.0
WH	LIVE	UTILITY	Pulp	10.9	24	117	117	0.0	24.0	2.3

**Timber Sale Log Sort x Diameter Bin Summary**

Sp	Bin	Status	Sort	Dia	Len	BF Net	Defect %	Tons	MBF Net
BC	5+	LIVE	Domestic	10.1	35	141	0.0	19.7	2.8
DF	5 - 8	LIVE	Domestic	7.0	28	2,602	0.8	482.3	51.0
DF	5 - 8	LIVE	Pole	8.4	37	194	0.0	36.7	3.8
DF	9 - 11	LIVE	Pole	9.7	34	309	0.0	43.4	6.1
DF	9 - 11	LIVE	Domestic	10.5	32	4,019	2.2	581.5	78.8
DF	9 - 11	LIVE	HQ-B	11.8	32	83	10.4	11.2	1.6
DF	12 - 14	LIVE	Domestic	13.4	36	4,300	1.5	592.7	84.3
DF	12 - 14	LIVE	Pole	13.4	40	1,077	0.0	153.1	21.1

Sp	Bin	Status	Sort	Dia	Len	BF Net	Defect %	Tons	MBF Net
DF	12 - 14	LIVE	HQ-B	14.2	38	1,270	1.1	184.0	24.9
DF	12 - 14	LIVE	HQ-A	14.7	40	163	0.0	23.9	3.2
DF	15 - 19	LIVE	Pole	16.6	40	1,275	0.0	153.1	25.0
DF	15 - 19	LIVE	Domestic	16.7	35	5,016	2.3	575.2	98.3
DF	15 - 19	LIVE	HQ-B	17.0	36	1,386	0.0	163.4	27.2
DF	15 - 19	LIVE	HQ-A	18.1	37	2,343	0.0	268.2	45.9
DF	20+	LIVE	HQ-B	20.9	32	145	0.0	12.9	2.9
DF	20+	LIVE	Domestic	22.5	33	2,735	5.6	283.7	53.6
DF	20+	LIVE	HQ-A	22.5	34	5,838	0.2	592.9	114.4
DF	20+	LIVE	Cull	24.5	10	0	100.0	0.0	0.0
MA	5+	LIVE	Pulp	9.6	28	71	0.0	12.1	1.4
MA	5+	LIVE	Domestic	10.0	30	755	5.9	129.1	14.8
RC	5+	LIVE	Domestic	7.8	32	1,148	0.5	219.2	22.5
RC	5+	LIVE	Cull	26.5	16	0	100.0	0.0	0.0
WH	5 - 8	LIVE	Domestic	7.4	30	351	8.2	79.1	6.9
WH	5 - 8	LIVE	Pulp	7.4	16	12	0.0	3.2	0.2
WH	9 - 11	LIVE	Domestic	10.2	34	588	0.0	99.8	11.5
WH	12 - 14	LIVE	Domestic	13.3	37	1,224	6.7	201.4	24.0
WH	12 - 14	LIVE	Pulp	14.4	32	105	0.0	20.9	2.1
WH	15 - 19	LIVE	Domestic	16.5	37	302	2.2	44.4	5.9

## Cruise Unit Report EXTRA CHRISTIE 1

### Unit Sale Notice Volume (MBF): EXTRA CHRISTIE 1

Sp	DBH	Rings/In	Age	MBF Volume by Grade				
				All	2 Saw	3 Saw	4 Saw	Utility
DF	18.5	7.0		194	118	64	12	
WH	18.3			11	7	3	1	
MA	17.9			8	3	2	2	1
RC	20.5			6		5	1	
BC	18.0			3	2		1	
ALL	18.6	7.0		221	130	73	16	1

### Unit Cruise Design: EXTRA CHRISTIE 1

Design	Cruise Acres	FMA Acres	N Plots	N Cruise Plots	N Void Plots
B1: VR, 1 BAF (40) Measure All, Sighting Ht = 4.5 ft	10.5	10.6	21	21	0

### Unit Cruise Summary: EXTRA CHRISTIE 1

Sp	Cruised Trees	All Trees	Trees/Plot	Ring-Count Trees
RA		1	0.0	0
DF	64	65	3.1	1
WH	4	9	0.4	0
RC	4	13	0.6	0
MA	5	6	0.3	0
BC	1	1	0.0	0
ALL	78	95	4.5	1

### Unit Cruise Statistics (Cut + Leave Trees): EXTRA CHRISTIE 1

Sp	BA (sq ft/acre)	BA CV (%)	BA SE (%)	V-BAR (bf/sq ft)	V-BAR CV (%)	V-BAR SE (%)	Net Vol (bf/acre)	Vol CV (%)	Vol SE (%)
RA	1.9	458.3	100.0						
DF	123.8	92.5	20.2	151.5	24.3	3.0	18,760	95.6	20.4
WH	17.1	228.3	49.8	134.8	7.5	3.7	2,311	228.4	50.0
RC	24.8	165.3	36.1	70.0	58.9	29.5	1,733	175.5	46.6
MA	11.4	196.2	42.8	77.5	34.1	15.2	886	199.2	45.4
BC	1.9	458.3	100.0	138.1	0.0	0.0	263	458.3	100.0

Sp	BA (sq ft/acre)	BA CV (%)	BA SE (%)	V-BAR (bf/sq ft)	V-BAR CV (%)	V-BAR SE (%)	Net Vol (bf/acre)	Vol CV (%)	Vol SE (%)
ALL	181.0	57.5	12.5	133.8	32.0	3.6	24,207	65.8	13.1

**Unit Summary: EXTRA CHRISTIE 1**

Sp	Status	Rx	N	D	DBH	BL	THT	BF Gross	BF Net	Defect %	TPA	BA	RD	MBF Net
BC	LIVE	CUT	1	ALL	18.0	82	102	263	263	0.0	1.1	1.9	0.4	2.8
DF	LIVE	CUT	56	ALL	18.2	77	99	16,267	16,162	0.6	59.0	106.7	25.0	169.7
DF	LIVE	POLE	8	ALL	21.3	93	118	2,324	2,309	0.6	6.2	15.2	3.3	24.2
DF	LIVE	LEA	0	ALL	22.6			290	289	0.6	0.7	1.9	0.4	3.0
MA	LIVE	CUT	5	ALL	17.9	52	71	810	739	8.9	5.4	9.5	2.3	7.8
MA	LIVE	LEA	0	ALL	16.0			162	148	8.9	1.4	1.9	0.5	1.6
RA	LIVE	LEA	1	ALL	16.2	73	90				1.3	1.9	0.5	
RC	LIVE	CUT	3	ALL	20.4	51	62	407	400	1.8	2.5	5.7	1.3	4.2
RC	LIVE	POLE	1	ALL	20.6	50	62	136	133	1.8	0.8	1.9	0.4	1.4
RC	LIVE	LEA	0	ALL	32.1			1,222	1,199	1.8	3.1	17.1	3.0	12.6
WH	LIVE	CUT	4	ALL	18.3	74	94	1,050	1,027	2.2	4.2	7.6	1.8	10.8
WH	LIVE	LEA	0	ALL	13.3			1,312	1,284	2.2	9.9	9.5	2.6	13.5
ALL	LIVE	LEA	1	ALL	19.1	73	90	2,987	2,919	2.2	16.4	32.4	7.0	30.7
ALL	LIVE	CUT	69	ALL	18.3	74	95	18,798	18,590	1.1	72.2	131.4	30.7	195.2
ALL	LIVE	POLE	9	ALL	21.2	88	112	2,460	2,442	0.7	7.0	17.1	3.7	25.6
ALL	ALL	ALL	79	ALL	18.6	75	97	24,244	23,952	1.2	95.6	181.0	41.5	251.5

## Cruise Unit Report EXTRA CHRISTIE 2

### Unit Sale Notice Volume (MBF): EXTRA CHRISTIE 2

Sp	DBH	Rings/In	Age	MBF Volume by Grade						
				All	Peeler	Spec Mill	2 Saw	3 Saw	4 Saw	Utility
DF	24.2			448	25	105	251	57	9	
WH	18.5			40			23	13	2	2
RC	16.5			17			1	12	3	
MA	15.6			8			1	4	3	
ALL	21.6			513	25	105	277	87	17	2

### Unit Cruise Design: EXTRA CHRISTIE 2

Design	Cruise Acres	FMA Acres	N Plots	N Cruise Plots	N Void Plots
B2: VR, 2 BAF (62.5, 40 for some species) Measure All, Sighting Ht = 4.5 ft	9.1	9.1	20	20	0

### Unit Cruise Summary: EXTRA CHRISTIE 2

Sp	Cruised Trees	All Trees	Trees/Plot	Ring-Count Trees
DF	71	78	3.9	0
WH	10	10	0.5	0
RC	15	16	0.8	0
MA	5	7	0.4	0
ALL	101	111	5.6	0

### Unit Cruise Statistics (Cut + Leave Trees): EXTRA CHRISTIE 2

Sp	BA (sq ft/acre)	BA CV (%)	BA SE (%)	V-BAR (bf/sq ft)	V-BAR CV (%)	V-BAR SE (%)	Net Vol (bf/acre)	Vol CV (%)	Vol SE (%)
DF	243.8	53.8	12.0	221.9	29.2	3.5	54,093	61.3	12.5
WH	31.3	177.7	39.7	140.0	29.2	9.2	4,376	180.1	40.8
RC	32.0	104.2	23.3	61.9	54.3	14.0	1,982	117.5	27.2
MA	14.0	212.9	47.6	77.1	36.9	16.5	1,080	216.1	50.4
ALL	321.0	38.0	8.5	191.7	44.6	4.4	61,530	58.6	9.6

**Unit Summary: EXTRA CHRISTIE 2**

Sp	Status	Rx	N	D	DBH	BL	THT	BF Gross	BF Net	Defect %	TPA	BA	RD	MBF Net
DF	LIVE	CUT	57	ALL	24.3	96	122	40,532	39,529	2.5	55.3	178.1	36.1	359.7
DF	LIVE	POLE	14	ALL	23.7	102	131	9,955	9,709	2.5	14.3	43.8	9.0	88.4
DF	LIVE	LEA	0	ALL	17.5			4,978	4,854	2.5	13.1	21.9	5.2	44.2
MA	LIVE	CUT	5	ALL	15.6	47	66	944	925	1.9	9.0	12.0	3.0	8.4
MA	LIVE	LEA	0	ALL	17.2			157	154	1.9	1.2	2.0	0.5	1.4
RC	LIVE	CUT	15	ALL	16.5	42	61	1,983	1,858	6.3	20.2	30.0	7.4	16.9
RC	LIVE	LEA	0	ALL	15.8			132	124	6.3	1.5	2.0	0.5	1.1
WH	LIVE	CUT	10	ALL	18.5	80	101	4,621	4,376	5.3	16.7	31.3	7.3	39.8
ALL	LIVE	CUT	87	ALL	21.3	78	101	48,080	46,689	2.9	101.2	251.4	53.8	424.9
ALL	LIVE	POLE	14	ALL	23.7	102	131	9,955	9,709	2.5	14.3	43.8	9.0	88.4
ALL	LIVE	LEA	0	ALL	17.3			5,267	5,133	2.6	15.8	25.9	6.2	46.7
ALL	ALL	ALL	101	ALL	21.2	81	105	63,303	61,530	2.8	131.3	321.0	69.0	559.9



# Extra Christie - NW

Eberly\_Christie\_Units

● Extra\_Christie\_Pts

Leave Tree Area

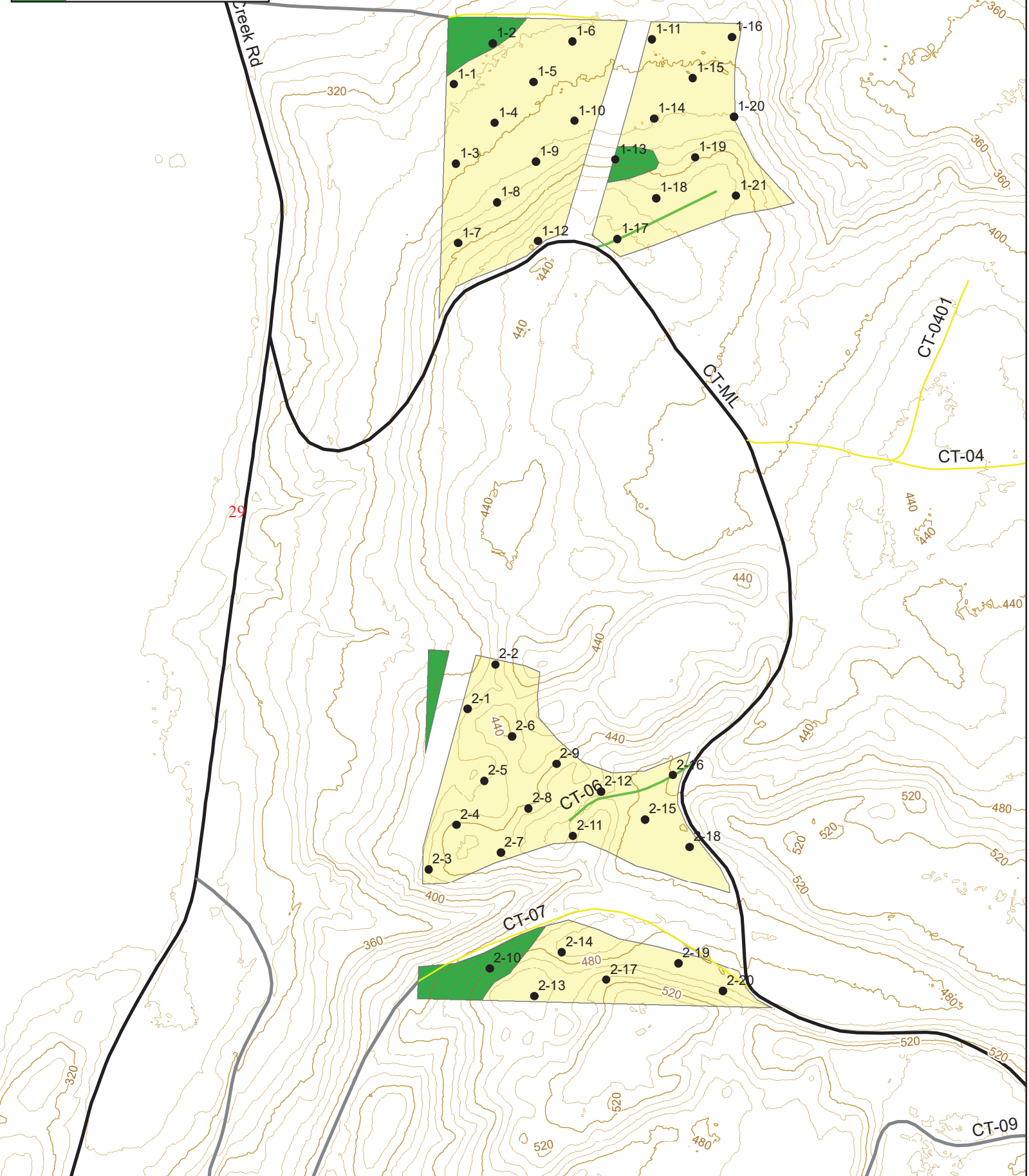



Forest Practices Application/Notification
Notice of Decision

FPA/N No: 2818977
Effective Date: 5/18/2023
Expiration Date: 5/18/2026
Shut Down Zone: 656
EARR Tax Credit: [X] Eligible [ ] Non-eligible
Reference: Extra Christie

Decision

- Notification Accepted Operations shall not begin before the effective date.
[X] Approved This Forest Practices Application is subject to the conditions listed below.
[ ] Disapproved This Forest Practices Application is disapproved for the reasons listed below.
[ ] Withdrawn Applicant has withdrawn the Forest Practices Application/Notification (FPA/N).
[ ] Closed All forest practices obligations are met.

FPA/N Classification

- [ ] Class II [X] Class III [ ] Class IVG [ ] Class IVS

Number of Years Granted on Multi-Year Request

- [ ] 4 years [ ] 5 years

Conditions on Approval/Reasons for Disapproval

Timing Limitations on Type S and F water(s):

No timing limitations apply.

Condition(s) required for approval/disapproval:

No additional conditions apply.

Notes:

A ~ 300' segment of stream B, upstream of the modeled F/N break was identified as potential fish habitat. This segment does not effect this proposal, however, it was discussed and agreed upon that if this segment goes dry, a water type modification could be submitted by the landowner to further confirm the location of the current modeled F/N break.

Issued By: Zachary Bastow

Region: Northwest Region

Title: Resource Protection Forester

Date: 5/18/2023

Copies to: [ ] Landowner, Timber Owner, and Operator

Issued in person: [X] LO [X] TO [X] OP

By: [Signature]

Date: 05/18/2023



# ROAD PLAN AND SPECIFICATIONS #30-104583 EXTRA CHRISTIE



WASHINGTON STATE  
DEPT. OF NATURAL RESOURCES  
NORTHWEST REGION

19

20

21

22

SHEET INDEX	
PROJECT MAP.....	1
ROAD CLAUSES .....	2-20
TYPICAL SECTION.....	21
MATERIAL LIST.....	22
FARMS.....	23-24
STANDARD DETAILS.....	25

30

T37R05E

29

28

27

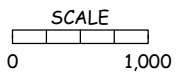
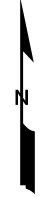

LEGEND	
PRE-HAUL MAINTENANCE	—————
REQUIRED CONSTRUCTION	=====
OPTIONAL CONSTRUCTION	- - - - -
REQUIRED RECONSTRUCTION	
OPTIONAL RECONSTRUCTION	+++++

31

33

34

DESIGNED BY	REVIEWED BY	APPROVED BY	PLAN DATE	SHEET
VAN HOLLEBEKE	ZYLSTRA 3/8/2023	ZYLSTRA 3/8/2023	3/8/2023	1 OF 25

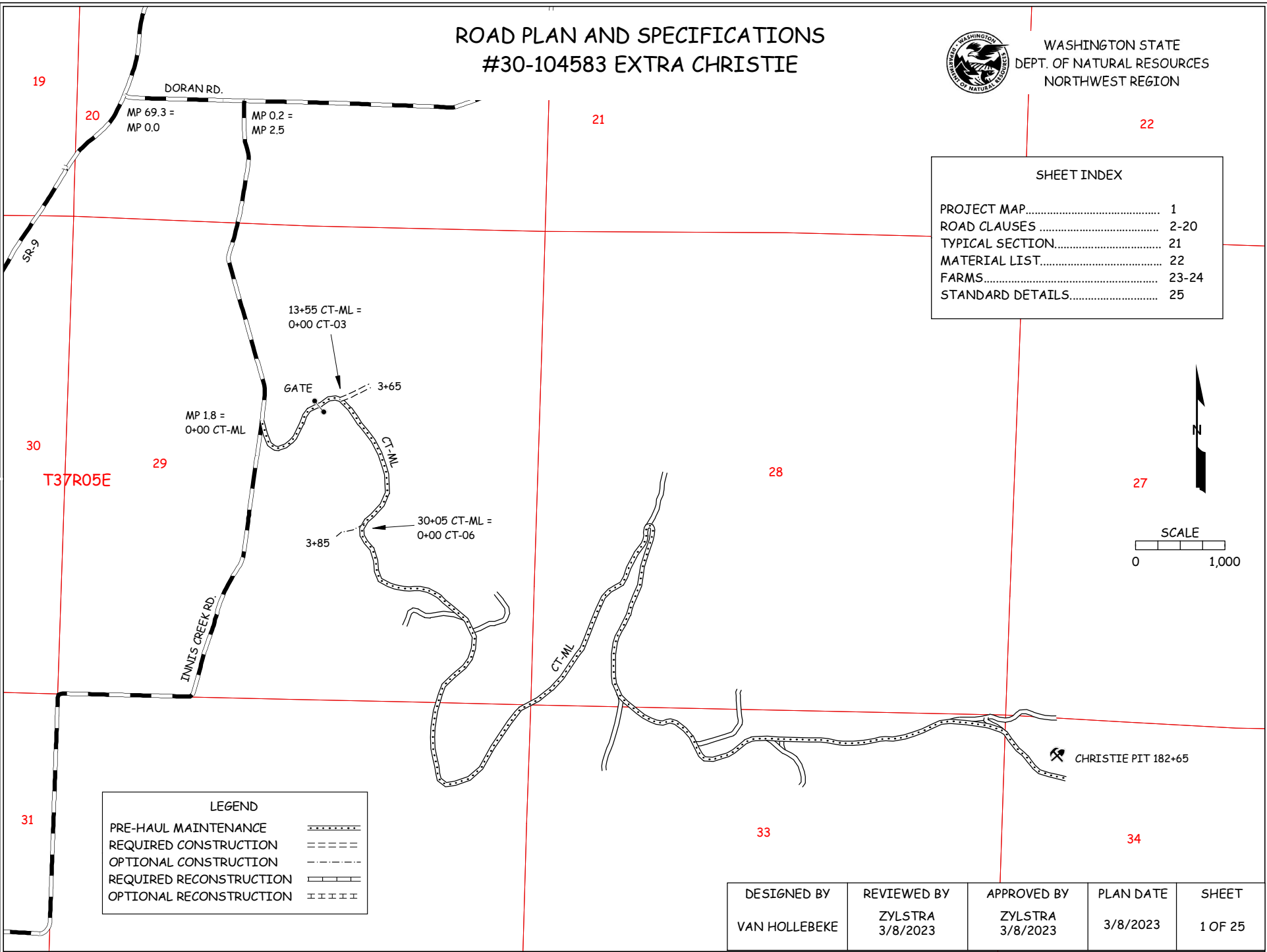

STATE OF WASHINGTON  
DEPARTMENT OF NATURAL RESOURCES

EXTRA CHRISTIE TIMBER SALE ROAD PLAN  
WHATCOM COUNTY  
BAKER DISTRICT  
NORTHWEST REGION

AGREEMENT NO.: 30-104583

STAFF ENGINEER: VAN HOLLEBEKE

DATE: 2/8/2023

SECTION 0 – SCOPE OF PROJECT

**0-1 ROAD PLAN SCOPE**

Clauses in this road plan apply to all road related work, including landings and rock source development, unless otherwise noted.

**0-2 REQUIRED ROADS**

The specified work on the following roads is required.

<u>Road</u>	<u>Stations</u>	<u>Type</u>
CT-ML	0+00 to 182+65	Pre-haul Maintenance
CT-03	0+00 to 3+65	Construction

**0-3 OPTIONAL ROADS**

The specified work on the following roads is not required. Any optional roads built by the Purchaser must meet all the specifications in the road plan.

<u>Road</u>	<u>Stations</u>	<u>Type</u>
CT-06	0+00 to 3+85	Construction

**0-4 CONSTRUCTION**

Construction includes, but is not limited to clearing, grubbing, excavation and embankment to sub-grade, landing and turnout construction, culvert installation, and application of 3-inch-minus ballast rock.

**0-6 PRE-HAUL MAINTENANCE**

This project includes, but is not limited to the following pre-haul maintenance requirements:

<u>Road</u>	<u>Stations</u>	<u>Requirements</u>
CT-ML	0+00 to 182+65	Cleaning culverts, ditches, headwalls, and catch basins. Blading, shaping, and ditching the road prism to the dimensions shown in the typical section.

**0-7 POST-HAUL MAINTENANCE**

This project includes post-haul road maintenance listed in Clause 9-5 POST-HAUL MAINTENANCE.

**0-10 ABANDONMENT**

This project includes abandonment listed in Clause 9-21 ROAD ABANDONMENT.

SECTION 1 – GENERAL

**1-1 ROAD PLAN CHANGES**

If the Purchaser desires a change from this road plan including, but not limited to, relocation, extension, change in design, or adding roads; a revised road plan must be submitted in writing to the Contract Administrator for consideration. Before work begins, Purchaser shall obtain approval from the State for any submitted plan that changes the scope of work or environmental condition from the original road plan.

**1-2 UNFORESEEN CONDITIONS**

Quantities established in this road plan are minimum acceptable values. Additional quantities required by the state due to unforeseen conditions, or Purchaser's choice of construction season or techniques will be at the Purchaser's expense. Unforeseen conditions include, but are not limited to, solid subsurface rock, subsurface springs, saturated ground, and unstable soils.

**1-3 ROAD DIMENSIONS**

Purchaser shall perform road work in accordance with the dimensions shown on the TYPICAL SECTION SHEET and the specifications within this road plan.

**1-4 ROAD TOLERANCES**

Purchaser shall perform road work within the tolerances listed below. The tolerance class for each road is listed on the TYPICAL SECTION SHEET.

<u>Tolerance Class</u>	<u>A</u>	<u>B</u>	<u>C</u>
Road and Subgrade Width (feet)	+1.5	+1.5	+2.0
Subgrade Elevation (feet +/-)	0.5	1.0	2.0
Centerline alignment (feet lt./rt.)	1.0	1.5	3.0

**1-6 ORDER OF PRECEDENCE**

Any conflict or inconsistency in the road plan will be resolved by giving the documents precedence in the following order:

1. Addenda.
2. Road Plan Clauses.
3. Typical Section Sheet.
4. Standard Lists.
5. Standard Details.

In case of any ambiguity or dispute over interpreting the road plan, the Contract Administrator’s or designee’s decision will be final.

**1-8 REPAIR OR REPLACEMENT OF DAMAGED MATERIALS**

Purchaser shall repair or replace all materials, roadway infrastructure, and road components damaged during road work or operation activities. The Contract Administrator will direct repairs and replacements. Repairs to structural materials must be made in accordance with the manufacturer’s recommendation, and may not begin without written approval from the Contract Administrator.

**1-9 DAMAGED METALLIC COATING**

Any cut ends, or damaged galvanized or aluminized coating on existing or new bridge components, culverts, downspouts, and flumes must be cleaned and treated with a minimum of two coats of zinc rich paint or cold galvanizing compound.

**1-18 REFERENCE POINT DAMAGE**

Purchaser shall reset reference points (RPs) that were moved or damaged at any time during construction to their original locations. Excavation and embankment may not proceed on road segments controlled by said RPs until Purchaser resets all moved or damaged RPs.

**1-21 HAUL APPROVAL**

Purchaser shall not use roads under this road plan for any hauling other than timber cut on the right-of-way, without written approval from the Contract Administrator.

**1-23 ROAD WORK PHASE APPROVAL**

Purchaser shall obtain approval from the Contract Administrator upon completion of each of the following phases of road work, if applicable:

- Right-of-way
  - Falling/decking
  - Clearing/grubbing
- Subgrade Construction
  - Excavation and embankment to subgrade
  - Culvert installation
  - Ditch construction
  - Subgrade compaction
- Rock application
  - Rock compaction
  - Rock depth
- Erosion and sediment control
- Revegetation
- Abandonment

**1-25 ACTIVITY TIMING RESTRICTION**

The specified activities are not allowed during the listed closure periods unless authorized in writing by the Contract Administrator.

<u>Activity</u>	<u>Closure Period</u>
All Activities	November 1 to March 31

**1-26 OPERATING DURING CLOSURE PERIOD**

If permission is granted to operate during a closure period listed in Clause 1-25 ACTIVITY TIMING RESTRICTION, Purchaser shall provide a maintenance plan to include further protection of state resources. Purchaser shall obtain written approval from the Contract Administrator for the maintenance plan, and shall put preventative measures in place before operating during the closure period. Purchaser is required to maintain all haul roads at their own expense including those listed in Contract Clause C-060 DESIGNATED ROAD MAINTAINER. If other operators are using, or desire to use these designated maintainer roads, a joint operating plan must be developed. All parties shall follow this plan.

**1-29 SEDIMENT RESTRICTION**

Purchaser shall not allow silt-bearing runoff to enter any streams.



**1-30 CLOSURE TO PREVENT DAMAGE**

In accordance with Contract Clause G-220 STATE SUSPENDS OPERATION, the Contract Administrator will suspend road work or hauling right-of-way timber, forest products, or rock under the following conditions:

- Wheel track rutting exceeds 6 inches on roads.
- Surface or base stability problems persist.
- Weather is such that satisfactory results cannot be obtained in an area of operations.
- When, in the opinion of the Contract Administrator excessive road damage or rutting may occur.

Operations must stop unless authority to continue working or hauling is granted in writing by the Contract Administrator. In the event that surface or base stability problems persist, Purchaser shall cease operations, or perform corrective maintenance or repairs, subject to specifications within this road plan. Before and during any suspension, Purchaser shall protect the work from damage or deterioration.

**1-33 SNOW PLOWING RESTRICTION**

Snowplowing will be allowed after the execution of a SNOW PLOWING AGREEMENT, which is available from the Contact Administrator upon request. If damage occurs while plowing, further permission to plow may be revoked by the Contract Administrator.

**1-40 ROAD APPROACHES TO COUNTY ROADS AND STATE HIGHWAYS**

Purchaser shall immediately remove any mud, dirt, rock, or other material tracked or spilled on to county roads and state highways.

If additional damage to the surface, signs, guardrails, etc. occurs then the damage will be repaired, at the Purchaser’s expense, as directed by the Contract Administrator when authorized by the county or WSDOT.

**1-42 UTILITY ACCESS ROAD**

The following road intersects an existing utility access road. Purchaser shall conduct road work on the intersecting roads so that the utility access roads are accessible at all times.

<u>Road</u>	<u>Stations</u>
CT-ML	12+55 to 13+55

**1-43 ROAD WORK AROUND UTILITIES**

Road work is in close proximity to a utility. Known utilities are listed, but it is the Purchaser’s responsibility to identify any utilities not listed. Purchaser shall work in accordance with all applicable laws or rules concerning utilities. Purchaser is responsible for all notification, including “call before you dig”, and liabilities associated with the utilities and their rights-of-way.

<u>Road</u>	<u>Stations</u>	<u>Utility</u>	<u>Utility Contact</u>
CT-ML	12+55 to 13+55	Northwest Pipeline Corporation	Kevin Henson (360) 961-9157

**SECTION 2 – MAINTENANCE**

**2-1 GENERAL ROAD MAINTENANCE**

Purchaser shall maintain all roads used under this contract in accordance with the FOREST ACCESS ROAD MAINTENANCE SPECIFICATIONS for the entire term of this contract. Maintenance is required even during periods of inactivity.

**2-2 ROAD MAINTENANCE – PURCHASER MAINTENANCE**

Purchaser shall perform maintenance on roads listed in Contract Clause C-050 PURCHASER ROAD MAINTENANCE AND REPAIR in accordance with FOREST ACCESS ROAD MAINTENANCE SPECIFICATIONS.

**2-5 MAINTENANCE GRADING – EXISTING ROAD**

On the following road, Purchaser shall use a grader to shape the existing surface before any hauling. Purchaser shall accomplish all grading using a motor grader with a minimum of 175 horsepower.

<u>Road</u>	<u>Stations</u>
CT-ML	0+00 to 182+65 see Clause 0-6 PRE-HAUL MAINTENANCE

**2-6 CLEANING CULVERTS**

On the following roads, Purchaser shall clean the inlets and outlets of all culverts and shall obtain written approval from the Contract Administrator before any hauling.

<u>Road</u>	<u>Stations</u>
CT-ML	0+00 to 182+65 see Clause 0-6 PRE-HAUL MAINTENANCE

**2-7 CLEANING DITCHES, HEADWALLS, AND CATCH BASINS**

On the following roads, Purchaser shall clean ditches, headwalls, and catchbasins. Work must be completed before any hauling and must be done in accordance with the TYPICAL SECTION.

<u>Road</u>	<u>Stations</u>
CT-ML	0+00 to 182+65 see Clause 0-6 PRE-HAUL MAINTENANCE

**SECTION 3 – CLEARING, GRUBBING, AND DISPOSAL**

**3-5 CLEARING**

Purchaser shall fall all vegetative material larger than 2 inches DBH or over 5 feet high between the marked right-of-way boundaries and within waste and debris areas, or if not marked in the field, between the clearing limits specified on the TYPICAL SECTION SHEET. Clearing must be completed before starting excavation and embankment.

**3-8 PROHIBITED DECKING AREAS**

Purchaser shall not deck right-of-way timber in the following areas:

- Within the grubbing limits.
- Within 50 feet of any stream.
- In locations that interfere with the construction of the road prism.
- In locations that impede drainage.
- On slopes greater than 40%.
- Against standing trees.

**3-10 GRUBBING**

Purchaser shall remove all stumps between the grubbing limits specified on the TYPICAL SECTION SHEET and within waste and debris areas. Purchaser shall also remove stumps with undercut roots outside the grubbing limits. Grubbing must be completed before starting excavation and embankment.

**3-20 ORGANIC DEBRIS DEFINITION**

Organic debris is defined as all vegetative material not eligible for removal by Contract Clause G-010 PRODUCTS SOLD AND SALE AREA or G-011 RIGHT TO REMOVE FOREST PRODUCTS AND CONTRACT AREA, that is larger than one cubic foot in volume within the clearing limits as shown on the TYPICAL SECTION SHEET.

**3-21 DISPOSAL COMPLETION**

Purchaser shall remove organic debris from the road surface, ditchlines, and culvert inlets and outlets. Purchaser shall complete all disposal of organic debris before the application of rock.

### **3-22 DESIGNATED WASTE AREA FOR ORGANIC DEBRIS**

Waste areas for organic debris are located within the cleared right-of-way or in natural openings as designated at areas approved in writing by the Contract Administrator.

### **3-23 PROHIBITED DISPOSAL AREAS**

Purchaser shall not place organic debris in the following areas:

- Within 50 feet of a cross drain culvert.
- Within 100 feet of a live stream, or wetland
- On road subgrades, or excavation and embankment slopes.
- On slopes greater than 70%.
- Within the operational area for cable landings where debris may shift or roll.
- On locations where brush can fall into the ditch or onto the road surface.
- Against standing timber.

### **3-24 BURYING ORGANIC DEBRIS RESTRICTED**

Purchaser shall not bury organic debris unless otherwise stated in this plan.

### **3-25 SCATTERING ORGANIC DEBRIS**

Purchaser shall scatter organic debris outside of the clearing limits in natural openings unless otherwise detailed in this road plan.

## **SECTION 4 – EXCAVATION**

### **4-1 EXCAVATOR CONSTRUCTION**

Purchaser shall use a track mounted hydraulic excavator for construction work, unless authorized in writing by the Contract Administrator.

### **4-2 PIONEERING**

Pioneering may not extend past construction that will be completed during the current construction season. Pioneering may not extend more than 500 feet beyond completed construction unless approved in writing by the Contract Administrator. In addition, the following actions must be taken as pioneering progresses:

- Drainage must be provided on all uncompleted construction.
- Road pioneering operations may not undercut the final cut slope or restrict drainage.
- Culverts at live stream crossings must be installed during pioneering operations prior to embankment.

**4-3 ROAD GRADE AND ALIGNMENT STANDARDS**

Purchaser shall follow these standards for road grade and alignment except as designed:

- Grade and alignment must have smooth continuity, without abrupt changes in direction.
- Maximum grades may not exceed 18 percent favorable and 12 percent adverse.
- Minimum curve radius is 50 feet at centerline.
- Maximum grade change for sag vertical curves is 5% in 100 feet.
- Maximum grade change for crest vertical curves is 4% in 100 feet.

**4-5 CUT SLOPE RATIO**

Purchaser shall construct excavation slopes no steeper than shown on the following table:

<u>Material Type</u>	<u>Excavation Slope Ratio</u>	<u>Excavation Slope Percent</u>
Common Earth (on side slopes up to 55%)	1:1	100
Fractured or loose rock	½:1	200
Hardpan or solid rock	¼:1	400

**4-6 EMBANKMENT SLOPE RATIO**

Purchaser shall construct embankment slopes no steeper than shown on the following table:

<u>Material Type</u>	<u>Embankment Slope Ratio</u>	<u>Embankment Slope Percent</u>
Sandy Soils	2:1	50
Common Earth and Rounded Gravel	1½:1	67
Angular Rock	1¼:1	80

**4-7 SHAPING CUT AND FILL SLOPE**

Purchaser shall construct excavation and embankment slopes to a uniform line and left rough for easier revegetation.

**4-8 CURVE WIDENING**

The minimum widening placed on the inside of curves is:

- 6 feet for curves of 50 to 79 feet radius.
- 4 feet for curves of 80 to 100 feet radius.

#### **4-9 EMBANKMENT WIDENING**

The minimum embankment widening is:

- 2 feet for embankment heights at centerline of 2 to 6 feet.
- 4 feet for embankment heights at centerline of greater than 6 feet.

Purchaser shall apply embankment widening equally to both sides of the road to achieve the required width.

#### **4-25 DITCH CONSTRUCTION AND RECONSTRUCTION**

Purchaser shall construct ditches into the subgrade as specified on the TYPICAL SECTION SHEET. Ditches must be constructed concurrently with construction of the subgrade.

#### **4-28 DITCH DRAINAGE**

Ditches must drain to cross-drain culverts or ditchouts.

#### **4-29 DITCHOUTS**

Purchaser shall construct ditchouts as needed and as directed by the Contract Administrator. Ditchouts must be constructed in a manner that diverts ditch water onto the forest floor and must have excavation backslopes no steeper than a 1:1 ratio.

#### **4-35 WASTE MATERIAL DEFINITION**

Waste material is defined as all dirt, rock, mud, or related material that is extraneous or unsuitable for construction material. Waste material, as used in Section 4 EXCAVATION, is not organic debris.

#### **4-36 DISPOSAL OF WASTE MATERIAL**

Purchaser may sidecast waste material on side slopes up to 60% if the waste material is compacted and free of organic debris. On side slopes greater than 60%, all waste material must be end hauled or pushed to the designated embankment sites and waste areas identified in Clause 4-37 WASTE AREA LOCATION.

#### **4-37 WASTE AREA LOCATION**

Purchaser shall deposit waste material in areas identified or approved by the Contract Administrator. The amount of material allowed in a waste area is at the discretion of the Contract Administrator.

**4-38 PROHIBITED WASTE DISPOSAL AREAS**

Purchaser shall not deposit waste material in the following areas, except as otherwise specified in this plan:

- Within 50 feet of a cross drain culvert.
- Within 100 feet of a live stream or wetland.
- In locations that interfere with the construction of the road prism.
- In locations that impede drainage.
- Against standing timber.
- Outside the clearing limits.

**4-55 ROAD SHAPING**

Purchaser shall shape the subgrade and surface as shown on the TYPICAL SECTION SHEET. The subgrade and surface shape must ensure runoff in an even, un-concentrated manner, and must be uniform, firm, and rut-free.

**4-60 FILL COMPACTION**

Purchaser shall compact all embankment and waste material by routing equipment over the entire width of each lift.

**4-61 SUBGRADE COMPACTION**

Purchaser shall compact constructed and reconstructed subgrades by routing equipment over the entire width.

SECTION 5 – DRAINAGE

**5-5 CULVERTS**

Purchaser shall install culverts as part of this contract. Culverts must be installed concurrently with subgrade work and must be installed before subgrade compaction and rock application. Culvert locations and the minimum requirements for culvert length and diameter are designated on MATERIALS LIST. Culvert, downspout, and flume lengths may be adjusted to fit as-built conditions and may not terminate directly on unprotected soil. Culverts may be new or used material and must meet the specifications in Clauses 10-15 through 10-24.

**5-7 USED CULVERT MATERIAL**

On the following road, Purchaser may install used culverts. All other roads must have new culverts installed. Purchaser shall obtain approval from the Contract Administrator for the quality of the used culverts before installation. Culverts must meet the specifications in Clauses 10-15 through 10-24.

<u>Road</u>	<u>Stations</u>
CT-06	0+00 to 3+85

**5-12 UNUSED MATERIALS STATE PROPERTY**

On required roads, any materials listed on the MATERIALS LIST that are not installed will become the property of the state. Purchaser shall stockpile materials as directed by the Contract Administrator.

**5-15 CULVERT INSTALLATION**

Culvert installation must be in accordance with the CULVERT AND DRAINAGE SPECIFICATION DETAIL and the National Corrugated Metal Pipe Association's "Installation Manual for Corrugated Steel Drainage Structures" the Corrugated Polyethylene Pipe Association's "Recommended Installation Practices for Corrugated Polyethylene Pipe and Fittings". Corrugated Polyethylene pipe must be installed in a manner consistent with the manufacturer's recommendations.

**5-17 CROSS DRAIN SKEW AND SLOPE**

Cross drains, on road grades in excess of 3%, must be skewed at least 30 degrees from perpendicular to the road centerline, except where the cross drain is at the low point in the road culverts will not be skewed. Cross drain culverts must be installed at a slope steeper than the incoming ditch grade, but not less than 3% or more than 10%.

**5-18 CULVERT DEPTH OF COVER**

Cross drain culverts must be installed with a depth of cover of not less than 1 foot of compacted subgrade over the top of the culvert at the shallowest point. Stream crossing culverts must be installed with a depth of cover recommended by the culvert manufacturer for the type and size of the pipe.

**5-20 ENERGY DISSIPATERS**

Purchaser shall install energy dissipaters in accordance with the CULVERT AND DRAINAGE SPECIFICATION DETAIL at all cross drain culverts, Energy dissipater installation is subject to approval by the Contract Administrator.

Rock used for energy dissipaters must be light/loose riprap. Energy dissipaters must extend a minimum of 1 foot to each side of the culvert at the outlet and a minimum of 2 feet beyond the outlet. Rock must be set in place by machine. Placement must be by zero-drop-height method only. No placement by end dumping or dropping of rock is allowed. Rock type shall meet the specifications in Clause 6-50 LIGHT LOOSE RIP RAP.

**5-25 CATCH BASINS**

Purchaser shall construct catch basins in accordance with CULVERT AND DRAINAGE SPECIFICATION DETAIL. Minimum dimensions of catch basins are 2 feet wide and 4 feet long.



**5-26 HEADWALLS FOR CROSS DRAIN CULVERTS**

Purchaser shall construct headwalls in accordance with the CULVERT AND DRAINAGE SPECIFICATION DETAIL at all cross drain culverts. Rock used for headwalls must weigh at least 50 pounds. Rock must be placed on shoulders, slopes, and around culvert inlets and outlets. Rock may not restrict the flow of water into culvert inlets or catch basins. No placement by end dumping or dropping of rock is allowed.

SECTION 6 – ROCK AND SURFACING

**6-3 ROCK SOURCE STATE LAND, EXISTING STOCKPILE**

Rock used in accordance with the quantities on the TYPICAL SECTION and MATERIALS LIST may be obtained from the following existing stockpile on state land at no charge to the Purchaser. Other stockpiles may not be used without prior written approval from the Contract Administrator.

<u>Source</u>	<u>Location</u>	<u>Rock Type</u>	<u>Quantity</u>
Christie Pit Stockpile	Station 182+65 of the CT-ML	3-inch-minus ballast rock	All available rock

**6-5 ROCK FROM COMMERCIAL SOURCE**

Rock used in accordance with the quantities on the TYPICAL SECTION and MATERIALS LIST may be obtained from any commercial source at the Purchaser's expense. Rock sources are subject to written approval by the Contract Administrator before their use.

**6-23 ROCK GRADATION TYPES**

Purchaser shall provide rock in accordance with the types and amounts listed in the TYPICAL SECTION and MATERIALS LIST. Rock must meet the following specifications for gradation and uniform quality when placed in hauling vehicles or during manufacture and placement into a stockpile. The exact point of evaluation for conformance to specifications will be determined by the Contract Administrator.

**6-34 3-INCH MINUS BALLAST ROCK**

Ballast rock must be 100% equal to, or smaller than, 3 inches in at least one dimension.

Rock may contain no more than 5 percent organic debris, dirt, and trash. All percentages are by weight.

**6-50 LIGHT LOOSE RIP RAP**

Rip rap must consist of angular, hard, sound, and durable stone. It must be free from segregation, seams, cracks, and other defects. Light loose rip rap must be free of rock fines, soil, organic debris or other extraneous material, and must meet the following requirements:

<u>At Least/Not More Than</u>	<u>Weight Range</u>
20% / 90%	300 lbs. to 1 ton
80% / --	50 lbs. to ½ ton
10% / 20%	50 lbs. max

**6-55 ROCK APPLICATION MEASURED BY COMPACTED DEPTH**

Measurement of specified rock depths, are defined as the compacted depths using the compaction methods required in this road plan. Estimated quantities specified in the TYPICAL SECTION are loose yards. Purchaser shall apply adequate amounts of rock to meet the specified rock depths. Specified rock depths are minimum requirements, and are not subject to reduction.

**6-70 APPROVAL BEFORE ROCK APPLICATION**

Purchaser shall obtain written approval from the Contract Administrator for culvert installation, ditch construction, ditch reconstruction, headwall construction, headwall reconstruction, subgrade shape, and compaction before rock application.

**6-71 ROCK APPLICATION**

Purchaser shall apply rock in accordance with the specifications and quantities shown on the TYPICAL SECTION. Rock must be spread, shaped, and compacted full width concurrent with rock hauling operations. Road surfaces must be compacted in accordance with the TYPICAL SECTION by routing equipment over the entire width.

**6-73 ROCK FOR WIDENED PORTIONS**

Purchaser shall apply rock to turnarounds, turnouts, and areas with curve widening to the same depth and specifications as the traveled way.

SECTION 8 – EROSION CONTROL

**8-2 PROTECTION FOR EXPOSED SOIL**

Purchaser shall provide and evenly spread a 4-inch layer of straw to all exposed soils within 50 feet of a stream or wetland. Soils must be covered before the first anticipated storm event.

**8-15 REVEGETATION**

Purchaser shall spread seed and fertilizer on all exposed soils within the grubbing limits resulting from road work activities. Cover all exposed soils using manual dispersal of grass seed and fertilizer. Other methods of covering must be approved in writing by the Contract Administrator.

**8-16 REVEGETATION SUPPLY**

The Purchaser shall provide the required grass seed and fertilizer.

**8-17 REVEGETATION TIMING**

Purchaser shall revegetate during the first available opportunity after road work is completed. Soils may not be allowed to sit exposed for longer than one month without receiving revegetation treatment unless otherwise approved in writing by the Contract Administrator.

**8-18 PROTECTION FOR SEED**

Purchaser shall provide a protective cover for seed if revegetation occurs between July 1 and March 31. The protective cover may consist of dispersed straw, jute matting, or clear plastic sheets. The protective cover requirement may be waived in writing by the Contract Administrator if Purchaser is able to demonstrate a revegetation plan that will result in the establishment of a uniform dense crop (at least 50% coverage) of 3-inch tall grass by October 31.

**8-19 ASSURANCE FOR SEEDED AREA**

Purchaser shall ensure the growth of a uniform and dense crop (at least 50% coverage) of 3-inch tall grass. Purchaser shall reapply the grass seed and fertilizer in areas that have failed to germinate or have been damaged through any cause. Restore eroded or disturbed areas, clean up and properly dispose of eroded materials, and reapply the seed and fertilizer at no addition cost to the state.

**8-25 GRASS SEED**

Purchaser shall evenly spread the seed mixture listed below on all exposed soil inside the grubbing limits at a rate of 50 pounds per acre of exposed soil. Grass seed must meet the following specifications:

1. Weed seed may not exceed 0.5% by weight.
2. All seed species must have a minimum 90% germination rate, unless otherwise specified.
3. Seed must be certified.
4. Seed must be furnished in standard containers showing the following information:
  - a. Common name of seed
  - b. Net weight
  - c. Percent of purity
  - d. Percentage of germination
  - e. Percentage of weed seed and inert material
5. Seed must conform to the following mixture.

<u>Kind and Variety of Seed in Mixture</u>	<u>% by Weight</u>
Creeping Red Fescue	50
Elf Perennial Rye Grass	25
Highland Colonial Bentgrass	15
White Clover	10
Inert and Other Crop	0.5

**8-27 FERTILIZER**

Purchaser shall evenly spread the fertilizer listed below on all exposed soil inside the grubbing limits at a rate of 200 pounds per acre of exposed soil. Fertilizer must meet the following specifications:

<u>Chemical Component</u>	<u>% by Weight</u>
Nitrogen	16
Phosphorous	16
Potassium	16
Sulphur	3
Inerts	49

SECTION 9 – POST-HAUL ROAD WORK

**9-3 CULVERT MATERIAL REMOVED FROM STATE LAND**

Culverts removed from roads become the property of the Purchaser and must be removed from state land.

**9-5 POST-HAUL MAINTENANCE**

Purchaser shall perform post-haul maintenance in accordance with the FOREST ACCESS ROAD MAINTENANCE SPECIFICATIONS.

**9-10 LANDING DRAINAGE**

Purchaser shall provide for drainage of the landing surface.

**9-12 LANDING EMBANKMENT REMOVAL**

Purchaser shall reduce or relocate the landing embankment. Place excavated material in a waste area approved in writing by the Contract Administrator.

**9-21 ROAD ABANDONMENT**

Purchaser shall abandon the following before the termination of this contract.

<u>Road</u>	<u>Stations</u>
CT-06	0+00 to 3+85

## **9-22 ABANDONMENT**

- Remove all ditch relief culverts. The resulting slopes must be 1:1 or flatter. Place and compact the removed fill material in a location that will not erode into any Type 1 through 5 waters or wetlands.
- Remove all culverts in natural drainages. The resulting slopes must be 1½:1 or flatter. Strive to match the existing native stream bank gradient. The natural streambed width must be re-established. Place and compact the removed fill material in a location that will not erode into any Type 1 through 5 waters or wetlands.
- Transport all removed culverts off site. All removed culverts are the property of the Purchaser.
- Construct non-drivable waterbars at natural drainage points and at a spacing that will produce a vertical drop of no more than 20 feet between waterbars and with a maximum horizontal spacing of 400 feet.
- Skew waterbars at least 30 degrees from perpendicular to the road centerline on roads in excess of 3 percent grade.
- Key waterbars into the cut-slope to intercept the ditch. Waterbars must be outsloped to provide positive drainage. Outlets must be on stable locations.
- Inslope or outslope the road as appropriate.
- Remove bridges and other structures.
- Pull back unstable fill that has potential of failing and entering any Type 1 through 5 waters or wetlands. Place and compact removed material in a stable location.
- Remove berms except as designed.
- Block the road by constructing an aggressive barrier of dense interlocked large woody debris (logs, stumps, root wads, etc.) so that four wheel highway vehicles cannot pass the point of abandonment. Typical barrier dimensions are 10 feet high by 20 feet deep, spanning the entire road prism from top of cutslope to toe of fillslope. Long term effectiveness is the primary objective. If necessary construct a vehicular turn-around near the point of abandonment.
- Apply grass seed to all exposed soils resulting from the abandonment work and in accordance with Section 8 EROSION CONTROL

## **SECTION 10 MATERIALS**

### **10-15 CORRUGATED STEEL CULVERT**

Metallic coated steel culverts must meet AASHTO M-36 (ASTM A-760) specifications. Culverts must be galvanized (zinc coated meeting AASHTO M-218).

### **10-17 CORRUGATED PLASTIC CULVERT**

Polyethylene culverts must meet AASHTO M-294 specifications, or ASTM F-2648 specifications for recycled polyethylene. Culverts must be Type S – double walled with a corrugated exterior and smooth interior.

**10-21 METAL BAND**

Metal coupling and end bands must meet the AASHTO specification designated for the culvert and must have matching corrugations. Culverts 24 inches and smaller must have bands with a minimum width of 12 inches. Culverts over 24 inches must have bands with a minimum width of 24 inches.

**10-22 PLASTIC BAND**

Plastic coupling and end bands must meet the AASHTO specification designated for the culvert. Only fittings supplied or recommended by the culvert manufacturer may be used.

**10-23 RUBBER CULVERT GASKETS**

Rubber gaskets must be continuous closed cell, synthetic expanded rubber gaskets conforming to the requirements of ASTM D 1056. Rubber gaskets must be used with all corrugated metal pipe coupling bands.

**10-24 GAUGE AND CORRUGATION**

Metal culverts must conform to the following specifications for gage and corrugation as a function of diameter.

<u>Diameter</u>	<u>Gage</u>	<u>Corrugation</u>
18"	16 (0.064")	2 2/3" X 1/2"

ROAD #		CT-ML	CT-03	CT-06
REQUIRED / OPTIONAL		REQUIRED	REQUIRED	OPTIONAL
CONSTRUCT / RECONSTRUCT		PRE-HAUL	CONSTRUCT	CONSTRUCT
TOLERANCE CLASS (A/B/C)		A	C	C
STATION / MP TO		0+00	0+00	0+00
STATION / MP		182+65	3+65	3+85
ROAD WIDTH	R	12	12	12
CROWN (INCHES @ C/L)		3	3	3
DITCH WIDTH	W	3	3	2
DITCH DEPTH	D	1	1	1
TURNOUT LENGTH	L	-	-	-
TURNOUT WIDTH	T	-	-	-
TURNOUT TAPER	P	-	-	-
GRUBBING	G1	-	5	5
	G2	-	5	5
CLEARING	C1	-	10	10
	C2	-	10	10
ROCK FILLSLOPE	K:1	-	1½	1½
❖ BALLAST DEPTH	B1	-	12	12
CUBIC YARDS / STATION		-	72	72
➤ TOTAL CY BALLAST		-	260	275
❖ SURFACING DEPTH	B2	-	-	-
CUBIC YARDS / STATION		-	-	-
➤ TOTAL CY SURFACING		-	-	-
➤ TOTAL CUBIC YARDS		-	260	275
SUBGRADE WIDTH	S	-	15	15
BRUSHCUT (Y/N)		N	N	N
BLADE, SHAPE, & DITCH (Y/N)		Y	N	N

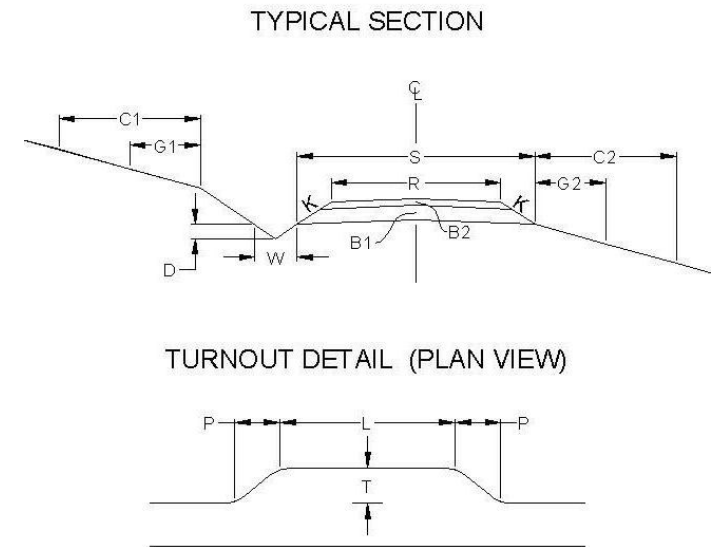

### **SYMBOL NOTES**

- ❖ Specified Rock Depth is FINISHED COMPACTED DEPTH in inches.
- Specified Rock Quantity is LOOSE MEASURE (Truck Cubic Yards) needed to accomplish specified FINISHED COMPACTED DEPTH. Rock quantities include volume for turnouts, curve widening and landings.

#### Rock Totals Summary

Type	Quantity (Cubic Yards)
Ballast	535
Rip Rap	10





## FOREST ACCESS ROAD MAINTENANCE SPECIFICATIONS

### Cuts and Fills

- Maintain slope lines to a stable gradient compatible with the construction materials. Remove slides from ditches and the roadway. Repair fill-failures, in accordance with Clause 4-6 EMBANKMENT SLOPE RATIO, with selected material or material approved by the Contract Administrator. Remove overhanging material from the top of cut slopes.
- Waste material from slides or other sources shall be placed and compacted in stable locations identified in the road plan or approved by the Contract Administrator, so that sediment will not deliver to any streams or wetlands.
- Slide material and debris shall not be mixed into the road surface materials, unless approved by the Contract Administrator.

### Surface

- Grade and shape the road surface, turnouts, and shoulders to the original shape on the TYPICAL SECTION SHEET. Inslope or outslope as directed to provide a smooth, rut-free traveled surface and maintain surface water runoff in an even, unconcentrated manner.
- Blading shall not undercut the backslope or cut into geotextile fabric on the road.
- If required by the Contract Administrator, water shall be applied as necessary to control dust and retain fine surface rock.
- Surface material shall not be bladed off the roadway. Replace surface material when lost or worn away, or as directed by the Contract Administrator.
- Remove shoulder berms, created by grading, to facilitate drainage, except as marked or directed by the Contract Administrator.
- For roads with geotextile fabric: spread surface aggregate to fill in soft spots and wheel ruts (barrel spread) to prevent damage to the geotextile fabric.

### Drainage

- Prevent silt bearing road surface and ditch runoff from delivering sediment to any streams or wetlands.
- Maintain rolling dips and drivable waterbars as needed to keep them functioning as intended.
- Maintain headwalls to the road shoulder level with material that will resist erosion.
- Maintain energy dissipaters at culvert outlets with non-erodible material or rock.
- Keep ditches, culverts, and other drainage structures clear of obstructions and functioning as intended.
- Inspect and clean culverts at least monthly, with additional inspections during storms and periods of high runoff. This shall be done even during periods of inactivity.

### Preventative Maintenance

- Perform preventative maintenance work to safeguard against storm damage, such as blading to ensure correct runoff, ditch and culvert cleaning, and waterbar maintenance.

**Termination of Use or End of Season**

- At the conclusion of logging operations, ensure all conditions of these specifications have been met.

**Debris**

Remove fallen timber, limbs, and stumps from the slopes, roadway, ditchlines, and culvert inlets.

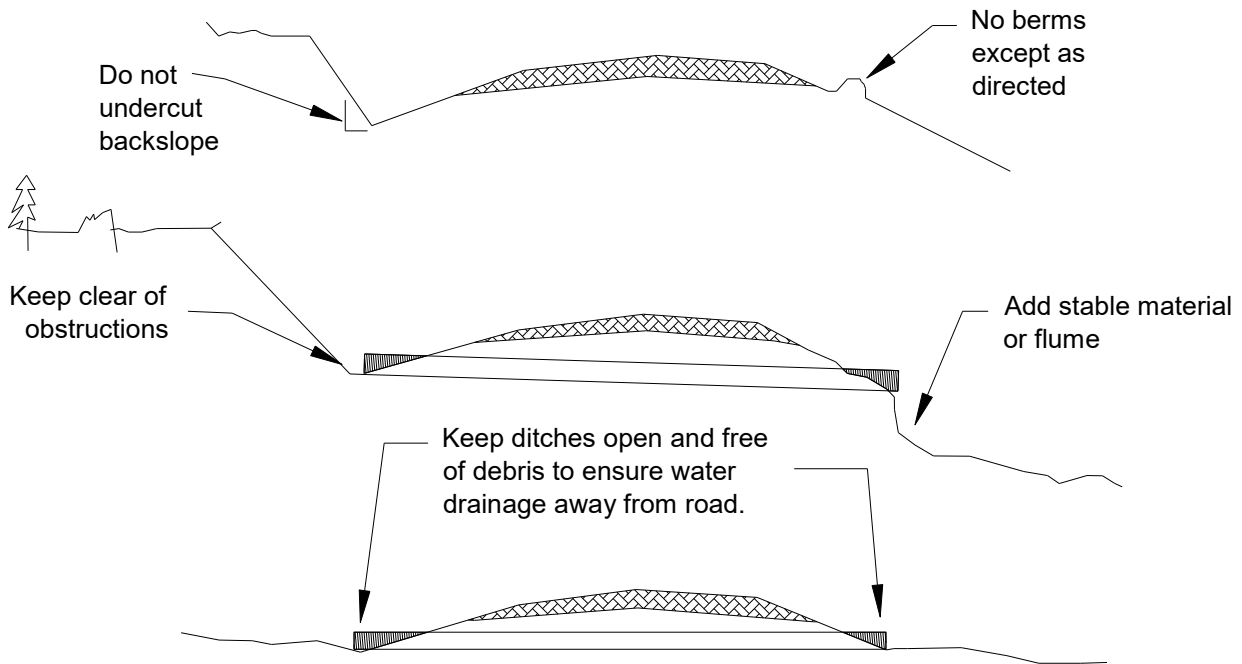

# CULVERT AND DRAINAGE SPECIFICATIONS

**CULVERT INSTALLATION (TYPICAL)**

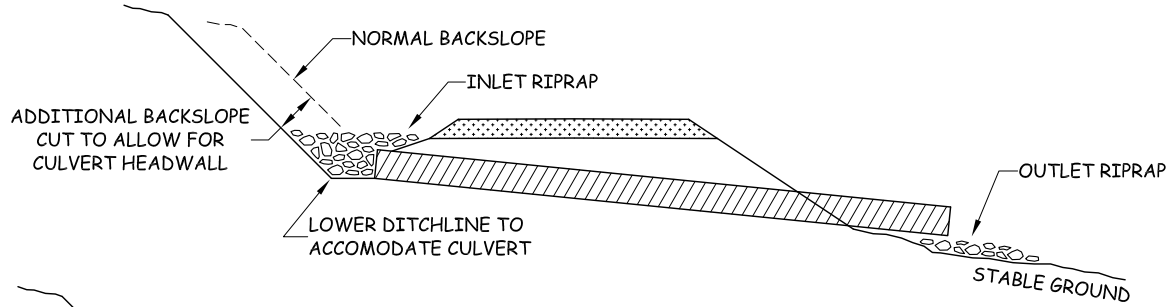

**CULVERT HEADWALL - SECTION VIEW**

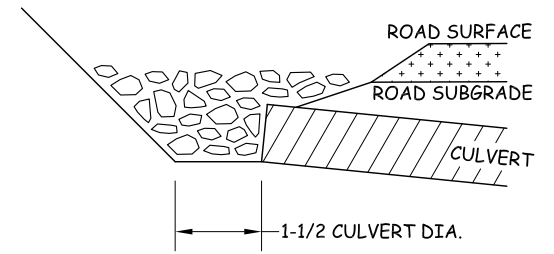

**CULVERT INSTALLATION WITH DOWNSPOUT**

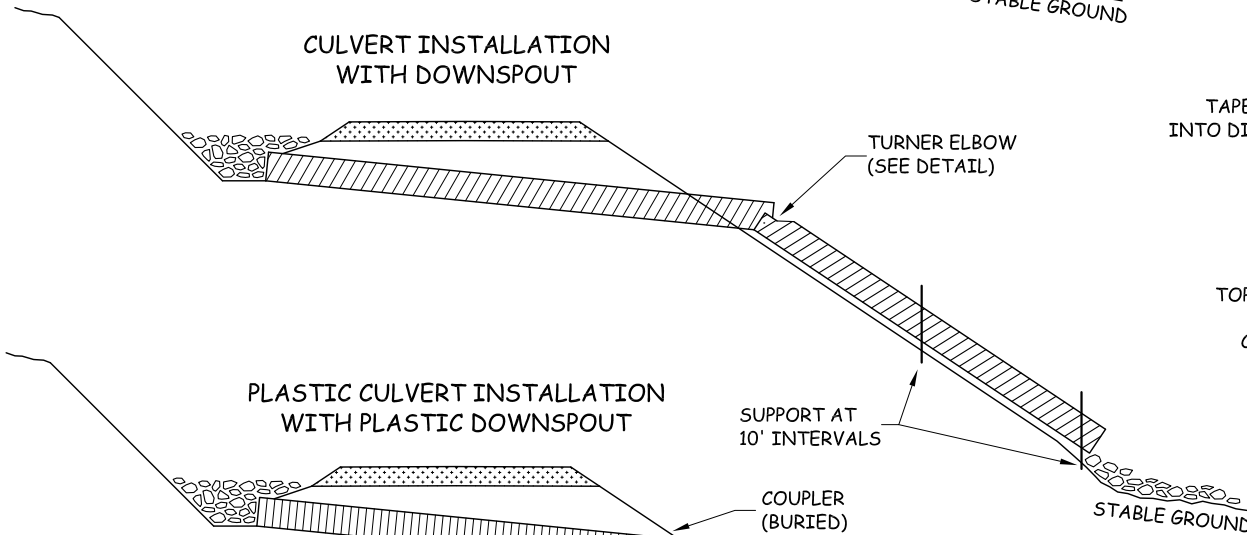

**CULVERT HEADWALL - PLAN VIEW**

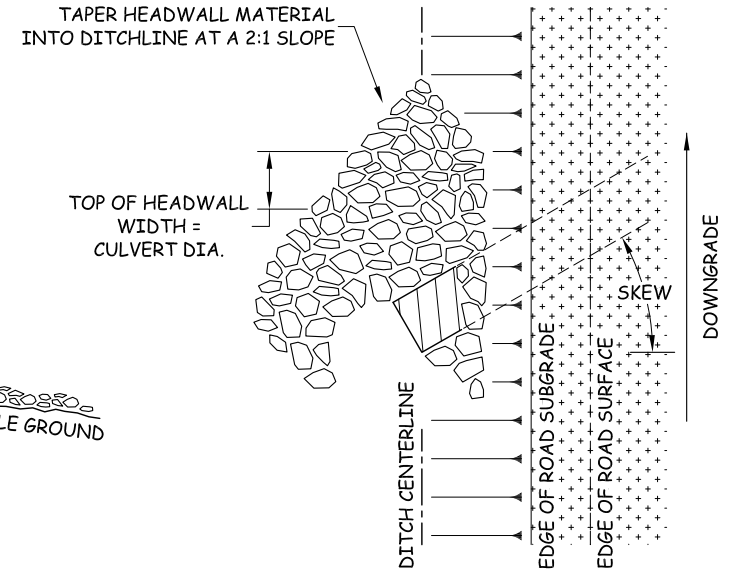

**PLASTIC CULVERT INSTALLATION WITH PLASTIC DOWNSPOUT**

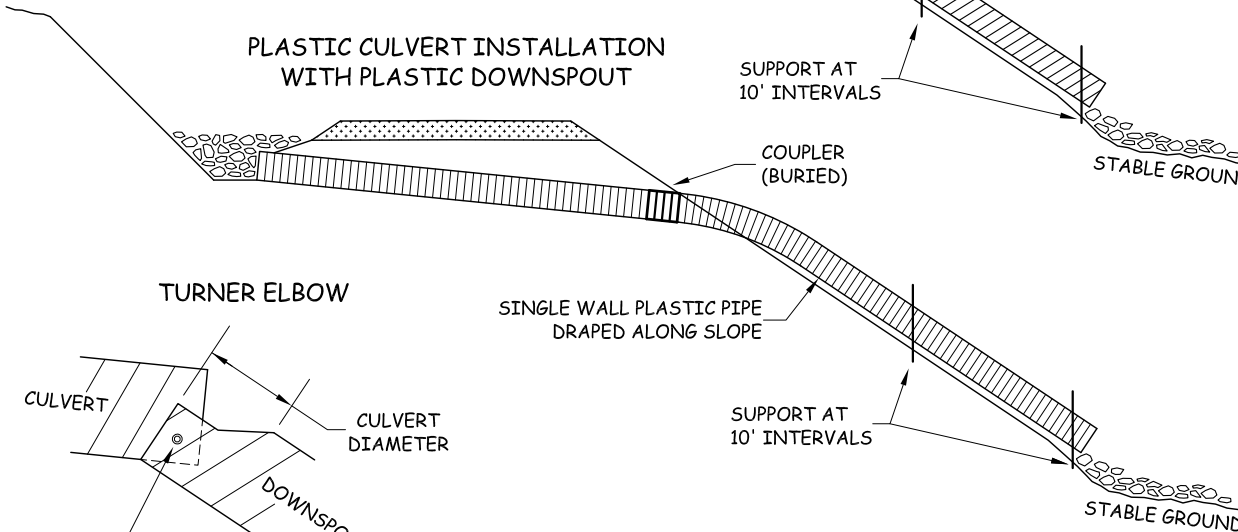

**TURNER ELBOW**

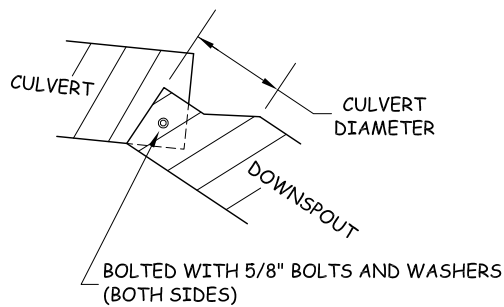

**HEADWALL NOTE:**  
 HEADWALL TO BE CONSTRUCTED OF IMPERVIOUS MATERIAL THAT WILL RESIST EROSION AND ARMORED WITH RIPRAP QUANTITY SPECIFIED IN ROAD PLAN.

CONTRACT #	PROJECT	SHEET
30-104583	EXTRA CHRISTIE	25 OF 25

## ROAD COST SUMMARY

EXTRA CHRISTIE Timber Sale #30-104583

### CONSTRUCTION SUMMARY

ROAD #	STATIONING	TOTAL STATIONS	ROCK PRODUCTION COST	ROCK LOADING COST	ROCK HAUL COST	ROCK SPREADING COST	CONSTRUCTION COST	CULVERT COST	OTHER COST	TOTAL COST	COST/STA
CT-03	0+00 to 3+65	3.65	\$0	\$1,221	\$3,279	\$1,380	\$2,490	\$455	\$146	\$8,971	\$2,458
CT-06	0+00 to 3+85	3.85	\$0	\$1,290	\$3,465	\$1,458	\$2,490	\$600	\$154	\$9,457	\$2,456
									<b>TOTAL</b>	<b>\$18,429</b>	

CONSTRUCTION COSTS include, clearing and grubbing, excavation and embankment, drilling and shooting on grade, and endhaul.

OTHER COSTS include erosion control, grass seeding and fertilizer, and miscellaneous other requirements detailed in the road plan.

### PRE-HAUL MAINTENANCE SUMMARY

ROAD #	STATIONING	TOTAL STATIONS	ROCK PRODUCTION COST	ROCK LOADING COST	ROCK HAUL COST	ROCK SPREADING COST	CULVERT COST	OTHER COST	PRE-HAUL GRADING AND BRUSHING	TOTAL COST	COST/STA
CT-ML	0+00 to 182+65	182.65	\$0	\$0	\$0	\$0	\$0	\$0	\$3,459	\$3,459	\$19
									<b>TOTAL</b>	<b>\$3,459</b>	

OTHER COSTS include cleaning culverts, ditches, headwalls, catch basins, culvert installation, and miscellaneous other requirements detailed in the road plan.

### POST-HAUL MAINTENANCE SUMMARY

ROAD #	STATIONING	TOTAL STATIONS	POST-HAUL GRADING COST	OTHER COST	TOTAL COST	COST/STA
CT-ML	0+00 to 182+65	182.65	\$2,767	\$0	\$2,767	\$15
CT-03	0+00 to 3+65	3.65	\$55	\$0	\$55	\$15
				<b>TOTAL</b>	<b>\$2,823</b>	

OTHER COSTS include miscellaneous other requirements detailed in the road plan.

**ROAD COST SUMMARY**

EXTRA CHRISTIE Timber Sale #30-104583

**ABANDONMENT SUMMARY**

<b>ROAD #</b>	<b>STATIONING</b>	<b>TOTAL STATIONS</b>	<b>ABANDONMENT COST</b>	<b>OTHER COST</b>	<b>TOTAL COST</b>	<b>COST/STA</b>
CT-06	0+00 to 3+85	3.85	\$1,120	\$0	\$1,120	\$291
				<b>TOTAL</b>	<b>\$1,120</b>	

OTHER COSTS include miscellaneous other requirements detailed in the road plan.

NOTE: ALL MOBILIZATION COSTS HAVE BEEN AMORTIZED IN WITH OTHER COSTS.

<b>TOTAL ROAD COST</b>	\$25,831	
<b>SALE VOLUME (MBF)</b>	700	PRE-CRUISE ESTIMATED VOLUME
<b>ROAD COST/MBF</b>	\$37	

# LOGGING PLAN MAP

**SALE NAME:** EXTRA CHRISTIE  
**AGREEMENT#:** None  
**TOWNSHIP(S):** T37R5E  
**TRUST(S):** State Forest Transfer (1)

**REGION:** Northwest Region  
**COUNTY(S):** Whatcom  
**ELEVATION RGE:** 320-520

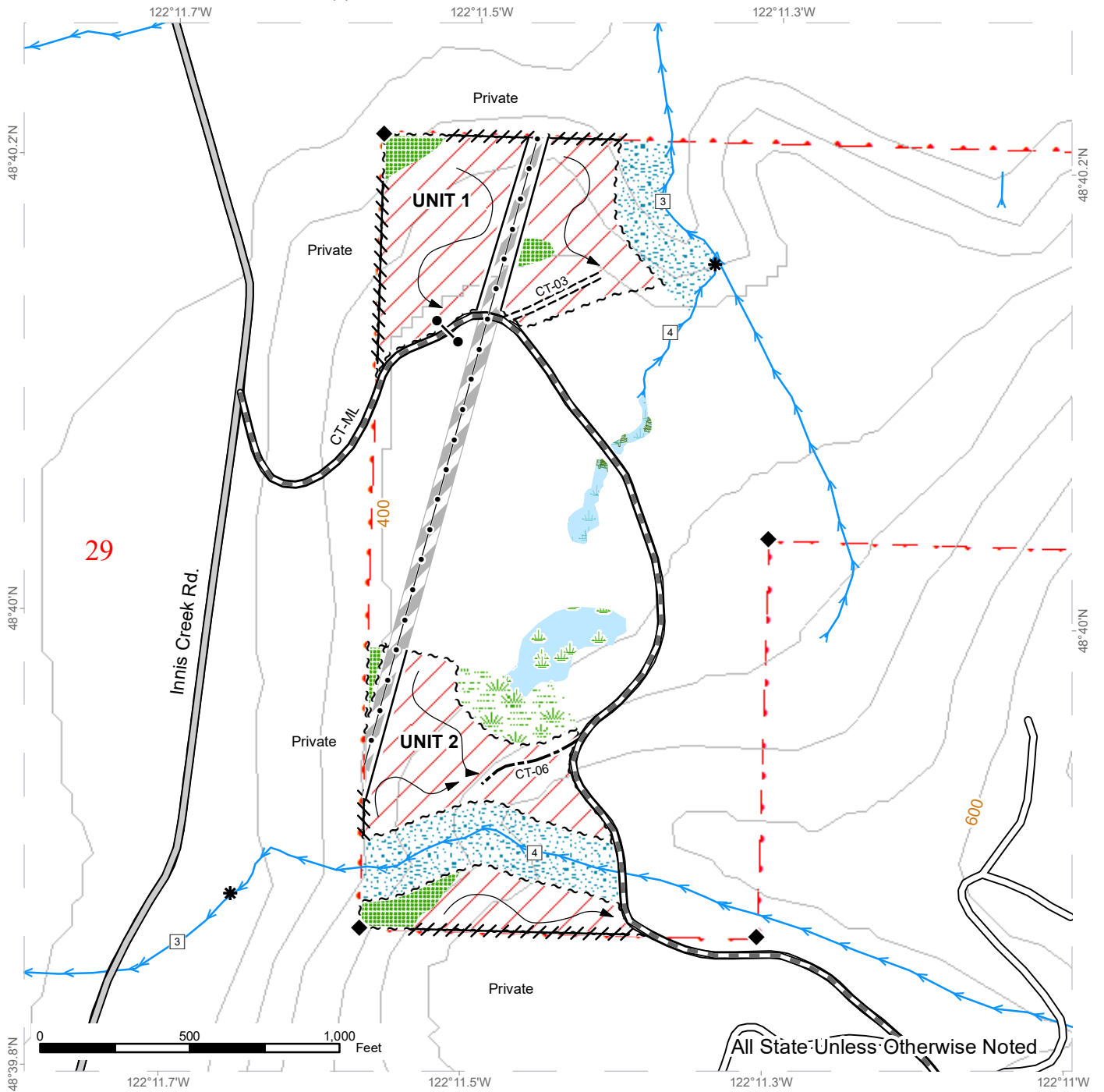

All State Unless Otherwise Noted

Sale Area	Leave Tree Area	County Road	Streams
Sale Boundary Tags	Wetlands - Non-forested	Existing Roads	Stream Type
Timber Type Change	Forested Wetland	Required Pre-Haul Maintenance	Stream Type Break
Last Take / Removal Trees	Wetland Mgt Zone	Required Construction	Survey Monument
Property Line	Riparian Mgt Zone	Optional Construction	Gate
Pipeline	Utility Right-of-Way	Ground-based Harvest	

