



TIMBER NOTICE OF SALE

SALE NAME: STAIRWAY TO HEMLOCK

AGREEMENT NO: 30-87001

AUCTION: March 28, 2024 starting at 10:00 a.m., **COUNTY:** Wahkiakum
Pacific Cascade Region Office, Castle Rock, WA

SALE LOCATION: Sale located approximately 20 miles west of Longview, WA

**PRODUCTS SOLD
AND SALE AREA:**

All timber, except leave trees bound by yellow "Leave Tree Area" tags, leave trees marked with blue paint, and all down timber existing 5 years prior to the day of sale bound by the following;

Unit 1 and 2, white "Timber Sale Boundary" tags, pink flagging, reprod and the E-5000 road;

Unit 3, white "Timber Sale Boundary" tags, pink flagging and the E-5800 road;

Unit 4, orange "Right of Way" tags, orange flagging and the E-5000 road;

All forest products above located on part(s) of Sections 13, 14, 23 and 24 all in Township 9 North, Range 5 West, W.M., containing 149 acres, more or less.

CERTIFICATION: This sale is certified under the Sustainable Forestry Initiative® program Standard (cert no: BVC-SFIFM-018227)

ESTIMATED SALE VOLUMES AND QUALITY:

Species	Avg Ring DBH Count	Total MBF	MBF by Grade								
			1P	2P	3P	SM	1S	2S	3S	4S	UT
Hemlock	18.5	7,955						4,954	2,510	417	74
Douglas fir	25.8	8 790				9		669	96	15	1
Silver fir	28.1	84						77	7		
Red alder	15.2	41						17	7	17	
Redcedar	21.5	28							26	2	
Maple	9	2									2
Sale Total		8,900									

MINIMUM BID: \$1,207,000.00 **BID METHOD:** Sealed Bids

PERFORMANCE SECURITY: \$100,000.00 **SALE TYPE:** Lump Sum

EXPIRATION DATE: October 31, 2025 **ALLOCATION:** Export Restricted

BID DEPOSIT: \$120,700.00 or Bid Bond. Said deposit shall constitute an opening bid at the appraised price.

HARVEST METHOD: Ground based equipment, Cable, and Cable-Assist. This sale is estimated to be 95 percent ground based and 5 percent cable harvest.



TIMBER NOTICE OF SALE

ROADS: 11.05 stations of required construction. 82.90 stations of optional construction. 447.76 stations of required prehaul maintenance. Rock used in accordance with the quantities on the ROCK LIST may be obtained from the 7500 Pit located in Sec 1, T9N, R5W, W.M. on state land at no charge to the Purchaser.

Rock used in accordance with the quantities on the ROCK LIST may be obtained from the 7500 Stockpile located at Station 88+00 on the 7500 road on state land at no charge to the Purchaser.

Rock used in accordance with the quantities on the ROCK LIST may be obtained from any commercial source at the Purchaser's expense. Road construction will not be permitted from October 1 to April 30 unless authorized in writing by the Contract Administrator.

ACREAGE DETERMINATION

CRUISE METHOD: The sale acres were determined by GPS. The sale area was cruised using a variable plot cruise method.

FEES: \$151,300.00 is due on day of sale. \$9.00 per MBF is due upon removal. These are in addition to the bid price.

SPECIAL REMARKS: Estimated 17 MBF HQ 3 Saw DF, 157 MBF HQ 2 Saw DF and 9 MBF Special Mill Douglas-fir along. See cruise for further details.

TIMBER SALE MAP

SALE NAME: STAIRWAY TO HEMLOCK
AGREEMENT #: 30-087001
TOWNSHIP(S): T9R5W
TRUST(S): Capitol Grant (7), Scientific School (10)

REGION: Pacific Cascade Region
COUNTY(S): Wahkiakum
ELEVATION RGE: 811-1258

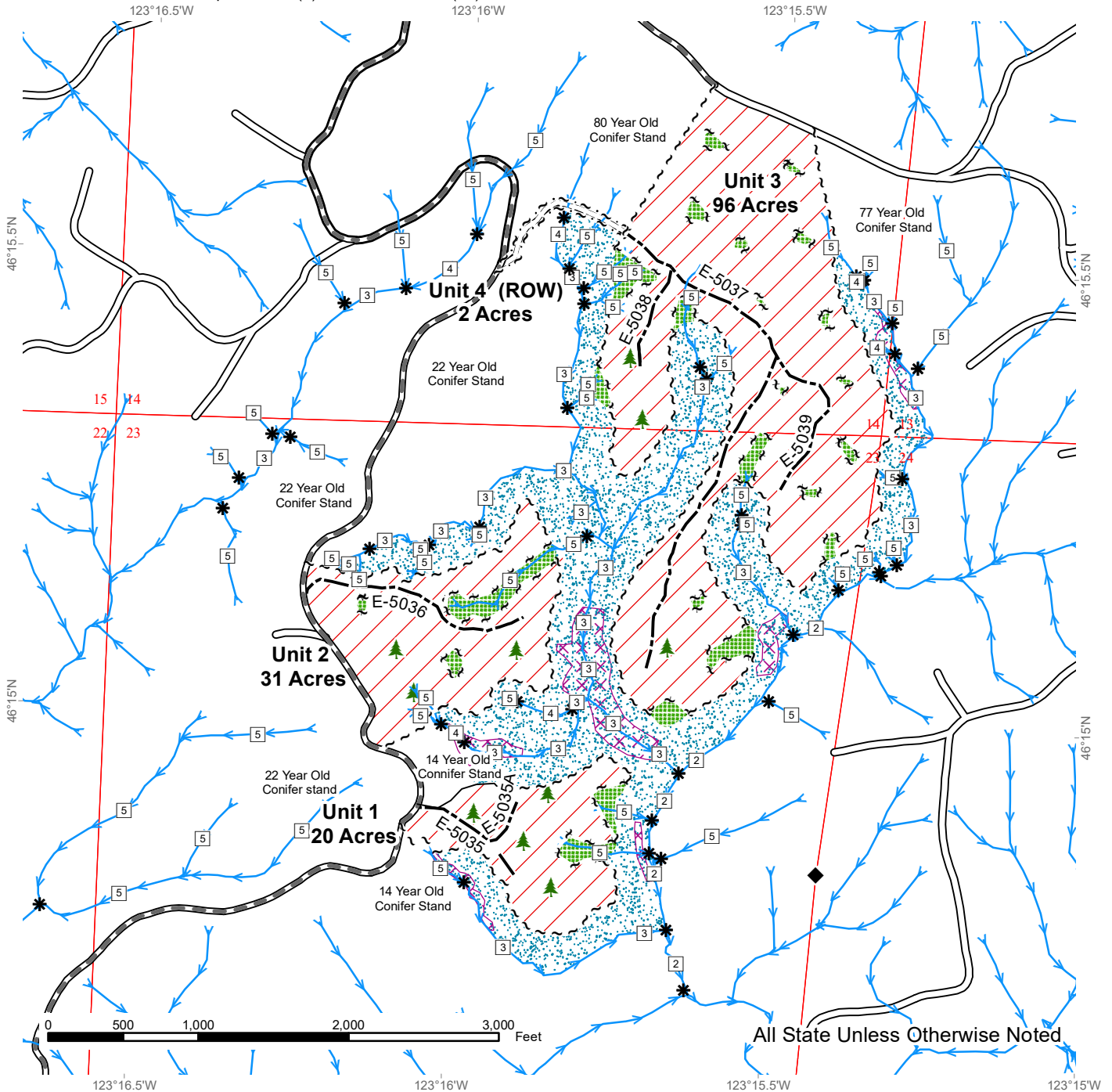

All State Unless Otherwise Noted

	Variable Retention Harvest		Sale Boundary Tags		Streams
	Leave Tree Area		Leave Tree Tags		Stream Type
	Potentially Unstable Slopes		Right of Way Tags		Stream Type Break
	Riparian Mgt Zone		Timber Type Change		Leave Tree Area <1/4-acre
			Existing Roads		
			Required Pre-Haul Maintenance		
			Required Construction		
			Optional Construction		



DRIVING MAP

SALE NAME: STAIRWAY TO HEMLOCK
AGREEMENT#: 30-087001
TOWNSHIP(S): T9R5W
TRUST(S): Capitol Grant (7), Scientific School (10)

REGION: Pacific Cascade Region
COUNTY(S): Wahkiakum
ELEVATION RGE: 811-1258

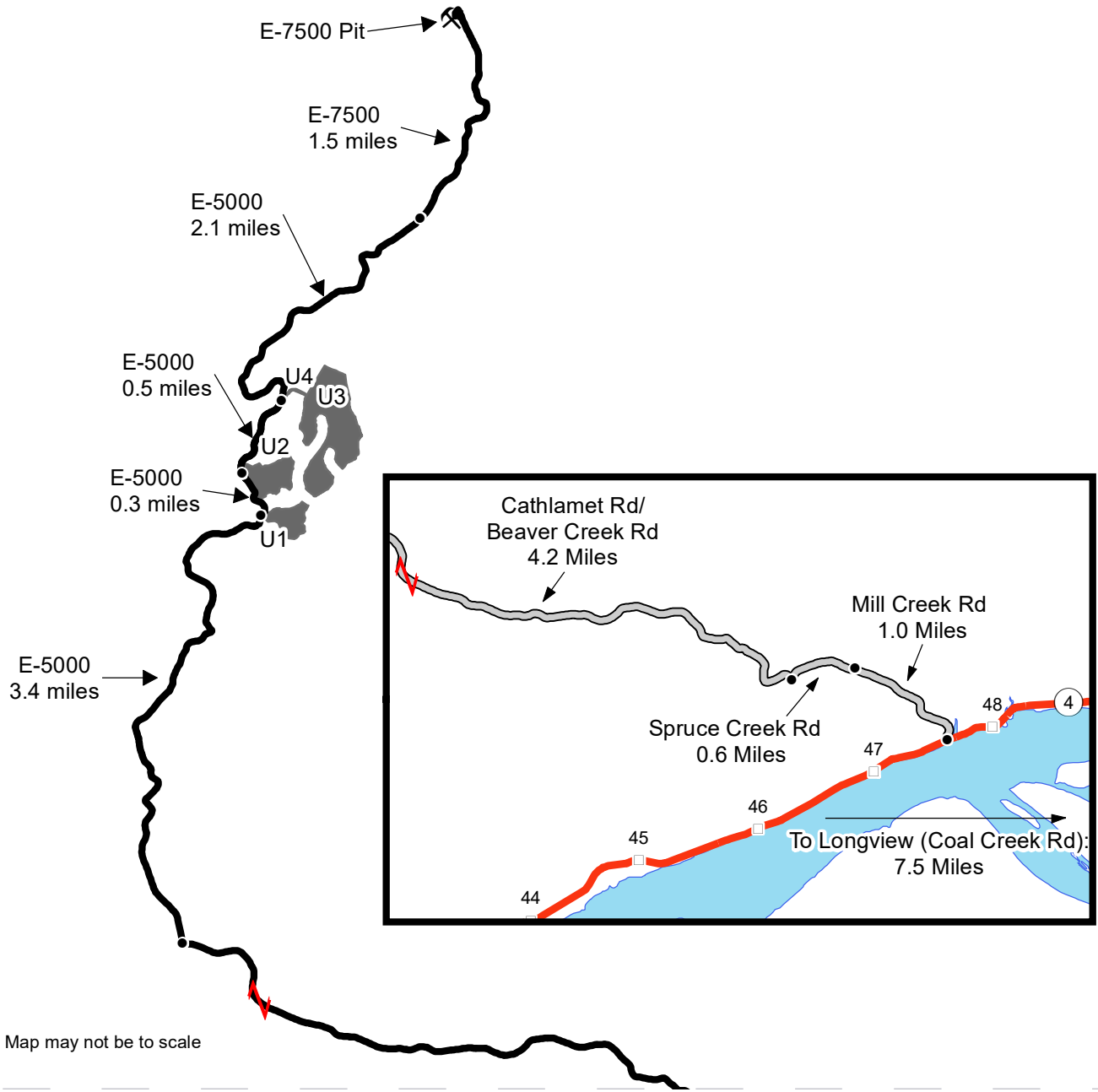

Map may not be to scale

<ul style="list-style-type: none"> Timber Sale Unit Haul Route Distance Indicator Map Continues Rock Pit Milepost Markers 	<p><u>DRIVING DIRECTIONS:</u></p> <p>From State Route 4, turn north onto Mill Creek Rd. Follow for 1.0 miles. Turn left onto Spruce Creek Rd. Follow for 0.6 miles. Turn right onto Cathlamet Rd (which soon becomes Beaver Creek Rd). Follow for 4.2 miles. Turn Right onto E-5000. Follow for 3.4 miles to reach Unit 1, 3.7 miles to reach Unit 2, and 4.2 miles to reach Units 3 and 4.</p> <p>Rock Pit Access: Turn onto the E-5000. Follow for 6.3 miles. Continue onto the E-7500. Follow for 1.5 miles.</p>
--	--



**STATE OF WASHINGTON
DEPARTMENT OF NATURAL RESOURCES**

**BILL OF SALE AND CONTRACT FOR
FOREST PRODUCTS**

Export Restricted Lump Sum AGREEMENT NO. 30-087001

SALE NAME: STAIRWAY TO HEMLOCK

**THE STATE OF WASHINGTON DEPARTMENT OF NATURAL
RESOURCES, HEREINAFTER ACTING SOLELY, IN ITS PROPRIETARY
CAPACITY, STATE, AND PURCHASER, AGREE AS FOLLOWS:**

Section G: General Terms

G-001 Definitions

The following definitions apply throughout this contract;

Bill of Sale and Contract for Forest Products: Contract between the Purchaser and the State, which sets forth the procedures and obligations of the Purchaser in exchange for the right to remove forest products from the sale area. The Bill of Sale and Contract for Forest Products may include a Road Plan for any road construction or reconstruction, where applicable.

Contract Administrator: Region Manager's designee responsible for assuring that the contractual obligations of the Purchaser are met.

Forest Product: Any material derived from the forest for commercial use.

Purchaser: The company or individual that has entered into a Bill of Sale and Contract for Forest Products with the State for the right to harvest and remove forest products from the timber sale area.

Road Construction: Includes building new and maintaining existing forest roads and associated work that may be optional or required as described in the Road Plan.

State: The Washington State Department of Natural Resources, landowner and seller of Forest Products from the timber sale area. The State is represented by the Region Manager as designated on the contract signature page. Contractual obligations to the State are enforced by the Region Manager or the designated Contract Administrator.

Subcontractor: Individual or company employed by the Purchaser to perform a portion or all of the services required by The Bill of Sale and Contract for Forest Products. The Purchaser is responsible for independently negotiating, procuring and paying for all subcontracted services rendered.

G-011 Right to Remove Forest Products and Contract Area

Purchaser was the successful bidder on March 28, 2024 and the sale was confirmed on _____. The State, as owner, agrees to sell to Purchaser, and Purchaser agrees to purchase as much of the following forest products as can be cut and removed during the term of this contract: All timber, except leave trees bound by yellow "Leave Tree Area" tags, leave trees marked with blue paint, and all down timber existing 5 years prior to the day of sale bound by the following;

Unit 1 and 2, white "Timber Sale Boundary" tags, pink flagging, reprod and the E-5000 road;

Unit 3, white "Timber Sale Boundary" tags, pink flagging and the E-5800 road;

Unit 4, orange "Right of Way" tags, orange flagging and the E-5000 road;

All forest products described above located on approximately 149 acres on part(s) of Sections 13, 14, 23, and 24 all in Township 9 North, Range 5 West W.M. in Wahkiakum County(s) as designated on the sale area and as shown on the attached timber sale map.

All forest products described above from the bole of the tree that meet or exceed 2 inches diameter inside bark on the small end are eligible for removal. Above ground components of a tree that remain as by-products after the manufacture of logs, including but not limited to tree tops, branches, limbs, needles, leaves, stumps, are not eligible for removal under the terms of this contract.

Forest products purchased under a contract that is designated as export restricted shall not be exported until processed. Forest products purchased under a contract that is designated as exportable may be exported prior to processing.

G-020 Inspection By Purchaser

Purchaser hereby warrants to the State that they have had an opportunity to fully inspect the sale area and the forest products being sold. Purchaser further warrants to the State that they enter this contract based solely upon their own judgment of the value

of the forest products, formed after their own examination and inspection of both the timber sale area and the forest products being sold. Purchaser also warrants to the State that they enter this contract without any reliance upon the volume estimates, acreage estimates, appraisals, pre-bid documentation, or any other representations by the State Department of Natural Resources.

G-031 Contract Term

Purchaser shall complete all work required by this contract prior to October 31, 2025.

G-040 Contract Term Adjustment - No Payment

Purchaser may request an adjustment in the contract term. A claim must be submitted in writing and received by the State within 30 days after the start of interruption or delay. The claim must also indicate the actual or anticipated length of interruption or delay. The State may grant an adjustment without charge only if the cause for contract term adjustment is beyond Purchaser's control. The cause must be one of the following and the adjustment may be granted only if operations or planned operations under this contract are actually interrupted or delayed:

- a. Road and bridge failures which deny access.
- b. Access road closures imposed by road owner.
- c. Excessive suspensions as provided in clause G-220.
- d. Regulatory actions not arising from Purchaser's failure to comply with this contract which will prevent timber harvest for a period less than 6 months.

G-051 Contract Term Extension - Payment

Extensions of this contract term may be granted only if, in the judgment of the State, Purchaser is acting in good faith and is endeavoring to remove the forest products conveyed. The term of this contract may be extended for a reasonable time by the State if all of the following conditions are satisfied:

- a. A written request for extension of the contract term must be received prior to the expiration date of the contract.
- b. Completion of all required roads and compliance with all contract and regulatory requirements.
- c. For the first extension, not to exceed 1 year, payment of at least 25 percent of the total contract price.

For the second extension, not to exceed 1 year, payment of at least 90 percent of the total contract price.

The payments shall not include the initial deposit which shall be held according to the provisions of RCW 79.15.100.

- d. Payment of an amount based on 12 percent interest per annum on the unpaid portion of the total contract price.

All payments, except the initial deposit, will be deducted from the total contract price to determine the unpaid portion of the contract.

- e. Payment of \$1,099.00 per acre per annum for the acres on which an operating release has not been issued .
- f. In no event will the extension charge be less than \$200.00.
- g. Extension payments are non-refundable.

G-053 Surveys - Sensitive, Threatened, Endangered Species

Whenever the State determines that a survey for sensitive, threatened, or endangered species is prudent, or when Purchaser determines a survey is prudent and the State agrees, Purchaser shall perform such surveys at Purchaser's expense and to the standards required by the State. The survey information shall be supplied to the State.

G-060 Exclusion of Warranties

The PARTIES AGREE that the IMPLIED WARRANTIES OF MERCHANTABILITY AND FITNESS FOR A PARTICULAR PURPOSE and ALL OTHER WARRANTIES EXPRESSED OR IMPLIED ARE EXCLUDED from this transaction and shall not apply to the goods sold. For example, THE FOLLOWING SPECIFIC MATTERS ARE NOT WARRANTED, and are EXCLUDED from this transaction:

- a. The MERCHANTABILITY of the forest products. The use of the term "merchantable" in any document is not intended to vary the foregoing.
- b. The CONDITION of the forest products. The forest products will be conveyed "AS IS."
- c. The ACREAGE contained within any sale area. Any acreage descriptions appearing in the timber notice of sale, timber sale contract, or other documents are estimates only, provided solely for administrative and identification purposes.
- d. The VOLUME, QUALITY, OR GRADE of the forest products. The State neither warrants nor limits the amount of timber to be harvested. The descriptions of the forest products to be conveyed are estimates only, made solely for administrative and identification purposes.
- e. The CORRECTNESS OF ANY SOIL OR SURFACE CONDITIONS, PRE-SALE CONSTRUCTION APPRAISALS, INVESTIGATIONS, AND ALL OTHER PRE-BID DOCUMENTS PREPARED BY OR FOR THE STATE. These documents have been prepared for the State's appraisal purposes only.

- f. THAT THE SALE AREA IS FREE FROM THREATENED OR ENDANGERED SPECIES or their habitat. The State is not responsible for any interference with forestry operations that result from the presence of any threatened or endangered species, or the presence of their habitat, within the sale area.
- g. THAT THE FORESTRY OPERATIONS to be performed under this contract WILL BE FREE FROM REGULATORY ACTIONS by governmental agencies. The State is not responsible for actions to enforce regulatory laws, such as the Washington Forest Practices Act (chapter 76.09 RCW), taken by the Department of Natural Resources or any other agency that may affect the operability of this timber sale.
- h. Items contained in any other documents prepared for or by the State.

G-061 Inadvertent Discovery of Cultural Resources

Purchaser acknowledges that cultural resources as defined in WAC 222-16-010 may exist within the timber sale area and that the existence and location of such resources may be unknown at the time this contract is executed. Purchaser has a duty to exercise due care in its operations and in the event any human skeletal remains are discovered by the Purchaser or the State during the course of operations Purchaser shall immediately halt operations and notify local law enforcement in the most expeditious manner possible then notifying the Contract Administrator. In the event cultural resources are discovered by the Purchaser or the State during the course of operations Purchaser shall immediately halt operations and notify the Contract Administrator. Any potential resources shall not be removed or disturbed. Purchaser shall resume operations as directed in writing by the Contract Administrator.

G-062 Habitat Conservation Plan

The State has entered into a Habitat Conservation Plan (HCP) with the U.S. Fish and Wildlife Service and the National Marine Fisheries Service (the Services) to address state trust land management issues relating to compliance with the Federal Endangered Species Act. The activities to be carried out under this contract are located within the State's HCP area and are subject to the terms and conditions of the HCP, and the Services' Incidental Take Permit Nos. TE812521-1 and 1168 (collectively referred to as ITP), or as amended hereafter by the Services. The ITP authorizes the incidental take of certain federally listed threatened and endangered species, as specified in the ITP conditions. All HCP materials, including the ITP, are available for review at the State's Regional Offices and the administrative headquarters in Olympia, Washington.

By signing this contract, Purchaser agrees to comply with the terms and conditions of the ITP, and the HCP, which shall become terms of this contract. The State agrees to authorize the lawful activities of the Purchaser carried out pursuant to this contract, PROVIDED the Purchaser remains in compliance with the terms and conditions of both the HCP and ITP. The requirements set forth in this contract are intended to comply with the terms and conditions of the HCP and ITP. Accordingly, non-compliance with

the terms and conditions of the HCP and ITP will render the authorization provided in this paragraph void, be deemed a breach of the contract and may subject Purchaser to liability for violation of the Endangered Species Act.

Any modifications to the contract shall be proposed in writing by Purchaser, shall continue to meet the terms and conditions of the HCP and ITP, and shall require the prior written approval of the Region Manager before taking effect.

G-063 Incidental Take Permit Notification Requirements

- a. Purchaser shall immediately notify the Contract Administrator of new locations of permit species covered by the Incidental Take Permits (ITP) that are discovered within the area covered by the State's Habitat Conservation Plan (HCP), including, but not limited to: locations of occupied murrelet habitat; spotted owl nest sites; wolves; grizzly bears; nests, communal roosts, or feeding concentrations of bald eagles; peregrine falcon nests; Columbian white-tailed deer; Aleutian Canada geese; Oregon silverspot butterflies; and additional stream reaches found to contain bull trout. Purchaser is required to notify the Contract Administrator upon discovery of any fish species found in streams or bodies of water classified as non-fish bearing. In all circumstances, notification must occur within a 24 hour time period.
- b. Upon locating any live, dead, injured, or sick specimens of any permit species covered by the ITP, Purchaser shall immediately notify the Contract Administrator. Purchaser shall notify the Contract Administrator if there is any doubt as to the identification of a discovered permit species. Purchaser may be required to take certain actions to help the Contract Administrator safeguard the well-being of any live, injured or sick specimens of any permit species discovered, until the proper disposition of such specimens can be determined by the Contract Administrator. Any such requirements will be explained to Purchaser by the Contract Administrator during the Pre-Work Conference. In all circumstances, notification must occur within a 24 hour time period.
- c. Purchaser shall refer to a specific ITP number, ITP TE812521-1 or ITP 1168 (copies which are located in the region office) in all correspondence and reports concerning permit activities.
- d. Provisions and requirements of the ITP shall be clearly presented and explained to Purchaser by Contract Administrator during the Pre-Work Conference as per contract clause G-330. All applicable provisions of the ITP and this schedule must be presented and clearly explained by Purchaser to all authorized officers, employees, contractors, or agents of Purchaser conducting authorized activities in the timber sale area. Any questions Purchaser may have about the ITP should be directed to the Contract Administrator.

G-064 Permits

Purchaser is responsible for obtaining any permits not already obtained by the State that relate to Purchaser's operation. Forest Practice Application / Hydraulic Project Approval permits obtained by the State shall be transferred to Purchaser. Purchaser is responsible for all permits, amendments and renewals.

G-065 Regulatory Disclaimer

The State disclaims any responsibility for, or liability relating to, regulatory actions by any government agency, including actions pursuant to the Forest Practices Act, Ch. 76.09 RCW that may affect the operability of the timber sale.

G-066 Governmental Regulatory Actions

a. Risk

Purchaser shall be responsible for any increased operational costs arising from any applicable foreign or domestic governmental regulation or order that does not cause contract performance to become commercially impracticable or that does not substantially frustrate the purpose of the contract. If impracticability or frustration results from Purchaser's failure to comply with this contract, Purchaser shall remain responsible for payment of the total contract price notwithstanding the impracticability or frustration.

b. Sale Area

When portions of the sale area become subject to a foreign or domestic governmental regulation or order that will likely prevent timber harvest for a period that will exceed the expiration date of this contract, and Purchaser has complied with this contract, the following shall apply:

i. RCW 79.15.140 shall govern all adjustments to the contract area.

c. Adjustment of Price

The State shall adjust the total contract price by subtracting from the total contract price an amount determined in the following manner: The State shall cause the timber sale area subject to governmental regulation or order to be measured. The State shall calculate the percentage of the total sale area subject to the governmental regulation or order. The State shall reduce the total contract price by that calculated percentage. However, variations in species, value, costs, or other items pertaining to the affected sale area will be analyzed and included in the adjustment if deemed appropriate by the State. The State will further reduce the total contract price by the reasonable cost of unamortized roads Purchaser constructed but was unable to fully use for removing timber. A reduction in total contract price terminates all of the Purchaser's rights to purchase and remove the timber and all other interest in the affected sale area.

G-070 Limitation on Damage

In the event of a breach of any provision of this contract by the State, the exclusive remedy available to Purchaser will be limited to a return of the initial deposit, unapplied payments, and credit for unamortized improvements made by Purchaser. The State shall not be liable for any damages, whether direct, incidental or consequential.

G-080 Scope of State Advice

No advice by any agent, employee, or representative of the State regarding the method or manner of performing shall constitute a representation or warranty that said method, manner or result thereof will conform to the contract or be suitable for Purchaser's purposes under the contract. Purchaser's reliance on any State advice regarding the method or manner of performance shall not relieve Purchaser of any risk or obligation under the contract. Purchaser retains the final responsibility for its operations under this contract and State shall not be liable for any injuries resulting from Purchaser's reliance on any State advice regarding the method or manner of performance.

G-091 Sale Area Adjustment

The Parties may agree to adjustments in the sale area boundary. The cumulative changes to the sale area during the term of the contract shall not exceed more than four percent of the original sale area. If the sale area is increased, the added forest products become a part of this contract. The State shall determine the volume added and shall calculate the increase to the total contract price using the rates set forth in clause G-101, G-102, or G-103. If the sale area is reduced, the State shall determine the volume to be reduced. The State shall calculate the reduction to the total contract price using the rates set forth in clause G-101, G-102, or G-103.

G-101 Forest Products Not Designated

Any forest products not designated for removal, which must be removed in the course of operations authorized by the State, shall be approved and designated by the Contract Administrator. Added forest products become a part of this contract and the Scribner log scale volume, as defined by the Northwest Log Rules Advisory Group, shall be determined by the Contract Administrator. Added forest products shall be paid for at the following contract payment rates per Mbf Scribner log scale.

The pricing schedule has not been set for the sale.

G-111 Title and Risk of Loss

Title to the forest products under this contract passes to the Purchaser after they are removed from the sale area, if adequate advance payment or payment security has been provided to the State under this contract. Purchaser bears all risk of loss of, or damage to, and has an insurable interest in, the forest products described in this contract from the time the sale is confirmed under RCW 79.15.120. Breach of this contract shall have no effect on this provision.

G-116 Sustainable Forestry Initiative® (SFI®) Certification

Forest products purchased under this contract are certified as being in conformance with the Sustainable Forestry Initiative 2022 Forest Management Standard under certificate number: BVC-SFIFM-018227.

Purchaser shall have at least one person regularly on-site during active operations that have completed training according to the requirements outlined within the SFI Standard. Purchaser shall designate in writing the name(s) of the individual(s) who will be on-site and provide proof of their successful completion of an approved training program prior to active operations.

G-120 Responsibility for Work

All work, equipment, and materials necessary to perform this contract shall be the responsibility of Purchaser. Any damage to improvements, except as provided in clause G-121 or unless the State issues an operating release pursuant to clause G-280, shall be repaired promptly to the satisfaction of the State and at Purchaser's expense.

G-121 Exceptions

Exceptions to Purchaser's responsibility in clause G-120 shall be limited exclusively to the following. These exceptions shall not apply where road damage occurs due to Purchaser's failure to take reasonable precautions or to exercise sound forest engineering and construction practices.

The State will bear the cost to repair damages caused by a third party. In all other cases, the Purchaser shall bear responsibility for the costs as described below.

Road is defined as the road bed, including but not limited to its component parts, such as cut and fill slopes, subgrade, ditches, culverts, bridges, and cattle guards.

For the purposes of this clause, damage will be identified by the State and is defined as:

1. Failure of (a) required improvements or roads designated in clause C-050, or (b) required or optional construction completed to the point that authorization to haul has been issued;
2. Caused by a single event from forces beyond the control of Purchaser, its employees, agents, or invitees, including independent contractors; and
3. Includes, but is not limited to natural disasters such as earthquakes, volcanic eruptions, landslides, and floods.

The repair work identified by the State shall be promptly completed by Purchaser at an agreed price. The State may elect to accomplish repairs by means of State-provided resources.

For each event, Purchaser shall be solely responsible for the initial \$5,000 in repairs. For repairs in excess of \$5,000, the parties shall share equally the portion of costs between \$5,000 and \$15,000. The State shall be solely responsible for the portion of the cost of repairs that exceed \$15,000.

Nothing contained in clauses G-120 and G-121 shall be construed as relieving Purchaser of responsibility for, or damage resulting from, Purchaser's operations or negligence, nor shall Purchaser be relieved from full responsibility for making good any defective work or materials. Authorization to haul does not warrant that Purchaser built roads are free from material defect and the State may require additional work, at Purchasers expense regardless of cost, to remedy deficiencies at any time.

G-140 Indemnity

To the fullest extent permitted by law, Purchaser shall indemnify, defend and hold harmless State, agencies of State and all officials, agents and employees of State, from and against all claims arising out of or resulting from the performance of the contract. "Claim" as used in this contract means any financial loss, claim, suit, action, damage, or expense, including but not limited to attorneys' fees, attributable for bodily injury, sickness, disease or death, or injury to or destruction of tangible property including loss of use resulting therefrom. Purchasers' obligations to indemnify, defend, and hold harmless includes any claim by Purchasers' agents, employees, representatives, or any subcontractor or its employees. Purchaser expressly agrees to indemnify, defend, and hold harmless State for any claim arising out of or incident to Purchasers' or any subcontractors' performance or failure to perform the contract. Purchasers' obligation to indemnify, defend, and hold harmless State shall not be eliminated or reduced by any actual or alleged concurrent negligence of State or its agents, agencies, employees and officials. Purchaser waives its immunity under Title 51 RCW to the extent it is required to indemnify, defend and hold harmless State and its agencies, officials, agents or employees.

G-150 Insurance

Purchaser shall, at its cost and expense, buy and maintain insurance of the types and amounts listed below. Failure to buy and maintain the required insurance may result in a breach and/or termination of the contract at State's option. State may suspend Purchaser operations until required insurance has been secured.

All insurance and surety bonds should be issued by companies admitted to do business within the State of Washington and have a rating of A-, Class VII or better in the most recently published edition of Best's Reports. If an insurer is not admitted, all insurance policies and procedures for issuing the insurance policies must comply with Chapter 48.15 RCW and 284-15 WAC.

The State of Washington, Department of Natural Resources region office of sale origin shall be provided written notice before cancellation or non-renewal of any insurance referred to therein, in accord with the following specifications:

1. Insurers subject to Chapter 48.18 RCW (admitted and regulated by the Insurance Commissioner): The insurer shall give the State 45 days advance notice of cancellation or non-renewal. If cancellation is due to non-payment of premium, the State shall be given 10 days advance notice of cancellation.
2. Insurers subject to Chapter 48.15 RCW (surplus lines): The State shall be given 20 days advance notice of cancellation. If cancellation is due to non-payment of premium, the State shall be given 10 days advance notice of cancellation.

Before starting work, Purchaser shall furnish State of Washington, Department of Natural Resources with a certificate(s) of insurance, executed by a duly authorized representative of each insurer, showing compliance with the insurance requirements specified in the contract. Insurance coverage shall be obtained by the Purchaser prior to operations commencing and continually maintained in full force until all contract obligations have been satisfied or an operating release has been signed by the State.

Purchaser shall include all subcontractors as insured under all required insurance policies, or shall furnish separate certificates of insurance and endorsements for each subcontractor. Subcontractor(s) must comply fully with all insurance requirements stated herein. Failure of subcontractor(s) to comply with insurance requirements does not limit Purchaser's liability or responsibility.

The State of Washington, Department of Natural Resources, its elected and appointed officials, agents and employees shall be named as an additional insured via endorsement on all general liability, excess, umbrella, and property insurance policies.

All insurance provided in compliance with this contract shall be primary as to any other insurance or self-insurance programs afforded to or maintained by State. Purchaser waives all rights against State for recovery of damages to the extent these damages are covered by general liability or umbrella insurance maintained pursuant to this contract.

By requiring insurance herein, State does not represent that coverage and limits will be adequate to protect Purchaser and such coverage and limits shall not limit Purchaser's liability under the indemnities and reimbursements granted to State in this contract.

The limits of insurance, which may be increased as deemed necessary by State of Washington, Department of Natural Resources, shall not be less than as follows:

Commercial General Liability (CGL) Insurance. Purchaser shall maintain general liability (CGL) insurance, and, if necessary, commercial umbrella insurance with a limit of not less than \$1,000,000.00 per each occurrence. If such CGL insurance contains aggregate limits, the General Aggregate limit shall be at least twice the "each occurrence" limit. CGL insurance shall have products-completed operations aggregate limit of at least two times the "each occurrence" limit. CGL coverage shall include a Logging and Lumbering Endorsement (i.e. Logger's Broad-Form) to cover the events

that include, but are not limited to, fire suppression expenses, accidental timber trespasses, and wildfire property damage with limits of not less than \$2,000,000.00 each occurrence.

CGL insurance shall be written on Insurance Services Office (ISO) occurrence form CG 00 01 (or a substitute form providing equivalent coverage). All insurance shall cover liability arising out of premises, operations, independent contractors, products completed operations, personal injury and advertising injury, and liability assumed under an insured contract (including the tort liability of another party assumed in a business contract), and contain separation of insured (cross liability) condition.

Employer's Liability "Stop Gap" Insurance. Purchaser shall buy employers liability insurance, and, if necessary, commercial umbrella liability insurance with limits not less than \$1,000,000.00 each accident for bodily injury by accident or \$1,000,000.00 each employee for bodily injury by disease.

Workers' Compensation Coverage. Purchaser shall comply with all State of Washington workers' compensation statutes and regulations. Workers' compensation coverage shall be provided for all employees of Purchaser and employees of any subcontractor or sub-subcontractor. Coverage shall include bodily injury (including death) by accident or disease, which exists out of or in connection with the performance of this contract. Except as prohibited by law, Purchaser waives all rights of subrogation against State for recovery of damages to the extent they are covered by workers' compensation, employer's liability, commercial general liability, or commercial umbrella liability insurance.

If Purchaser, subcontractor or sub-subcontractor fails to comply with all State of Washington workers' compensation statutes and regulations and State incurs fines or is required by law to provide benefits to or obtain coverage for such employees, Purchaser shall indemnify State. Indemnity shall include all fines, payment of benefits to Purchaser or subcontractor employees, or their heirs or legal representatives, and the cost of effecting coverage on behalf of such employees.

Business Auto Policy (BAP). Purchaser shall maintain business auto liability and, if necessary, commercial umbrella liability insurance with a limit not less than \$1,000,000.00 per accident. Such insurance shall cover liability arising out of "Any Auto". Business auto coverage shall be written on ISO form CA 00 01, or substitute liability form providing equivalent coverage. If necessary the policy shall be endorsed to provide contractual liability coverage and cover a "covered pollution cost or expense" as provided in the 1990 or later editions of CA 00 01. Purchaser waives all rights against State for the recovery of damages to the extent they are covered by business auto liability or commercial umbrella liability insurance.

G-160 Agents

The State's rights and duties will be exercised by the Region Manager at Castle Rock, Washington. The Region Manager will notify Purchaser in writing who is responsible for administering the contract. The Region Manager has sole authority to waive,

modify, or amend the terms of this contract in the manner prescribed in clause G-180. No agent, employee, or representative of the State has any authority to bind the State to any affirmation, representation, or warranty concerning the forest products conveyed beyond the terms of this contract.

Purchaser is required to have a person on site during all operations who is authorized to receive instructions and notices from the State. Purchaser shall inform the State in writing who is authorized to receive instructions and notices from the State, and any limits to this person's authority.

G-170 Assignment and Delegation

No rights or interest in this contract shall be assigned by Purchaser without prior written permission of the State. Any attempted assignment shall be void and ineffective for all purposes unless made in conformity with this paragraph. Purchaser may perform any duty through a delegate, but Purchaser is not thereby relieved of any duty to perform or any liability. Any assignee or delegate shall be bound by the terms of the contract in the same manner as Purchaser.

G-180 Modifications

Waivers, modifications, or amendments of the terms of this contract must be in writing signed by Purchaser and the State.

G-190 Contract Complete

This contract is the final expression of the Parties' agreement. There are no understandings, agreements, or representations, expressed or implied, which are not specified in this contract.

G-200 Notice

Notices required to be given under the following clauses shall be in writing and shall be delivered to Purchaser's authorized agent or sent by certified mail to Purchaser's address of record:

G-210 Violation of Contract

G-220 State Suspends Operations

All other notices required to be given under this contract shall be in writing and delivered to the authorized agent or mailed to the Party's post office address. Purchaser agrees to notify the State of any change of address.

G-210 Violation of Contract

- a. If Purchaser violates any provision of this contract, the Contract Administrator, by written notice, may suspend those operations in violation. If the violation is capable of being remedied, Purchaser has 30 days after receipt of a suspension notice to remedy the violation. If the violation cannot be remedied (such as a violation of WAC 240-15-015) or Purchaser fails to remedy the violation within 30 days after receipt of a suspension notice, the

State may terminate the rights of Purchaser under this contract and collect damages.

- b. If the contract expires pursuant to clause G-030 or G-031 without Purchaser having performed all its duties under this contract, Purchaser's right to operate is terminated and Purchaser shall not have the right to remedy the breach. This provision shall not relieve Purchaser of any payment obligations.
- c. The State has the right to remedy the breach in the absence of any indicated attempt by Purchaser or if Purchaser is unable, as determined by the State, to remedy the breach. Any expense incurred by the State shall be charged to Purchaser and shall be paid within 30 days of receipt of billing.
- d. If Purchaser's violation is a result of a failure to make a payment when due, in addition to a. and b. above, interest shall accrue on the unpaid balance at 12 percent per annum, beginning the date payment was due.

G-220 State Suspends Operations

The Contract Administrator may suspend any operation of Purchaser under this contract when the State is suffering, or there is a reasonable expectation the State will suffer environmental, monetary, or other damage if the operation is allowed to continue.

Purchaser shall be in breach of this contract if the operation continues after the suspension notice or if the operation resumes without prior approval and notice from the Contract Administrator.

Purchaser may request a modification of a suspension within 30 days of the start of suspension through the dispute resolution process in clause G-240. If this process results in a finding that the suspension exceeded the time reasonably necessary to stop or prevent damage to the State, Purchaser is entitled to request a contract term adjustment under clause G-040.

If it reasonably appears that the damage that the State is suffering, or can reasonably be expected to suffer if the operation is allowed to continue, will prevent harvest for a period that will exceed 6 months, and Purchaser has complied with this contract, the provisions of clause G-066 shall govern just as if the harvest was prevented by an applicable foreign or domestic governmental regulation or order.

G-230 Unauthorized Activity

Any cutting, removal, or damage of forest products by Purchaser, its employees, agents, or invitees, including independent contractors, in a manner inconsistent with the terms of this contract or State law, is unauthorized. Such activity may subject Purchaser to liability for triple the value of said forest products under RCW 79.02.320 or RCW 79.02.300 and may result in prosecution under RCW 79.02.330 or other applicable statutes.

G-240 Dispute Resolution

The following procedures apply in the event of a dispute regarding interpretation or administration of this contract and the parties agree that these procedures must be followed before a lawsuit can be initiated.

- a. In the event of a dispute, Purchaser must make a written request to the Region Manager for resolution prior to seeking other relief.
- b. The Region Manager will issue a written decision on Purchaser's request within ten business days.
- c. Within ten business days of receipt of the Region Manager's decision, Purchaser may make a written request for resolution to the Deputy Supervisor - Uplands of the Department of Natural Resources.
- d. Unless otherwise agreed, a conference will be held by the Deputy Supervisor - Uplands within 30 calendar days of the receipt of Purchaser's request for review of the Region Manager's written decision. Purchaser and the Region Manager will have an opportunity to present their positions. The Deputy Supervisor - Uplands will issue a decision within a reasonable time of being presented with both Parties' positions.

G-250 Compliance with All Laws

Purchaser shall comply with all applicable statutes, regulations and laws, including, but not limited to; chapter 27.53 RCW, chapter 68.50 RCW, WAC 240-15 and WAC 296-54. Failure to comply may result in forfeiture of this contract.

G-260 Venue

This contract shall be governed by the laws of the State of Washington. In the event of a lawsuit involving this contract, venue shall be proper only in Thurston County Superior Court.

G-270 Equipment Left on State Land

All equipment owned or in the possession of Purchaser, its employees, agents, or invitees, including independent contractors, shall be removed from the sale area and other State land by the termination date of this contract. Equipment remaining unclaimed on State land 60 days after the expiration of the contract period is subject to disposition as provided by law. Purchaser shall pay to the State all costs of moving, storing, and disposing of such equipment. The State shall not be responsible for any damages to or loss of the equipment or damage caused by the moving, storing or disposal of the equipment.

G-280 Operating Release

An operating release is a written document, signed by the State and Purchaser, indicating that Purchaser has been relieved of certain rights or responsibilities with regard to the entire or a portion of the timber sales contract. Purchaser and State may agree to an operating release for this sale, or portion of this sale, prior to the contract

expiration, when all contract requirements pertaining to the release area have been satisfactorily completed. Upon issuance of a release, Purchaser's right to cut and remove forest products on the released area will terminate.

G-310 Road Use Authorization

Purchaser is authorized to use the following State roads and roads for which the State has acquired easements and road use permits; E-5000, E-5035, E-5035A E-5036, E-5037, E-5038, E-5039, E-5800, E-7500 and E-7507 roads. The State may authorize in writing the use of other roads subject to fees, restrictions, and prior rights.

G-330 Pre-work Conference

Purchaser shall arrange with the Contract Administrator to review this contract and to examine the sale area before beginning any operations. A plan of operations shall be developed and agreed upon by the Contract Administrator and Purchaser before beginning any operations. To the extent that the plan of operations is inconsistent with the contract, the terms of the contract shall prevail. State's acceptance and approval of Purchaser's plan of operations shall not be construed as any statement or warranty that the plan of operations is adequate for Purchaser's purposes or complies with applicable laws.

G-340 Preservation of Markers

Any legal land subdivision survey corners and witness objects are to be preserved. If such are destroyed or disturbed, the Purchaser shall, at the Purchaser's own expense, re-establish them through a licensed land surveyor in accordance with U.S. General Land Office standards. Corners and/or witness objects that must be disturbed or destroyed in the process of road construction or logging shall be adequately referenced and/or replaced in accordance with RCW 58.24.040(8). Such references must be approved by the Contract Administrator prior to removal of said corners and/or witness objects.

G-360 Road Use Reservation

The State shall have the right to use, without charge, all existing roads and any road constructed or reconstructed on State lands by Purchaser under this contract. The State may extend such rights to others. If the State grants such rights to others, the State shall require performance or payment, as directed by the State, for their proportionate share of maintenance based on their use.

G-370 Blocking Roads

Purchaser shall not block the E-5000, E-5800 and E-7500, unless authority is granted in writing by the Contract Administrator.

G-430 Open Fires

Purchaser shall not set, or allow to be set by Purchaser's employees, agents, invitees and independent contractors, any open fire at any time of the year without first obtaining permission, in writing, from the Contract Administrator.

G-450 Encumbrances

This contract and Purchaser's activities are subject to the following:

DATA MISSING

Section P: Payments and Securities

P-011 Initial Deposit

Purchaser paid DATA MISSING initial deposit, which will be maintained pursuant to RCW 79.15.100(3). If the operating authority on this contract expires without Purchaser's payment of the full amount specified in Clause P-020, the initial deposit will be immediately forfeited to the State, and will be offset against Purchaser's remaining balance due. Any excess initial deposit funds not needed to ensure full payment of the contract price, or not needed to complete any remaining obligations of the Purchaser existing after contract expiration, will be refunded to the Purchaser.

P-020 Payment for Forest Products

Purchaser agrees to pay the total, lump sum contract price of \$231,400.00. The total contract price consists of a \$0.00 contract bid price plus \$231,400.00 in fees. Fees collected shall be retained by the state unless the contract is adjusted via the G-066 clause. Purchaser shall be liable for the entire purchase price, and will not be entitled to any refunds or offsets unless expressly stated in this contract.

THE PURCHASE PRICE SHALL NOT BE AFFECTED BY ANY FACTORS, INCLUDING: the amount of forest products actually present within the contract area, the actual acreage covered by the contract area, the amount or volume of forest products actually cut or removed by purchaser, whether it becomes physically impossible or uneconomic to remove the forest products, and whether the subject forest products have been lost or damaged by fire or any other cause. The only situations Purchaser may not be liable for the full purchase price are governed by clause G-066, concerning governmental regulatory actions taken during the term of the contract.

P-045 Guarantee of Payment

Purchaser will pay for forest products prior to cutting or will guarantee payment by posting an approved payment security. The amount of cash or payment security shall be determined by the State and shall equal or exceed the value of the cutting proposed by Purchaser.

P-050 Billing Procedure

The State will compute and forward to Purchaser statements of charges provided for in the contract. Purchaser shall deliver payment to the State on or before the date shown on the billing statement.

P-080 Payment Account Refund

Advance payments made under P-045 or P-045.2 remaining on account above the value for the charges shall be returned to Purchaser within 30 days following the final report of charges. Refunds not made within the 30 day period will accrue interest at the interest rate, as established by WAC 332-100-030, computed on a daily basis until paid.

P-090 Performance Security

Purchaser agrees to furnish, within 30 days of the confirmation date, security acceptable to the State in the amount of \$100,000.00. The Security provided shall guarantee performance of all provisions of this contract and payment of any damages caused by operations under this contract or resulting from Purchaser's noncompliance with any rule or law. Acceptable performance security may be in the form of a performance bond, irrevocable letter of credit, cash, savings or certificate of deposit account assignments, and must name the State as the obligee or beneficiary. A letter of credit must comply with Title 62A RCW, Article 5. Performance security must remain in full force over the duration of the contract length. Surety bonds issued shall conform to the issuance and rating requirements in clause G-150. The State shall retain the performance security pursuant to RCW 79.15.100. Purchaser shall not operate unless the performance security has been accepted by the State. If at any time the State decides that the security document or amount has become unsatisfactory, Purchaser agrees to suspend operations and, within 30 days of notification, to replace the security with one acceptable to the State or to supplement the amount of the existing security.

P-100 Performance Security Reduction

The State may reduce the performance security after an operating release has been issued if the State determines that adequate security exists for any remaining obligations of Purchaser.

Section H: Harvesting Operations

H-001 Operations Outside the Sale Boundaries

No operations shall occur outside the sale boundaries, as described within the contract, unless approved in writing by the State.

H-013 Reserve Tree Damage Definition

Reserve trees are trees required and designated for retention within the sale boundary. Purchaser shall protect reserve trees from being cut, damaged, or removed during operations.

Reserve tree damage exists when one or more of the following criteria occur as a result of Purchaser's operation, as determined by the Contract Administrator:

- a. A reserve tree has one or more scars on its trunk exposing the cambium layer, which in total exceeds 100 square inches.
- b. A reserve tree top is broken or the live crown ratio is reduced below 30 percent.
- c. A reserve tree has more than 1/3 of the circumference of its root system injured such that the cambium layer is exposed.

If the Contract Administrator determines that a reserve tree has been cut or damaged, the Purchaser shall provide a replacement reserve tree of like condition, size, and

species within the sale unit containing the damaged leave tree, as approved by the Contract Administrator. Purchaser may be required to pay liquidated damages for Excessive Reserve Tree Damage as detailed in clause D-041.

Removal of designated reserve trees from the sale area is unauthorized, and may invoke the use of the G-230 'Unauthorized Activity' clause. Purchaser is required to leave all cut or damaged reserve trees on site.

H-017 Preventing Excessive Soil Disturbance

Operations may be suspended when soil rutting exceeds 12 inches as measured from the natural ground line. To reduce soil damage, the Contract Administrator may require water bars to be constructed, grass seed to be placed on exposed soils, or other mitigation measures. Suspended operations shall not resume unless approval to do so has been given, in writing, by the Contract Administrator.

H-035 Fall Trees Into Sale Area

Trees shall be felled into the sale area unless otherwise approved by the Contract Administrator.

H-040 Purchaser Harvest Plan

Purchaser shall, as part of the plan of operations, prepare an acceptable harvest plan for all units. The plan shall address the felling, bucking and yarding, which are part(s) of this contract. The harvest plan shall be approved by the Contract Administrator prior to beginning the harvest operation. Purchaser shall not deviate from the harvest plan without prior written approval by the Contract Administrator.

H-051 Branding and Painting

Purchaser shall provide a State of Washington registered log brand, acceptable to the State, unless the State agrees to furnish the brand. All purchased timber shall be branded in a manner that meets the requirements of WAC 240-15-030(2)(a)(i). All timber purchased under a contract designated as export restricted shall also be painted in a manner that meets the requirements of WAC 240-15-030(2)(a)(ii).

For pulp loads purchased under a contract designated as export restricted, Purchaser shall brand at least 3 logs with legible brands at one end. Also, 10 logs shall be painted at one end with durable red paint.

H-080 Snags Not to be Felled

Snags not required to be felled for safety reasons may be left standing. Snags felled for safety reasons shall not be removed and must remain where felled.

H-120 Harvesting Equipment

Forest products sold under this contract shall be harvested and removed using shovel, tracked skidder or 6 Wheeled Skidder similar to Eco Tracks™, cable or cable-assist. Authority to use other equipment or to operate outside the equipment specifications detailed above must be approved in writing by the State.

H-125 Log Suspension Requirements

Lead-end suspension is required for all yarding activities.

H-140 Special Harvest Requirements

Purchaser shall accomplish the following during the harvest operations:

A. Active Haul Routes will be posted with CB channels by Purchaser.

B. Ground based yarding equipment shall only operate during dry soil conditions.

C. Shovels must be large enough to pick up one end of the largest log 35 feet from machine.

D. Ground based yarding equipment will not be permitted on sustained slopes over 45 percent.

E. Self-Leveling ground based yarding equipment will not be permitted on sustained slopes over 55 percent.

F. 6 Wheeled skidder with tracks similar to ECO-TRACKS™, will not be permitted on sustained slopes over 35 percent.

G. All skid trails used by the 6 wheel drive skidder shall be identified by the purchaser and approved by the Contract Administrator in writing.

H. No trees 60 inched DBH or larger may be felled.

Permission to do otherwise must be granted in writing by the Contract Administrator.

H-141 Additional Harvest Requirements

Purchaser shall accomplish the following during the harvest operations:

A. Sediment delivery from roads will not be allowed. Hauling operations will be shut down as needed until conditions improve or work can be completed that eliminates the delivery of sediment.

B. No Yarding will be permitted through or over areas identified to be potentially unstable on the FPA Slope Stability Form and all maps.

C. Within shovel logging areas, the shovel operator shall break up concentrations of logging debris greater than 10 feet by 10 feet to allow exposure of natural soils to ensure proper reforestation.

D. Any and all snags cut because of safety concerns cannot be removed and must remain where they were felled.

Permission to do otherwise must be granted in writing by the State.

H-190 Completion of Settings

Operations begun on any setting of the sale area shall be completed before any operation begins on subsequent settings unless authorized in writing by the Contract Administrator.

H-220 Protection of Residual or Adjacent Trees

Unless otherwise specified by this contract, the Contract Administrator shall identify damaged adjacent or leave trees that shall be paid for according to clause G-230.

Section C: Construction and Maintenance

C-040 Road Plan

Road construction and associated work provisions of the Road Plan for this sale, dated 6/13/2023 are hereby made a part of this contract.

C-050 Purchaser Road Maintenance and Repair

Purchaser shall perform work at their own expense on E-5035, E-5035A, E-5036, E-5037, E-5038, E-5039, E-5800 and E-7507 roads. All work shall be completed to the specifications detailed in the Road Plan.

C-060 Designated Road Maintainer

If required by the State, Purchaser shall perform maintenance and replacement work as directed by the Contract Administrator on all roads not listed in Clause C-050. Purchaser shall furnish a statement in a form satisfactory to the State showing the costs incurred while performing this work. Costs shall be based on the rates set forth in the equipment rate schedule on file at the Region office or Engineering Division in Olympia. The State shall reimburse Purchaser for said costs within 30 days of receipt and approval of the statement.

C-080 Landing Locations Approved Prior to Construction

Landings shall be marked by Purchaser and approved by the Contract Administrator prior to construction.

C-140 Water Bars

Purchaser shall, as directed by the Contract Administrator, construct water bars across haul roads, skid trails and fire trails as necessary to control soil erosion and water pollution.

Section S: Site Preparation and Protection

S-001 Emergency Response Plan

An Emergency Response Plan (ERP) shall be provided to the Contract Administrator containing but not limited to, valid contact numbers and procedures for medical emergencies, fire, hazardous spills, forest practice violations and any unauthorized or unlawful activity on or in the vicinity of the sale area. The Contract Administrator and the State shall be promptly notified whenever an incident occurs requiring an emergency response.

The ERP must be presented for inspection at the prework meeting and kept readily available to all personnel, including subcontractors, on site during active operations.

S-010 Fire Hazardous Conditions

Purchaser acknowledges that operations under this Contract may increase the risk of fire. Purchaser shall conduct all operations under this agreement following the requirements of WAC 332-24-005 and WAC 332-24-405 and further agrees to use the highest degree of care to prevent uncontrolled fires from starting.

In the event of an uncontrolled fire, Purchaser agrees to provide equipment and personnel working at the site to safely and effectively engage in first response fire suppression activity.

Purchaser's failure to effectively engage in fire-safe operations is considered a breach and may result in suspension of operations.

S-030 Landing Debris Clean Up

Landing debris shall be disposed of in a manner approved in writing by the Contract Administrator.

S-035 Logging Debris Clean Up

Slash and debris created from harvest activities shall be treated in a manner approved in writing by the Contract Administrator.

S-040 Noxious Weed Control

Purchaser shall notify the Contract Administrator in advance of moving equipment onto State lands. Purchaser shall thoroughly clean all off road equipment prior to entry onto State land to remove contaminated soils and noxious weed seed. If equipment is moved from one DNR project area to another, the Contract Administrator reserves the right to require the cleaning of equipment. Equipment shall be cleaned at a location approved by the Contract Administrator.

S-050 Cessation of Operations for Low Humidity

When the humidity is 30 percent or lower on the sale area, all operations must cease unless authority to continue is granted by the State in writing.

S-060 Pump Truck or Pump Trailer

Purchaser shall provide a fully functional pump truck or pump trailer equipped to meet the specifications of WAC 332-24-005 and WAC 332-24-405 during the "closed season" or as extended by the State and shall provide trained personnel to operate this equipment on the sale area during all operating periods.

S-070 Water Supply

Purchaser shall provide, during the "closed season", a water supply with a minimum capacity of 300 gallons for rapid filling of pump trucks or trailers at a location designated by the Contract Administrator.

S-100 Stream Cleanout

Slash or debris which enters all typed streams as a result of operations under this contract and which is identified by the Contract Administrator shall be removed and deposited in a stable position. Removal of slash or debris shall be accomplished in a manner that avoids damage to the natural stream bed and bank vegetation.

S-110 Resource Protection

No ground based equipment may operate within 25 feet of type 5 streams unless authority is granted in writing by the Contract Administrator.

S-130 Hazardous Materials

a. Hazardous Materials and Waste - Regulatory Compliance

Purchaser is responsible for understanding and complying with all applicable local, state, and federal hazardous material/waste laws and regulations for operations conducted under this contract. Such regulations pertain to, but may not be limited to, hazardous material storage, handling and transport, personnel protection, release notification and emergency response, cleanup, and waste disposal.

Purchaser shall be responsible for restoring the site in the event of a spill or other releases of hazardous material/waste during operations conducted under this contract.

b. Hazardous Materials Spill Prevention

All operations shall be conducted in a manner that avoids the release of hazardous materials, including petroleum products, into the environment (water, air or land).

c. Hazardous Materials Spill Containment, Control and Cleanup

If safe to do so, Purchaser shall take immediate action to contain and control all hazardous material spills. Purchaser shall ensure that enough quick response spill kits capable of absorbing 10 gallons of oil, coolant, solvent or contaminated water are available on site to quickly address potential spills from any piece of equipment at all times throughout active operations. If large quantities of bulk fuel/other hazardous materials are stored on site, Purchaser must be able to effectively control a container leak and contain & recover a hazmat spill equal to the largest single on site storage container volume. (HAZWOPER reg. 29CFR 1910.120 (j) (1) (vii)).

d. Hazardous Material Release Reporting

Releases of oil or hazardous materials to the environment must be reported according to the State Department of Ecology (ECY). It is the responsibility

of the Purchaser to have all emergency contact information readily available and a means of remote communication for purposes of quick notification. In the event of a spill covered in part a., the Purchaser is responsible for immediately notifying all the following:

- Department of Emergency Management at 1-800-258-5990
- National Response Center at 1-800-424-8802
- Appropriate Department of Ecology (ECY) at 1-800-645-7911
- DNR Contract Administrator

S-131 Refuse Disposal

As required by RCW 70.93, All Purchaser generated refuse shall be removed from state lands for proper disposal prior to termination of this contract. No refuse shall be burned, buried or abandoned on state forest lands. All refuse shall be transported in a manner such that it is in compliance with RCW 70.93 and all loads or loose materials shall be covered/secured such that these waste materials are properly contained during transport.

Section D: Damages

D-013 Liquidated Damages or Failure to Perform

The following clauses provide for payments by Purchaser to the State for breaches of the terms of this contract other than failure to perform. These payments are agreed to as liquidated damages and not as penalties. They are reasonable estimates of anticipated harm to the State, which will be caused by Purchaser's breach. These liquidated damages provisions are agreed to by the State and Purchaser with the understanding of the difficulty of proving loss and the inconvenience or infeasibility of obtaining an adequate remedy. These liquidated damages provisions provide greater certainty for the Purchaser by allowing the Purchaser to better assess its responsibilities under the contract.

Clause P-020 governs Purchaser's liability in the event Purchaser fails to perform any of the contract requirements other than the below liquidated damage clauses without written approval by the State. Purchaser's failure to pay for all or part of the forest products sold in this contract prior to expiration of the contract term results in substantial injury to the State. Therefore, Purchaser agrees to pay the State the full lump sum contract price in P-020 in the event of failure to perform.

D-041 Reserve Tree Excessive Damage

When Purchaser's operations exceed the damage limits set forth in clause H-013, Reserve Tree Damage Definition, and when the Contract Administrator determines that a suitable replacement for a damaged reserve tree is not possible, the damaged trees result in substantial injury to the State. The value of the damaged reserve trees at the time of the breach is not readily ascertainable. Therefore, the Purchaser agrees to pay the State as liquidated damages at the rate of \$1,000.00 per tree for all damaged reserve trees that are not replaced in all harvest units.

SIGNATURES

This agreement may be executed in any number of counterparts (including by electronic mail in portable document format (.pdf), or by facsimile) each of which shall be deemed an original but all of which, when taken together, shall constitute one and the same Agreement binding on all parties.

IN WITNESS WHEREOF, the Parties hereto have entered into this contract.

STATE OF WASHINGTON
DEPARTMENT OF NATURAL RESOURCES

Purchaser

Scott Sargent
Pacific Cascade Region Manager

Print Name

Date: _____

Date: _____

Address: _____

CORPORATE ACKNOWLEDGEMENT
(Required for both LLC and Inc. Entities)

STATE OF _____)

COUNTY OF _____)

On this _____ day of _____, 20____, before me personally
appeared _____

_____ to me known to be the
_____ of the corporation
that executed the within and foregoing instrument and acknowledged said instrument to be the
free and voluntary act and deed of the corporation, for the uses and purposes therein mentioned,
and on oath stated that (he/she was) (they were) authorized to execute said instrument.

IN WITNESS WHEREOF, I have hereunto set my hand and affixed my official seal the day and
year first above written.

Notary Public in and for the State of

My appointment expires _____

PRE-CRUISE NARRATIVE

Sale Name: Stairway to Hemlock	Region: Pacific Cascade
Agreement #: 30-087001	District: St.Helens
Contact Forester: Karsen Fischer Phone / Location: 360-751-6115	County(s): Choose a county, Wahkiakum
Alternate Contact: Marty Cozart Phone / Location: 360-669-3822	Other information: Click here to enter text.

Type of Sale: Lump Sum	
Harvest System: Ground based Click here to enter text.	95%
Harvest System: Uphill Cable Click here to enter text.	5%
Harvest System: Select harvest system Click here to enter text.	Click here to enter percent sale acres.

UNIT ACREAGES AND METHOD OF DETERMINATION:

Unit # Harvest R/W or RMZ WMZ	Legal Description (Enter only one legal for each unit) Sec/Twp/Rng	Grant or Trust	Gross Proposal Acres	Deductions from Gross Acres (No harvest acres)				Net Harvest Acres	Acreage Determination (List method and error of closure if applicable)
				RMZ/WMZ Acres	Leave Tree Acres	Existing Road Acres	Other Acres (describe)		
1	Sec 23 / T9N / R5W	10	44	22	2	0	0	20	Combination
2	Sec 23 / T9N / R5W	10	59	25	3	0	0	31	Combination
3	Sec 13, 14, 23, 24 / T9N/ R5W	07/10	164	60	8	0	0	96	Combination
4 ROW	Sec 14 / T9N / R5W	07	2	0	0	0	0	2	Combination
TOTAL ACRES			269	107	13	0	0	149	

HARVEST PLAN AND SPECIAL CONDITIONS:

Unit #	Harvest Prescription: (Leave, take, paint color, tags, flagging etc.)	Special Management areas:	Other conditions (# leave trees, etc.)
1	Variable Retention Harvest; Boundaries are marked with white "Timber Sale Boundary" tags and pink flagging.		184 Leave Trees

	Clumped leave trees are marked with yellow "Leave Tree Area" tags and pink flagging. Individual leave trees are marked with blue paint.		
2	Variable Retention Harvest; Boundaries are marked with white "Timber Sale Boundary" tags and pink flagging. Clumped leave trees are marked with yellow "Leave Tree Area" tags and pink flagging. Individual leave trees are marked with blue paint.		343 Leave Trees
3	Variable Retention Harvest; Boundaries are marked with white "Timber Sale Boundary" tags and pink flagging. Clumped leave trees are marked with yellow "Leave Tree Area" tags and pink flagging. Individual leave trees are marked with blue paint.		889 Leave Trees
4 ROW	Unit boundaries are marked with orange "Right Of Way" tags and pink flagging.		N/A

OTHER PRE-CRUISE INFORMATION:

Unit #	Primary,secondary Species / Estimated Volume (MBF)	Access information (Gates, locks, etc.)	Photos, traverse maps required
1	Douglas-fir, Western Hemlock; 959 MBF	E-5000	Driving/Logging Plan Map
2	Douglas-fir, Western Hemlock; 2,023 MBF	E-5000	Driving/Logging Plan Map
3	Douglas-fir, Western Hemlock; 4,621 MBF	E-5000	Driving/Logging Plan Map
4 ROW	Western Hemlock, Red Alder; 3 MBF	E-5000	Driving/Logging Plan Map
TOTAL MBF	7,606 MBF		

REMARKS:

--

Prepared By: Karsen Fischer Date: 04/06/2023	Title:	CC:
---	---------------	------------

Timber Sale Cruise Report Stairway to Hemlock

Sale Name: STAIRWAY TO HEMLOCK

Sale Type: LUMP SUM

Region: PACIFIC CASC

District: ST.HELENS

Lead Cruiser: AMDouglas

Other Cruisers: BEWarnstadt, DBuchanan

Cruise Narrative:

Location:

Stairway to Hemlock is located 7 miles northeast of Cathlamet, WA.

The sale is accessed from State Route 4, Mill Creek, and Beaver Creek Rds. All units are adjacent to the E-5000 and E-5800 roads.

Cruise Design: 146 Variable Radius Plots were used to measure 413 trees. Diameters were recorded to the nearest whole inch. Bole heights were measured to a 5" top or estimated break point. Trees were segmented into lengths based on a preference for long logs and taking into account location of defect. Preferred length for conifers is 40'. Preferred length for hardwoods is 30'. Plots that landed in leave tree areas were dropped from the cruise.

Timber Quality:

All units are densely stocked with western hemlock; and spaced out, large Douglas-firs. Unit 1 also contains a bit of noble fir. Trace amounts of mature red alder can be found along old grades.

Some hemlocks contain broken tops, spike knots, and/or pockets of rot. No mistletoe was observed.

High quality Douglas-fir segments are present.

Logging and Stand Conditions:

Stairway to Hemlock ranges from flat-moderately sloped. Projected harvesting method is 100% ground based. Ground is soft, composed of mosses or a dense duff in many places. The understory is clear and conducive to foot travel.

General Remarks:

Unit 4 Right of Way is laid out on an old grade that starts at the E-5000 road and extends into the south end of Unit 3.

A dense wall of hemlock prevents easy access into Unit 3 from along the E-5800 (north side of unit). A small trail was cut into the western edge where the unit meets the road.

Timber Sale Notice Volume (MBF)

Sp	DBH	Rings/In	Age	MBF Volume by Grade					
				All	Spec Mill	2 Saw	3 Saw	4 Saw	Utility
WH	18.5			7,956		4,954	2,510	417	74
DF	25.8	7.9		789	9	669	96	15	1
NF	28.1			84		77	7		
RA	15.2			41		17	7	17	
RC	21.5			28			26	2	
MA	9.0			2					2
ALL	19.2	7.9		8,898	9	5,716	2,646	451	77

Timber Sale Notice Weight (tons)

Sp	Tons by Grade					
	All	Spec Mill	2 Saw	3 Saw	4 Saw	Utility
WH	63,349		36,775	21,794	4,103	677
DF	5,290	52	4,262	835	136	5
NF	505		440	65		
RA	340		115	53	172	
RC	201			186	14	
MA	11					11
ALL	69,696	52	41,592	22,934	4,425	693

Timber Sale Overall Cruise Statistics

BA (sq ft/acre)	BA SE (%)	V-BAR (bf/sq ft)	V-BAR SE (%)	Net Vol (bf/acre)	Vol SE (%)
310.2	2.7	192.6	1.1	59,721	2.9

Timber Sale Unit Cruise Design

Unit	Design	Cruise Acres	FMA Acres	N Plots	N Cruise Plots	N Void Plots
STAIRWAY TO HEMLOCK U1	B1C: VR, 1 BAF (46.94) Measure/Count Plots, Sighting Ht = 4.5 ft	20.0	22.0	18	9	0
STAIRWAY TO HEMLOCK U2	B1C: VR, 1 BAF (46.94) Measure/Count Plots, Sighting Ht = 4.5 ft	31.0	34.6	31	16	0
STAIRWAY TO HEMLOCK U3	B1C: VR, 1 BAF (46.94) Measure/Count Plots, Sighting	96.0	104.4	94	40	2

Unit	Design	Cruise Acres	FMA Acres	N Plots	N Cruise Plots	N Void Plots
	Ht = 4.5 ft					
STAIRWAY TO HEMLOCK U4 ROW	B1: VR, 1 BAF (46.94) Measure All, Sighting Ht = 4.5 ft	2.0	1.5	3	3	0
All		149.0	162.6	146	68	2

Timber Sale Log Grade x Sort Summary

Sp	Status	Grade	Sort	Dia	Len	BF Gross	BF Net	Defect %	Tons	MBF Net
DF	LIVE	2 SAW	Domestic	18.4	39	3,737	3,432	8.2	3,244.2	511.3
DF	LIVE	2 SAW	HQ-A	12.8	40	91	91	0.0	103.9	13.6
DF	LIVE	2 SAW	HQ-B	17.2	40	999	964	3.5	913.7	143.7
DF	LIVE	3 SAW	Domestic	9.3	35	568	530	6.7	706.4	79.0
DF	LIVE	3 SAW	HQ-B	10.1	40	114	112	2.0	128.8	16.7
DF	LIVE	4 SAW	Domestic	6.1	23	103	98	4.7	136.0	14.6
DF	LIVE	CULL	Cull	6.8	6	3	0	100.0	0.0	0.0
DF	LIVE	SPECIAL MILL	HQ-A	19.3	40	60	60	0.0	51.8	9.0
DF	LIVE	UTILITY	Pulp	5.0	14	6	6	0.0	4.8	0.8
MA	LIVE	UTILITY	Pulp	5.0	22	11	11	0.0	11.3	1.7
NF	LIVE	2 SAW	Domestic	18.0	40	525	514	2.2	440.2	76.6
NF	LIVE	3 SAW	Domestic	9.1	35	51	49	2.9	65.1	7.4
NF	LIVE	CULL	Cull	11.5	5	2	0	100.0	0.0	0.0
RA	LIVE	2 SAW	Domestic	14.9	30	131	112	14.5	115.1	16.6
RA	LIVE	3 SAW	Domestic	11.9	30	50	46	9.0	53.1	6.8
RA	LIVE	4 SAW	Domestic	6.4	38	125	116	7.3	172.1	17.3
RA	LIVE	CULL	Cull	5.1	2	6	0	100.0	0.0	0.0
RC	LIVE	3 SAW	Domestic	11.0	40	182	177	3.3	186.4	26.3
RC	LIVE	4 SAW	Domestic	5.2	27	12	11	12.4	14.1	1.6
RC	LIVE	CULL	Cull	6.2	10	4	0	100.0	0.0	0.0
WH	LIVE	2 SAW	Domestic	15.4	40	35,124	33,249	5.3	36,775.0	4,954.1
WH	LIVE	3 SAW	Domestic	9.1	39	17,339	16,845	2.9	21,794.2	2,509.9
WH	LIVE	4 SAW	Domestic	5.9	27	2,899	2,800	3.4	4,102.7	417.3
WH	LIVE	CULL	Cull	6.0	7	336	0	100.0	0.0	0.0
WH	LIVE	UTILITY	Pulp	7.0	14	519	499	4.0	677.2	74.3

Timber Sale Log Sort x Diameter Bin Summary

Sp	Bin	Status	Sort	Dia	Len	BF Net	Defect %	Tons	MBF Net
DF	5 - 7	LIVE	Pulp	5.0	14	6	0.0	4.8	0.8
DF	5 - 7	LIVE	Domestic	6.1	28	151	3.0	197.5	22.5
DF	5 - 7	LIVE	Cull	6.7	7	0	100.0	0.0	0.0
DF	8 - 11	LIVE	Cull	8.3	2	0	100.0	0.0	0.0
DF	8 - 11	LIVE	Domestic	9.6	34	477	7.4	645.0	71.0
DF	8 - 11	LIVE	HQ-B	9.9	40	112	2.0	128.8	16.7
DF	12 - 19	LIVE	HQ-A	13.9	40	152	0.0	155.7	22.6
DF	12 - 19	LIVE	Domestic	15.3	39	1,460	6.7	1,475.3	217.5
DF	12 - 19	LIVE	HQ-B	16.4	40	734	2.9	709.1	109.4
DF	20+	LIVE	HQ-B	22.0	40	230	5.1	204.6	34.3
DF	20+	LIVE	Domestic	23.3	40	1,972	9.2	1,768.9	293.8
MA	5 - 7	LIVE	Pulp	5.0	22	11	0.0	11.3	1.7
NF	5 - 7	LIVE	Domestic	7.2	31	6	0.0	8.8	0.9
NF	8 - 11	LIVE	Domestic	8.6	35	20	7.1	33.0	2.9
NF	8 - 11	LIVE	Cull	11.5	5	0	100.0	0.0	0.0
NF	12 - 19	LIVE	Domestic	14.9	40	220	3.9	221.7	32.9
NF	20+	LIVE	Domestic	22.0	40	317	0.8	241.8	47.2
RA	5 - 7	LIVE	Cull	5.1	9	0	100.0	0.0	0.0
RA	5 - 7	LIVE	Domestic	5.5	40	70	7.7	105.0	10.4
RA	8 - 11	LIVE	Domestic	10.0	30	92	7.8	120.3	13.7
RA	12 - 19	LIVE	Domestic	13.8	30	84	7.7	83.8	12.5
RA	20+	LIVE	Domestic	21.0	30	28	30.0	31.3	4.2
RC	5 - 7	LIVE	Cull	5.0	10	0	100.0	0.0	0.0
RC	5 - 7	LIVE	Domestic	5.1	24	11	12.4	14.1	1.6
RC	8 - 11	LIVE	Domestic	9.4	39	82	5.6	104.2	12.2
RC	12 - 19	LIVE	Cull	12.6	11	0	100.0	0.0	0.0
RC	12 - 19	LIVE	Domestic	16.8	40	13	7.5	14.2	2.0
RC	20+	LIVE	Domestic	24.1	40	82	0.0	68.0	12.1
WH	< 5	LIVE	Pulp	2.2	19	1	0.0	4.7	0.1
WH	5 - 7	LIVE	Cull	5.5	6	0	100.0	0.0	0.0
WH	5 - 7	LIVE	Domestic	6.1	31	5,239	2.8	7,428.2	780.6
WH	5 - 7	LIVE	Pulp	6.3	13	272	7.0	372.1	40.5
WH	8 - 11	LIVE	Cull	8.9	7	0	100.0	0.0	0.0
WH	8 - 11	LIVE	Pulp	8.9	14	109	0.0	167.8	16.2
WH	8 - 11	LIVE	Domestic	9.7	38	14,307	3.0	18,351.5	2,131.8
WH	12 - 19	LIVE	Pulp	13.9	21	118	0.0	132.7	17.5
WH	12 - 19	LIVE	Domestic	14.8	40	28,154	4.4	31,559.9	4,195.0

Sp	Bin	Status	Sort	Dia	Len	BF Net	Defect %	Tons	MBF Net
WH	12 - 19	LIVE	Cull	15.6	7	0	100.0	0.0	0.0
WH	20+	LIVE	Domestic	21.9	40	5,193	9.9	5,332.2	773.8
WH	20+	LIVE	Cull	22.4	18	0	100.0	0.0	0.0

Cruise Unit Report STAIRWAY TO HEMLOCK U1

Unit Sale Notice Volume (MBF): STAIRWAY TO HEMLOCK U1

Sp	DBH	Rings/In	Age	MBF Volume by Grade				
				All	2 Saw	3 Saw	4 Saw	Utility
WH	18.1			1,116	641	412	60	3
NF	28.1			84	77	7		
DF	24.4			47	40	7	1	
RC	16.0			5		4	1	
ALL	18.9			1,252	757	430	61	3

Unit Cruise Design: STAIRWAY TO HEMLOCK U1

Design	Cruise Acres	FMA Acres	N Plots	N Cruise Plots	N Void Plots
B1C: VR, 1 BAF (46.94) Measure/Count Plots, Sighting Ht = 4.5 ft	20.0	22.0	18	9	0

Unit Cruise Summary: STAIRWAY TO HEMLOCK U1

Sp	Cruised Trees	All Trees	Trees/Plot	Ring-Count Trees
WH	48	101	5.6	0
NF	6	6	0.3	0
DF	3	4	0.2	0
RC	1	1	0.1	0
ALL	58	112	6.2	0

Unit Cruise Statistics: STAIRWAY TO HEMLOCK U1

Sp	BA (sq ft/acre)	BA CV (%)	BA SE (%)	V-BAR (bf/sq ft)	V-BAR CV (%)	V-BAR SE (%)	Net Vol (bf/acre)	Vol CV (%)	Vol SE (%)
WH	263.4	31.8	7.5	211.9	17.1	2.5	55,807	36.2	7.9
NF	15.6	308.7	72.8	268.2	14.1	5.8	4,196	309.0	73.0
DF	10.4	246.7	58.2	226.2	18.6	10.7	2,360	247.4	59.1
RC	2.6	424.3	100.0	86.7	0.0	0.0	226	424.3	100.0
ALL	292.1	21.0	5.0	214.3	20.2	2.7	62,589	29.2	5.6

Unit Summary: STAIRWAY TO HEMLOCK U1

Sp	Status	Rx	N	D	DBH	BL	THT	BF Gross	BF Net	Defect %	TPA	BA	RD	MBF Net
DF	LIVE	CUT	3	ALL	24.4	116	149	2,543	2,360	7.2	3.2	10.4	2.1	47.2
NF	LIVE	CUT	6	ALL	28.1	119	154	4,309	4,196	2.6	3.6	15.6	3.0	83.9
RC	LIVE	CUT	1	ALL	16.0	61	75	254	226	11.0	1.9	2.6	0.7	4.5
WH	LIVE	CUT	48	ALL	18.1	98	124	58,930	55,807	5.3	147.4	263.4	61.9	1,116.1
ALL	LIVE	CUT	58	ALL	18.5	98	125	66,035	62,589	5.2	156.1	292.1	67.6	1,251.8
ALL	ALL	ALL	58	ALL	18.5	98	125	66,035	62,589	5.2	156.1	292.1	67.6	1,251.8

Cruise Unit Report STAIRWAY TO HEMLOCK U2

Unit Sale Notice Volume (MBF): STAIRWAY TO HEMLOCK U2

Sp	DBH	Rings/In	Age	MBF Volume by Grade				
				All	2 Saw	3 Saw	4 Saw	Utility
WH	18.4			1,751	1,071	571	94	14
DF	24.5	7.5		170	148	19	3	
RC	25.0			17		17		
ALL	19.1	7.5		1,938	1,219	607	98	14

Unit Cruise Design: STAIRWAY TO HEMLOCK U2

Design	Cruise Acres	FMA Acres	N Plots	N Cruise Plots	N Void Plots
B1C: VR, 1 BAF (46.94) Measure/Count Plots, Sighting Ht = 4.5 ft	31.0	34.6	31	16	0

Unit Cruise Summary: STAIRWAY TO HEMLOCK U2

Sp	Cruised Trees	All Trees	Trees/Plot	Ring-Count Trees
WH	82	194	6.3	0
DF	13	17	0.5	1
RC	3	3	0.1	0
ALL	98	214	6.9	1

Unit Cruise Statistics: STAIRWAY TO HEMLOCK U2

Sp	BA (sq ft/acre)	BA CV (%)	BA SE (%)	V-BAR (bf/sq ft)	V-BAR CV (%)	V-BAR SE (%)	Net Vol (bf/acre)	Vol CV (%)	Vol SE (%)
WH	293.8	34.8	6.2	192.3	22.6	2.5	56,481	41.4	6.7
DF	25.7	123.1	22.1	213.0	10.7	3.0	5,482	123.6	22.3
RC	4.5	409.4	73.5	121.1	62.7	36.2	550	414.2	82.0
ALL	324.0	32.3	5.8	192.9	23.0	2.3	62,512	39.6	6.2

Unit Summary: STAIRWAY TO HEMLOCK U2

Sp	Status	Rx	N	D	DBH	BL	THT	BF Gross	BF Net	Defect %	TPA	BA	RD	MBF Net
DF	LIVE	CUT	13	ALL	24.5	108	138	5,817	5,482	5.8	7.9	25.7	5.2	169.9
RC	LIVE	CUT	3	ALL	25.0	60	75	588	550	6.4	1.3	4.5	0.9	17.0

Sp	Status	Rx	N	D	DBH	BL	THT	BF Gross	BF Net	Defect %	TPA	BA	RD	MBF Net
WH	LIVE	CUT	82	ALL	18.4	94	121	60,726	56,481	7.0	159.1	293.8	68.5	1,750.9
ALL	LIVE	CUT	98	ALL	18.8	94	122	67,131	62,512	6.9	168.3	324.0	74.6	1,937.9
ALL	ALL	ALL	98	ALL	18.8	94	122	67,131	62,512	6.9	168.3	324.0	74.6	1,937.9

Cruise Unit Report STAIRWAY TO HEMLOCK U3

Unit Sale Notice Volume (MBF): STAIRWAY TO HEMLOCK U3

Sp	DBH	Rings/In	Age	MBF Volume by Grade					
				All	Spec Mill	2 Saw	3 Saw	4 Saw	Utility
WH	18.6			5,029		3,200	1,513	259	57
DF	26.5	8.0		563	9	475	70	8	1
RA	14.9			33		14	4	15	
RC	16.0			6			5	1	
ALL	19.4	8.0		5,631	9	3,689	1,593	283	58

Unit Cruise Design: STAIRWAY TO HEMLOCK U3

Design	Cruise Acres	FMA Acres	N Plots	N Cruise Plots	N Void Plots
B1C: VR, 1 BAF (46.94) Measure/Count Plots, Sighting Ht = 4.5 ft	96.0	104.4	94	40	2

Unit Cruise Summary: STAIRWAY TO HEMLOCK U3

Sp	Cruised Trees	All Trees	Trees/Plot	Ring-Count Trees
WH	190	560	6.0	0
DF	45	56	0.6	1
RA	6	6	0.1	0
RC	1	1	0.0	0
ALL	242	623	6.6	1

Unit Cruise Statistics: STAIRWAY TO HEMLOCK U3

Sp	BA (sq ft/acre)	BA CV (%)	BA SE (%)	V-BAR (bf/sq ft)	V-BAR CV (%)	V-BAR SE (%)	Net Vol (bf/acre)	Vol CV (%)	Vol SE (%)
WH	279.6	38.5	4.0	187.3	19.9	1.4	52,381	43.3	4.2
DF	28.0	133.3	13.7	209.9	17.3	2.6	5,869	134.4	14.0
RA	3.0	599.5	61.8	114.3	20.3	8.3	342	599.8	62.4
RC	0.5	969.5	100.0	131.8	0.0	0.0	66	969.5	100.0
ALL	311.1	35.1	3.6	188.5	21.0	1.4	58,658	40.9	3.9

Unit Summary: STAIRWAY TO HEMLOCK U3

Sp	Status	Rx	N	D	DBH	BL	THT	BF Gross	BF Net	Defect %	TPA	BA	RD	MBF Net
DF	LIVE	CUT	45	ALL	26.5	103	133	6,324	5,869	7.2	7.3	28.0	5.4	563.4
RA	LIVE	CUT	6	ALL	14.9	62	79	381	342	10.0	2.5	3.0	0.8	32.9
RC	LIVE	CUT	1	ALL	16.0	71	89	66	66	0.0	0.4	0.5	0.1	6.3
WH	LIVE	CUT	190	ALL	18.6	88	112	54,736	52,381	4.3	148.2	279.6	64.8	5,028.6
ALL	LIVE	CUT	242	ALL	19.0	88	113	61,506	58,658	4.6	158.4	311.1	71.2	5,631.2
ALL	ALL	ALL	242	ALL	19.0	88	113	61,506	58,658	4.6	158.4	311.1	71.2	5,631.2

Cruise Unit Report STAIRWAY TO HEMLOCK U4 ROW

Unit Sale Notice Volume (MBF): STAIRWAY TO HEMLOCK U4 ROW

Sp	DBH	Rings/In	Age	MBF Volume by Grade				
				All	2 Saw	3 Saw	4 Saw	Utility
WH	20.7			60	42	14	4	
DF	13.6			8	6		2	
RA	16.6			8	3	3	2	
MA	9.0			2				2
ALL	16.7			78	51	16	9	2

Unit Cruise Design: STAIRWAY TO HEMLOCK U4 ROW

Design	Cruise Acres	FMA Acres	N Plots	N Cruise Plots	N Void Plots
B1: VR, 1 BAF (46.94) Measure All, Sighting Ht = 4.5 ft	2.0	1.5	3	3	0

Unit Cruise Summary: STAIRWAY TO HEMLOCK U4 ROW

Sp	Cruised Trees	All Trees	Trees/Plot	Ring-Count Trees
WH	10	10	3.3	0
DF	2	2	0.7	0
RA	2	2	0.7	0
MA	1	1	0.3	0
ALL	15	15	5.0	0

Unit Cruise Statistics: STAIRWAY TO HEMLOCK U4 ROW

Sp	BA (sq ft/acre)	BA CV (%)	BA SE (%)	V-BAR (bf/sq ft)	V-BAR CV (%)	V-BAR SE (%)	Net Vol (bf/acre)	Vol CV (%)	Vol SE (%)
WH	156.5	105.4	60.8	191.4	20.8	6.6	29,943	107.4	61.2
DF	31.3	86.6	50.0	131.1	64.2	45.4	4,102	107.8	67.5
RA	31.3	173.2	100.0	125.5	1.8	1.3	3,928	173.2	100.0
MA	15.6	173.2	100.0	54.3	0.0	0.0	850	173.2	100.0
ALL	234.7	60.0	34.6	165.4	34.7	9.0	38,823	69.3	35.8

Unit Summary: STAIRWAY TO HEMLOCK U4 ROW

Sp	Status	Rx	N	D	DBH	BL	THT	BF Gross	BF Net	Defect %	TPA	BA	RD	MBF Net
DF	LIVE	CUT	2	ALL	13.6	42	60	4,131	4,102	0.7	31.0	31.3	8.5	8.2
MA	LIVE	CUT	1	ALL	9.0	23	32	850	850	0.0	35.4	15.6	5.2	1.7
RA	LIVE	CUT	2	ALL	16.6	83	101	4,998	3,928	21.4	20.8	31.3	7.7	7.9
WH	LIVE	CUT	10	ALL	20.7	89	113	30,312	29,943	1.2	67.0	156.5	34.4	59.9
ALL	LIVE	CUT	15	ALL	16.7	64	82	40,290	38,823	3.6	154.2	234.7	55.8	77.6
ALL	ALL	ALL	15	ALL	16.7	64	82	40,290	38,823	3.6	154.2	234.7	55.8	77.6



Forest Practices Application/Notification
Notice of Decision

FPA/N No: 2942067

Effective Date: 12/14/2023

Expiration Date: 12/14/2026

Shut Down Zone: 651S ;

EARR Tax Credit: [X] Eligible [] Non-eligible

Reference: Stairway to Hemlock

30-087001

Decision

- [] Notification Accepted Operations shall not begin before the effective date.
[X] Approved This Forest Practices Application is subject to the conditions listed below.
[] Disapproved This Forest Practices Application is disapproved for the reasons listed below.
[] Withdrawn Applicant has withdrawn the Forest Practices Application/Notification (FPA/N).
[] Closed All forest practices obligations are met.

FPA/N Classification

Number of Years Granted on Multi-Year Request

- [] Class II [X] Class III [] Class IVG [] Class IVS [] 4 years [] 5 years

Conditions on Approval/Reasons for Disapproval

No additional conditions.

Issued By: Brian Wesemann Region: Pacific Cascade Region

Title: Forest Practices Forester Date: 12/14/2023

Copies to: [] Landowner, Timber Owner, and Operator

Issued in person: [X] LO [X] TO [X] OP By: Jacqui Spahr Date: 12/14/2023

ROAD PLAN MAP

SALE NAME: STAIRWAY TO HEMLOCK
AGREEMENT#: 30-087001
TOWNSHIP(S): T9R5W
TRUST(S): Capitol Grant (7), Scientific School (10)

REGION: Pacific Cascade Region
COUNTY(S): Wahkiakum
ELEVATION RGE: 811-1258

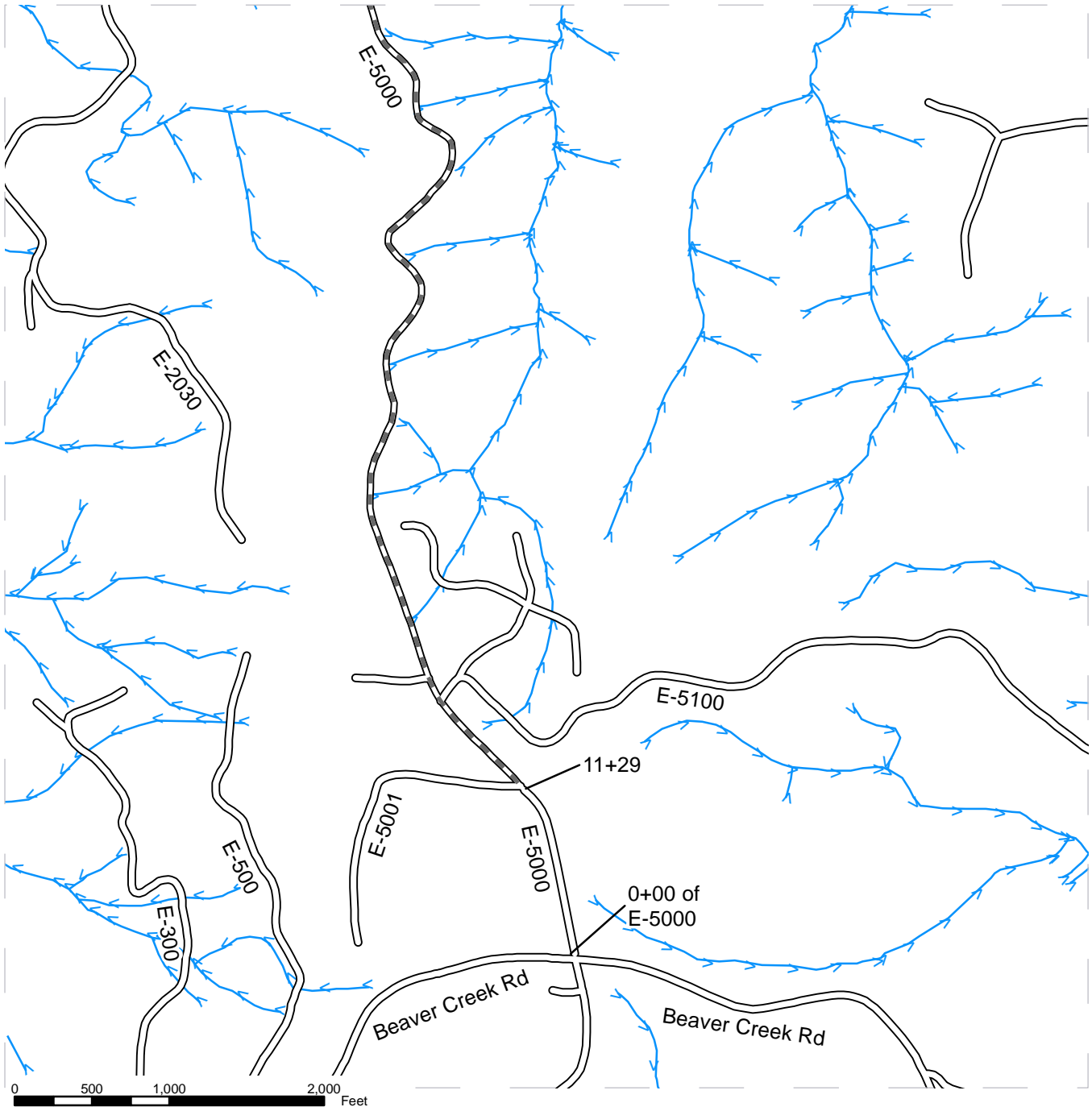

Legend:

- Existing Roads
- Required Pre-Haul Maintenance
- Streams

North arrow pointing up.

ROAD PLAN MAP

SALE NAME: STAIRWAY TO HEMLOCK
AGREEMENT#: 30-087001
TOWNSHIP(S): T9R5W
TRUST(S): Capitol Grant (7), Scientific School (10)

REGION: Pacific Cascade Region
COUNTY(S): Wahkiakum
ELEVATION RGE: 811-1258

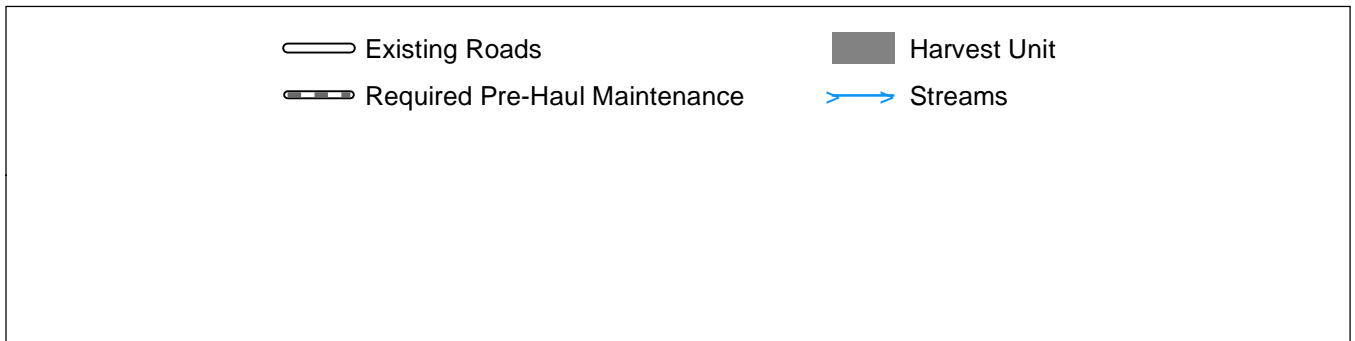
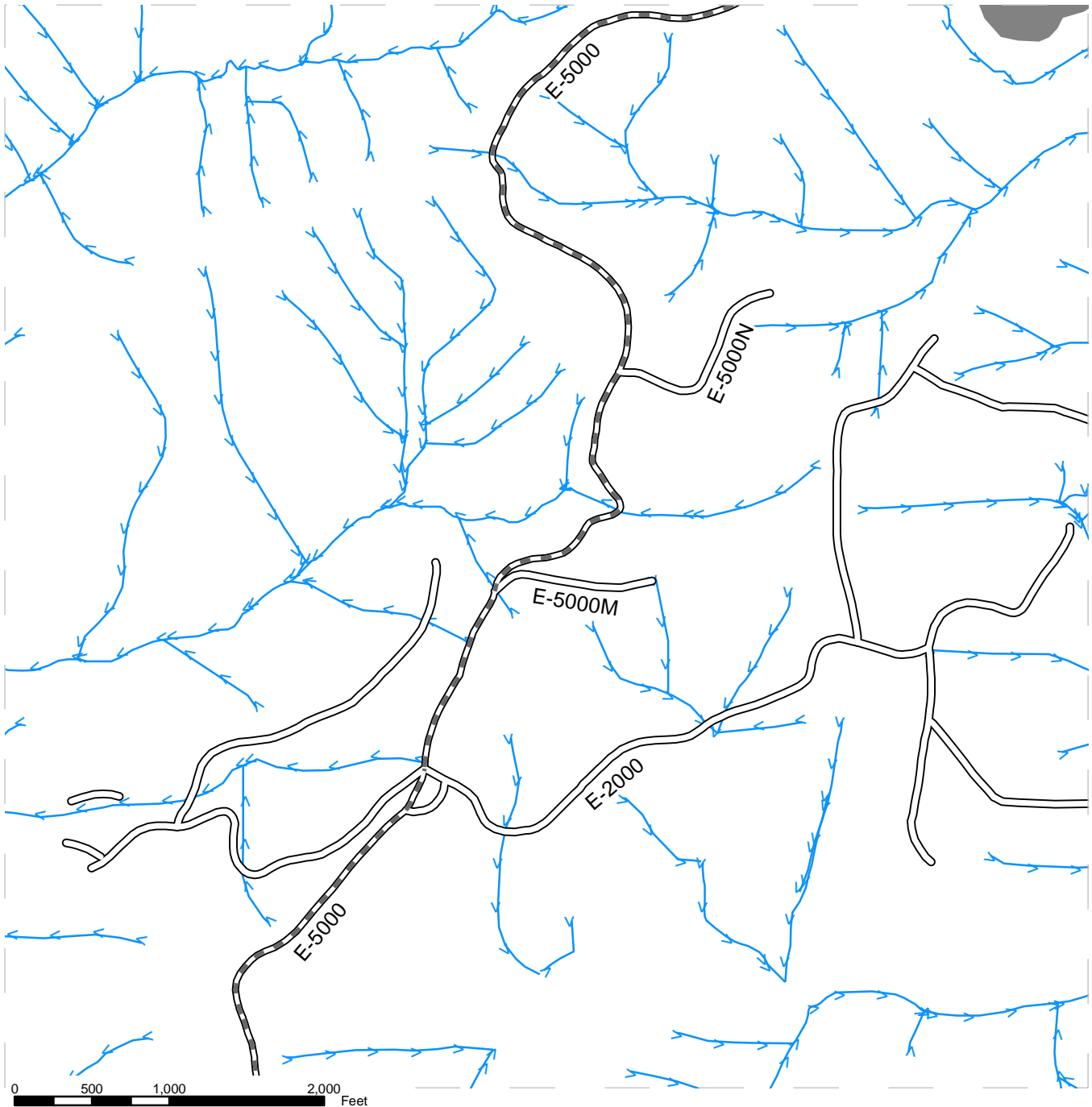

ROAD PLAN MAP

SALE NAME: STAIRWAY TO HEMLOCK
AGREEMENT#: 30-087001
TOWNSHIP(S): T9R5W
TRUST(S): Capitol Grant (7), Scientific School (10)

REGION: Pacific Cascade Region
COUNTY(S): Wahkiakum
ELEVATION RGE: 811-1258

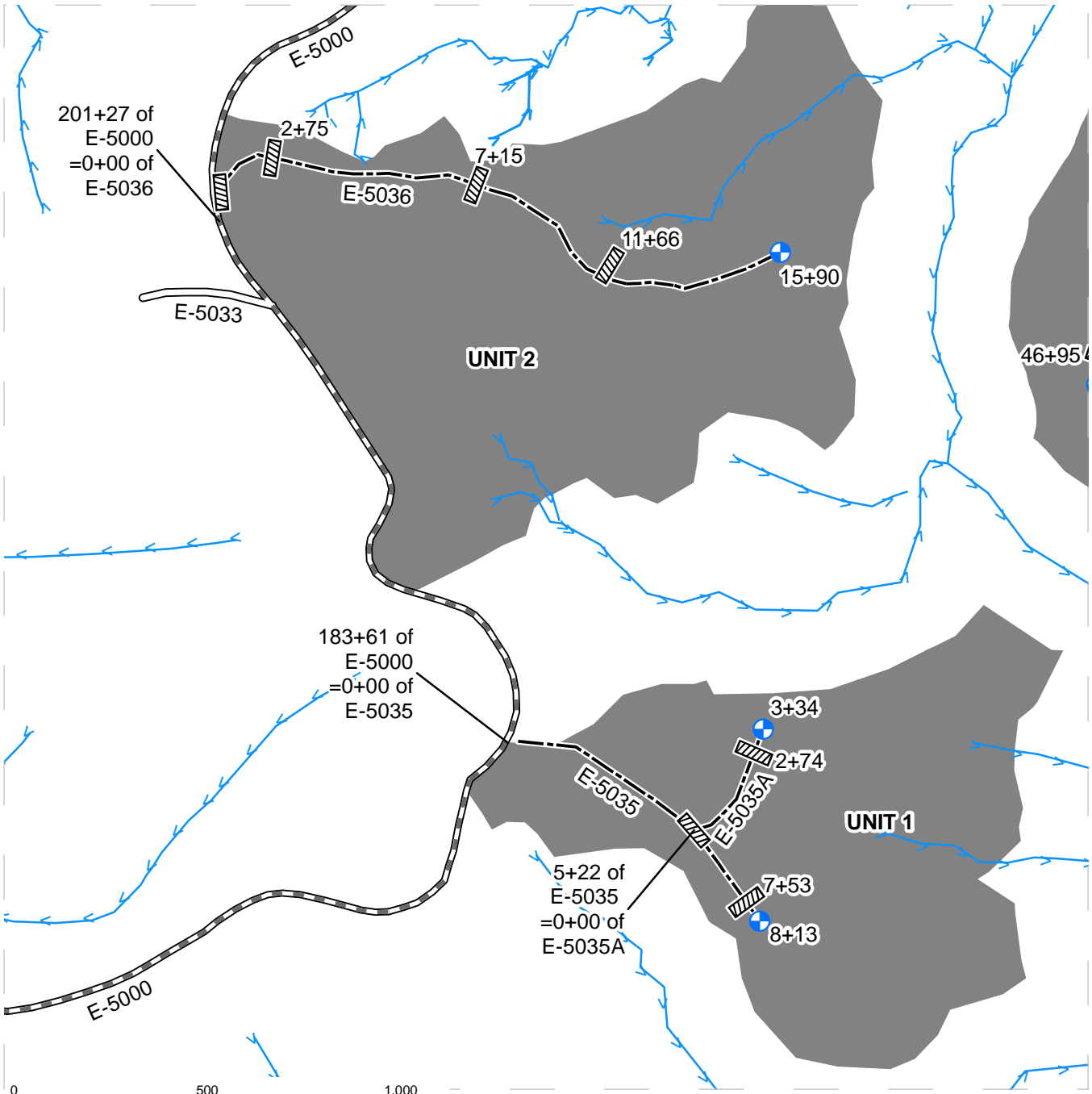

Existing Roads	Culvert	Harvest Unit
Required Pre-Haul Maintenance	Landing - Proposed	Streams
Optional Construction		



ROAD PLAN MAP

SALE NAME: STAIRWAY TO HEMLOCK
AGREEMENT#: 30-087001
TOWNSHIP(S): T9R5W
TRUST(S): Capitol Grant (7), Scientific School (10)

REGION: Pacific Cascade Region
COUNTY(S): Wahkiakum
ELEVATION RGE: 811-1258

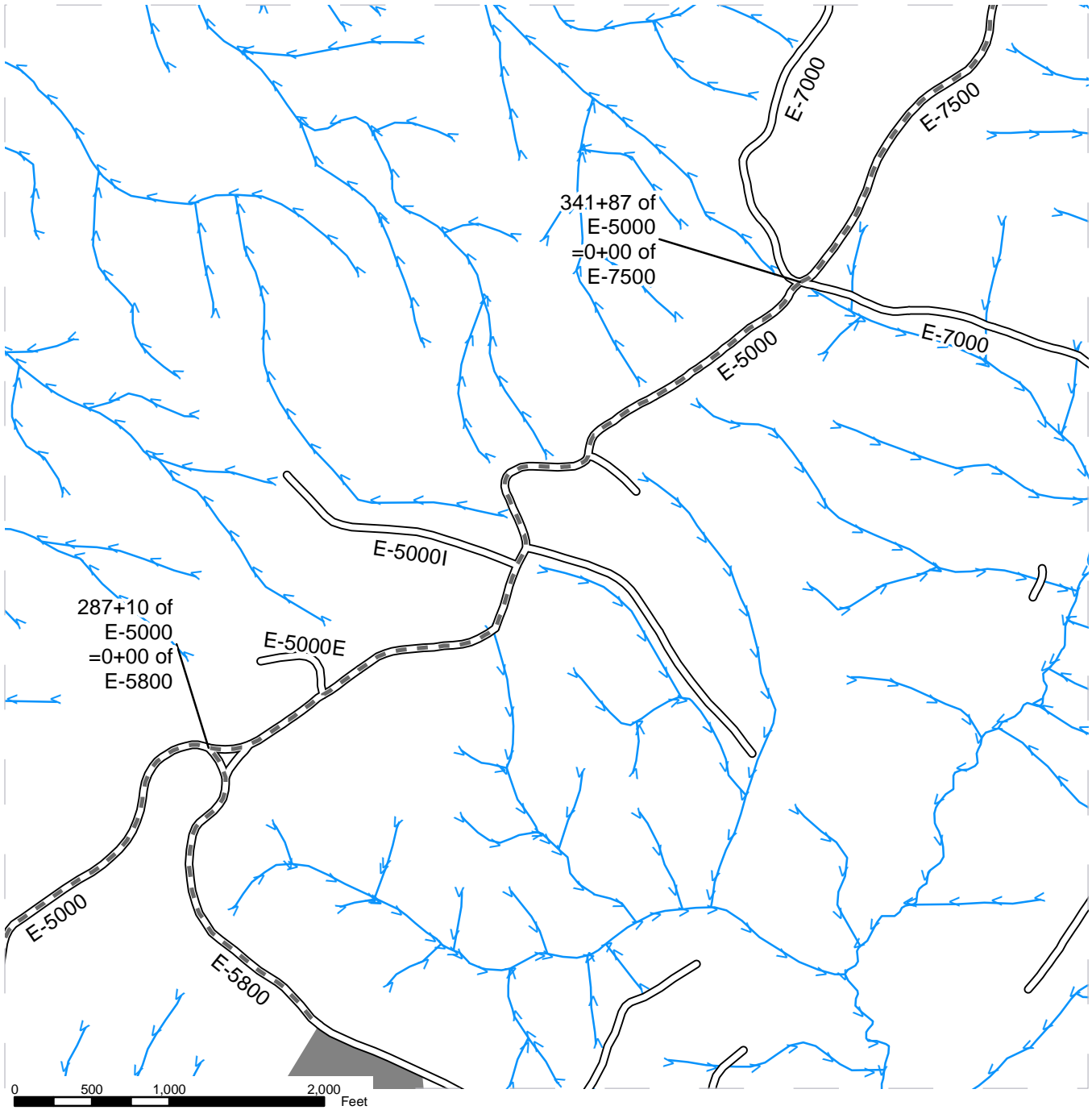

Existing Roads	Harvest Unit
Required Pre-Haul Maintenance	Streams



ROAD PLAN MAP

SALE NAME: STAIRWAY TO HEMLOCK
AGREEMENT#: 30-087001
TOWNSHIP(S): T9R5W
TRUST(S): Capitol Grant (7), Scientific School (10)

REGION: Pacific Cascade Region
COUNTY(S): Wahkiakum
ELEVATION RGE: 811-1258

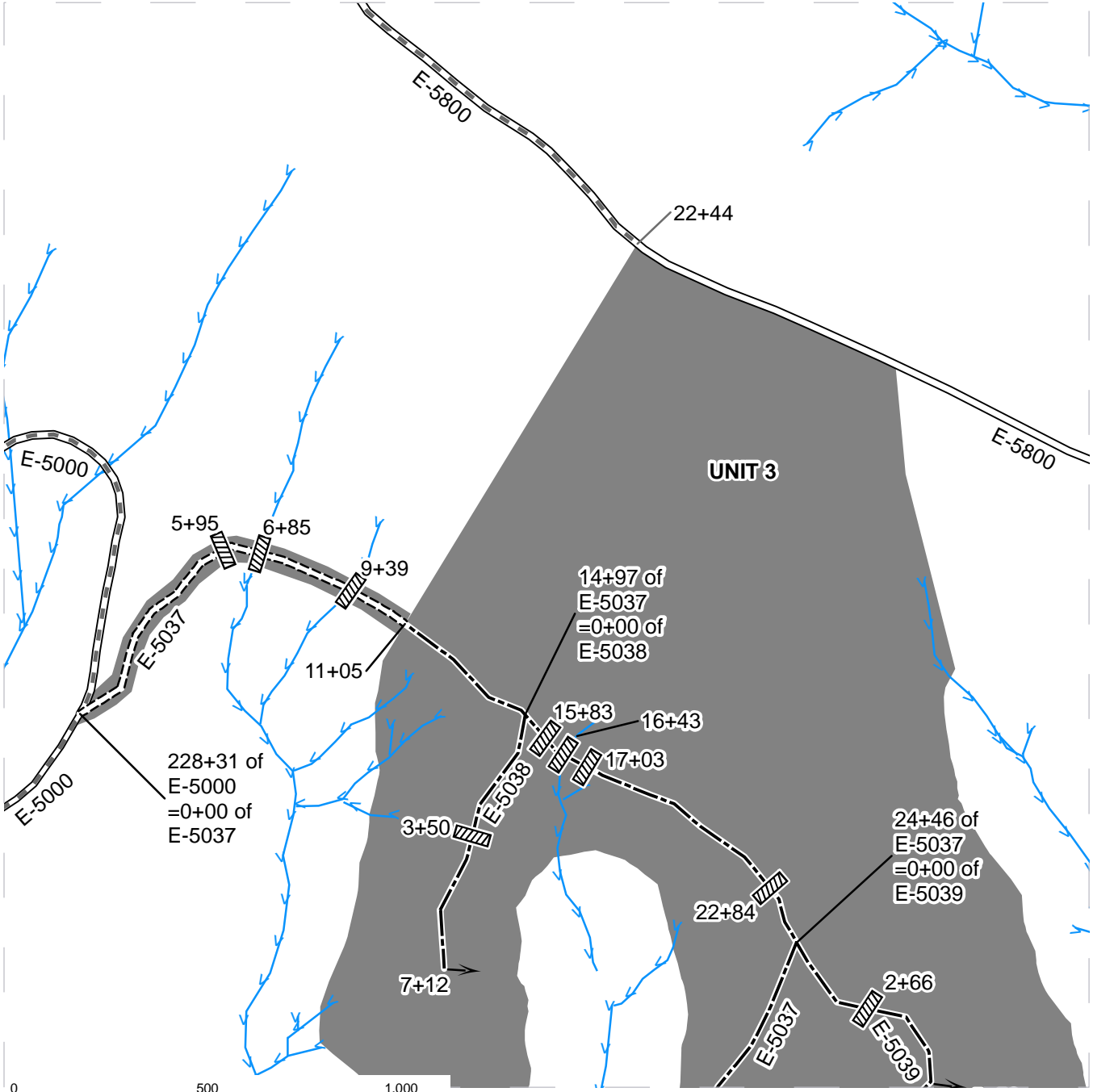

Existing Roads	Ditchout	Harvest Unit
Required Pre-Haul Maintenance	Culvert	Streams
Required Construction		
Optional Construction		



ROAD PLAN MAP

SALE NAME: STAIRWAY TO HEMLOCK
AGREEMENT#: 30-087001
TOWNSHIP(S): T9R5W
TRUST(S): Capitol Grant (7), Scientific School (10)

REGION: Pacific Cascade Region
COUNTY(S): Wahkiakum
ELEVATION RGE: 811-1258

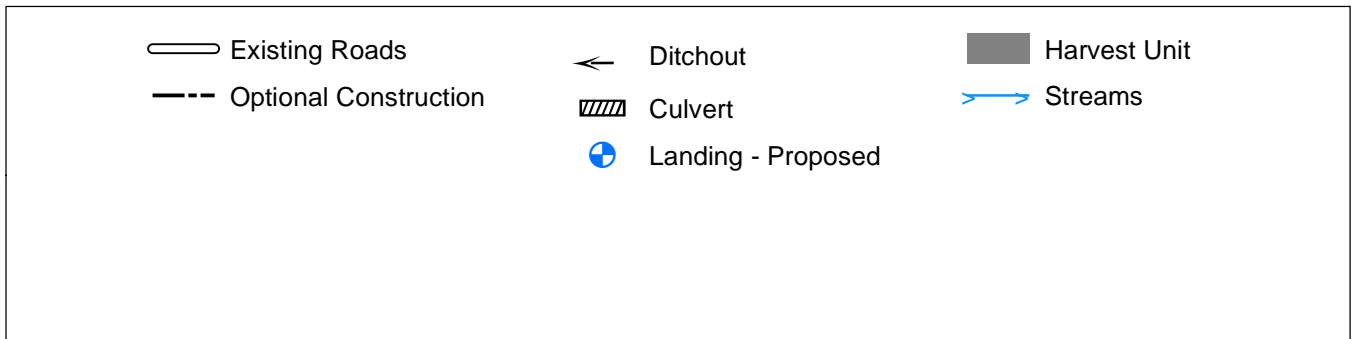
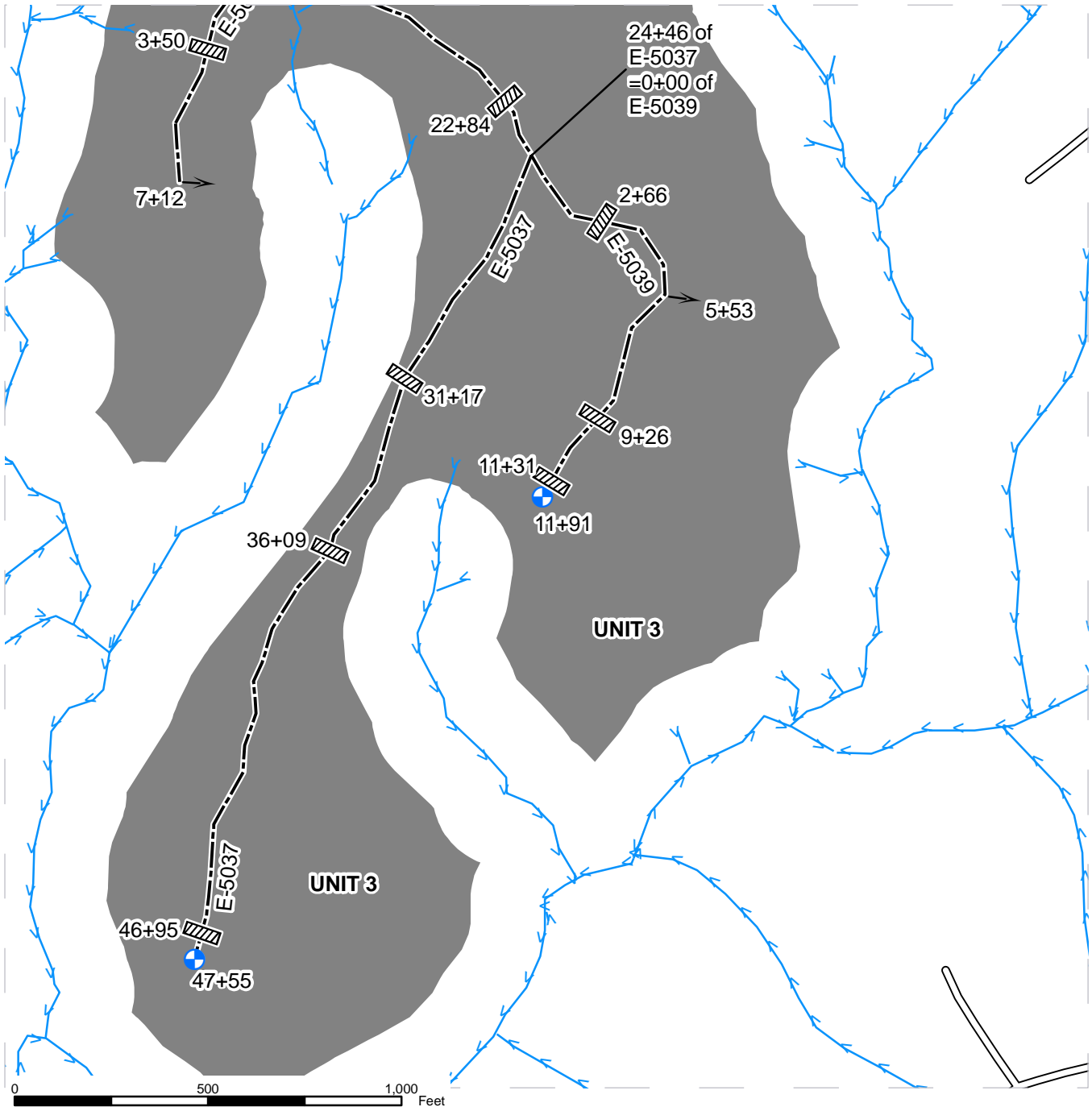

ROAD PLAN MAP

SALE NAME: STAIRWAY TO HEMLOCK
AGREEMENT#: 30-087001
TOWNSHIP(S): T9R5W
TRUST(S): Capitol Grant (7), Scientific School (10)

REGION: Pacific Cascade Region
COUNTY(S): Wahkiakum
ELEVATION RGE: 811-1258

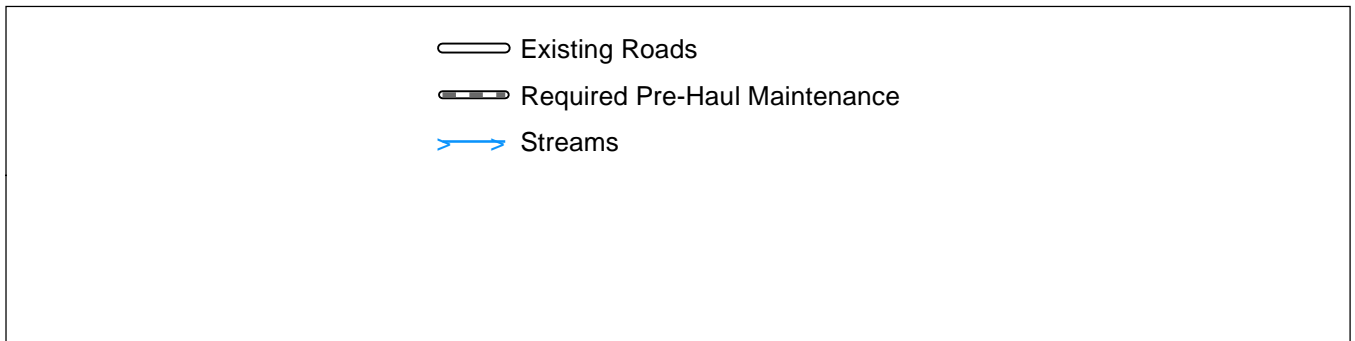
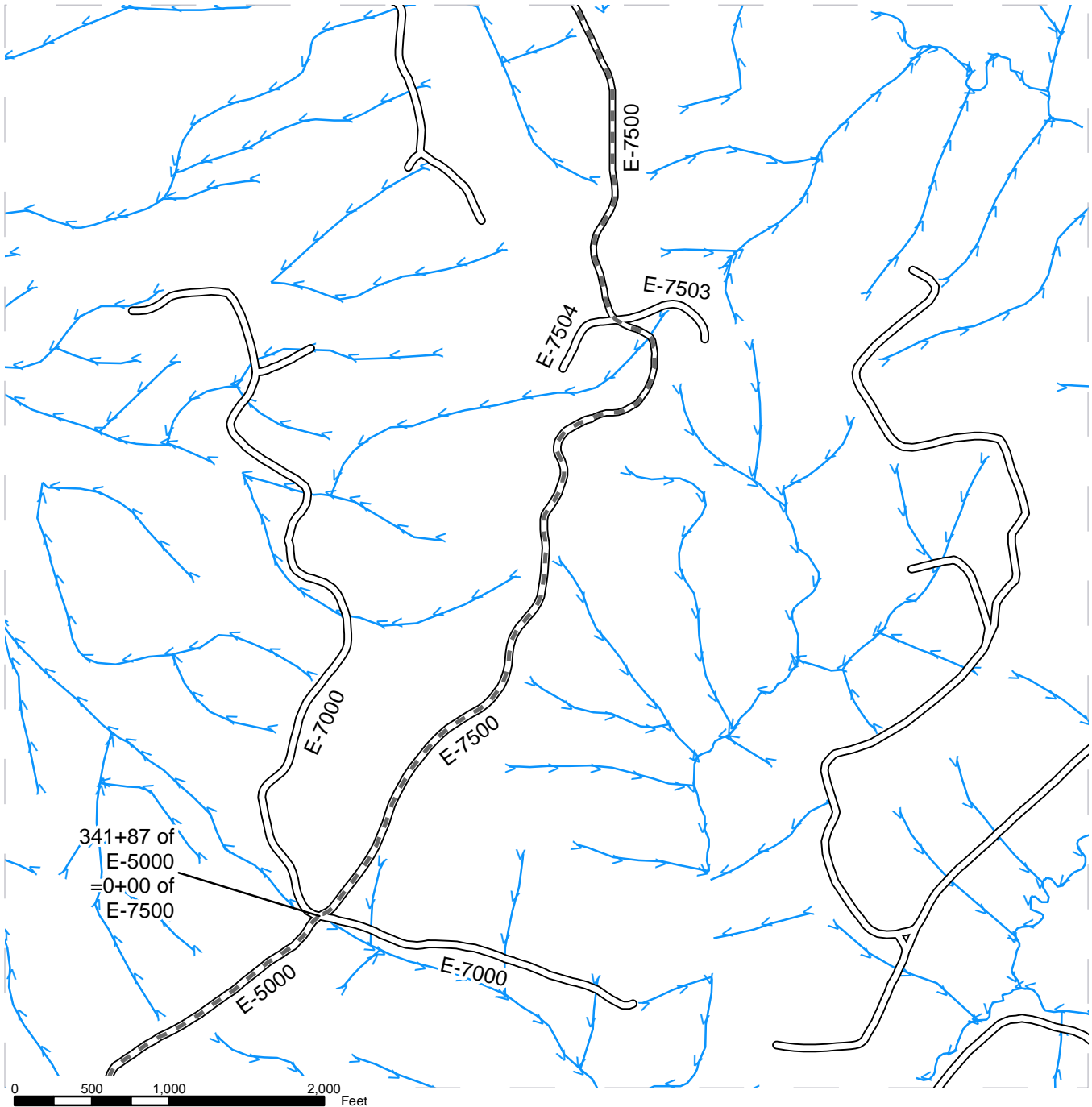

ROAD PLAN MAP

SALE NAME: STAIRWAY TO HEMLOCK
AGREEMENT#: 30-087001
TOWNSHIP(S): T9R5W
TRUST(S): Capitol Grant (7), Scientific School (10)

REGION: Pacific Cascade Region
COUNTY(S): Wahkiakum
ELEVATION RGE: 811-1258

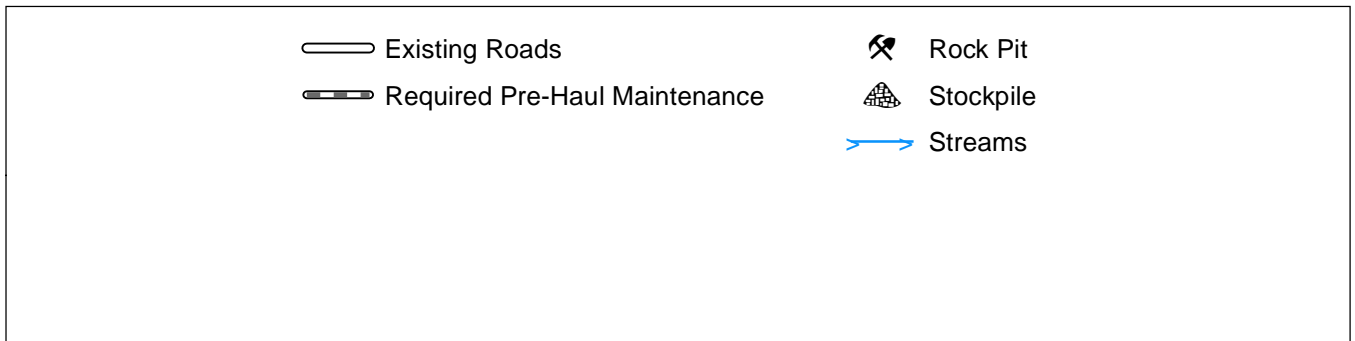
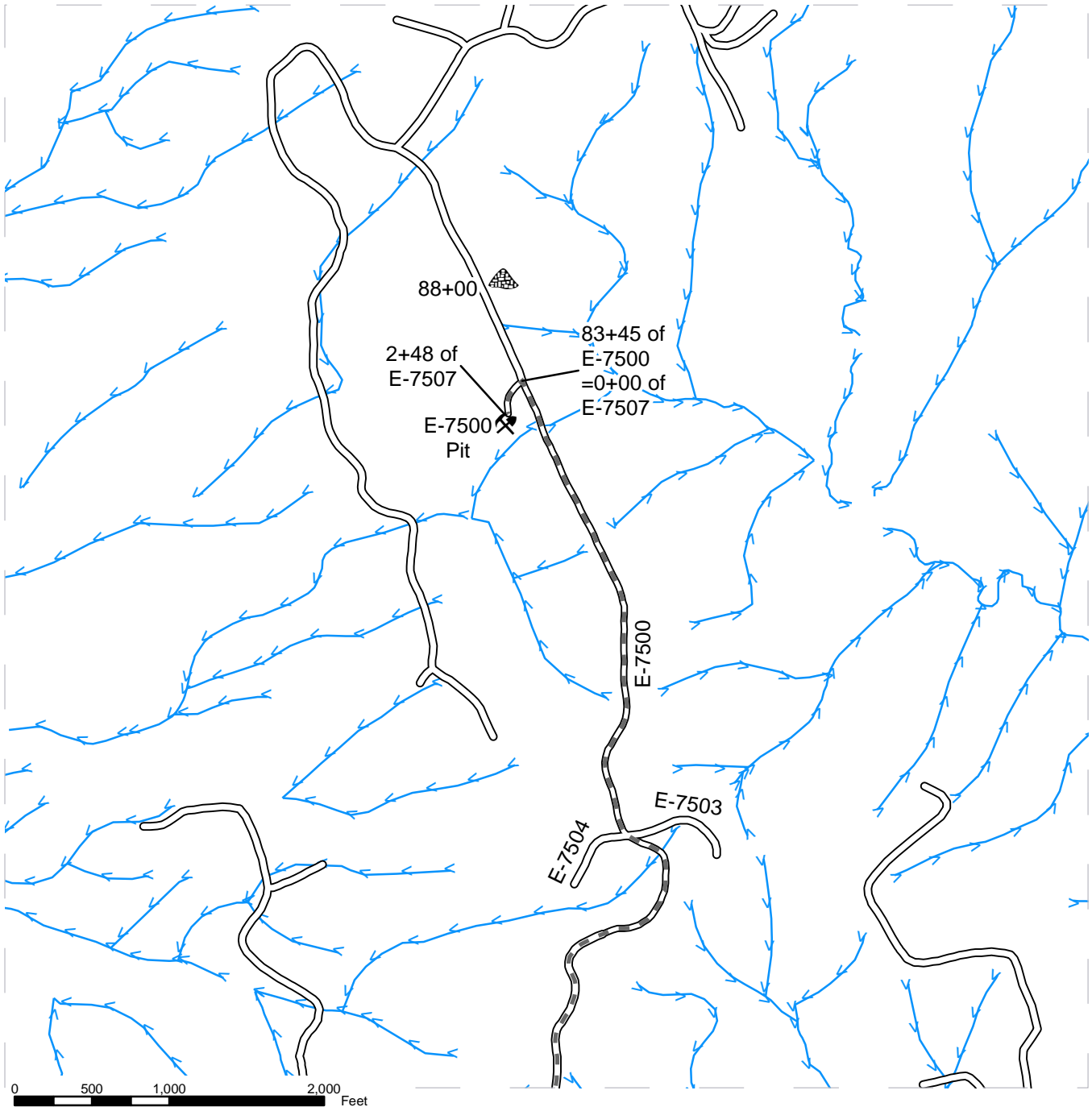

STATE OF WASHINGTON
DEPARTMENT OF NATURAL RESOURCES

STAIRWAY TO HEMLOCK TIMBER SALE ROAD PLAN
WAHKIAKUM COUNTY
ST HELENS DISTRICT
PACIFIC CASCADE REGION

AGREEMENT NO.: 30-087001

STAFF ENGINEER: CHACE JOHANSON

DRAWN & COMPILED BY: ALICIA COMPTON

SECTION 0 – SCOPE OF PROJECT

0-1 ROAD PLAN SCOPE

Clauses in this road plan apply to all road related work, including landings and rock source development, unless otherwise noted.

0-2 REQUIRED ROADS

The specified work on the following roads is required.

<u>Road</u>	<u>Stations</u>	<u>Type</u>
E-5000	11+29 to 341+87	Pre-Haul Maintenance
E-5800	0+00 to 22+44	
E-7500	0+00 to 83+45	
E-7507	0+00 to 2+48	
E-5037	0+00 to 11+05	Construction

0-3 OPTIONAL ROADS

The specified work on the following roads is not required. Any optional roads built by the Purchaser must meet all the specifications in the road plan.

<u>Road</u>	<u>Stations</u>	<u>Type</u>
E-5035	0+00 to 8+13	Construction
E-5035A	0+00 to 3+34	
E-5036	0+00 to 15+90	
E-5037	11+05 to 47+55	
E-5038	0+00 to 7+12	
E-5039	0+00 to 11+91	

0-4 CONSTRUCTION

This project includes, but is not limited to the following construction requirements:

<u>Road</u>	<u>Requirements</u>
E-5035	Clearing, grubbing, and organic debris disposal; excavation, embankment, fill, and waste material disposal; turnout, landing, turnaround, ditch, and ditch-out construction; acquisition and installation of drainage structures; shaping and compaction; manufacture, and application of rock; acquisition and application of erosion control.
E-5035A	
E-5036	
E-5037	
E-5038	
E-5039	

0-6 PRE-HAUL MAINTENANCE

This project includes, but is not limited to the following pre-haul maintenance requirements:

<u>Road</u>	<u>Requirements</u>
E-5000	Maintenance grading, rock, compaction
E-5800	
E-7500	
E-7507	

0-12 DEVELOP ROCK SOURCE

Purchaser shall develop an existing rock source. Rock source development will involve clearing, grubbing, organic debris disposal, stripping overburden, waste material disposal, ripping, drilling, blasting, pre-screening, etc. Work for developing rock sources is listed in Section 6 ROCK AND SURFACING.

SECTION 1 – GENERAL

1-1 ROAD PLAN CHANGES

If the Purchaser desires a change from this road plan including, but not limited to, relocation, extension, change in design, or adding roads; a revised road plan must be submitted in writing to the Contract Administrator for consideration. Before work begins, Purchaser shall obtain approval from the State for the submitted plan.

1-2 UNFORESEEN CONDITIONS

Quantities established in this road plan are minimum acceptable values. Additional quantities required by the state due to unforeseen conditions, or Purchaser's choice of construction season or techniques will be at the Purchaser's expense. Unforeseen conditions include, but are not limited to, solid subsurface rock, subsurface springs, saturated ground, and unstable soils.

1-3 ROAD DIMENSIONS

Purchaser shall perform road work in accordance with the dimensions shown on the TYPICAL SECTION SHEET and the specifications within this road plan.

1-4 ROAD TOLERANCES

Purchaser shall perform road work within the tolerances listed below. The tolerance class for each road is listed on the TYPICAL SECTION SHEET.

<u>Tolerance Class</u>	<u>A</u>	<u>B</u>	<u>C</u>
Road and Subgrade Width (feet)	+1.5	+1.5	+2.0
Subgrade Elevation (feet +/-)	0.5	1.0	2.0
Centerline alignment (feet lt./rt.)	1.0	1.5	3.0

1-6 ORDER OF PRECEDENCE

Any conflict or inconsistency in the road plan will be resolved by giving the documents precedence in the following order:

1. Addenda.
2. Designs or Plans. On designs and plans, figured dimensions shall take precedence over scaled dimensions.
3. Road Plan Clauses.
4. Typical Section Sheet.
5. Standard Lists.
6. Standard Details.
7. Road Plan maps.

In case of any ambiguity or dispute over interpreting the road plan, the Contract Administrator’s or designee’s decision will be final.

1-8 REPAIR OR REPLACEMENT OF DAMAGED MATERIALS

Purchaser shall repair or replace all materials, roadway infrastructure, and road components damaged during road work or operation activities. The Contract Administrator will direct repairs and replacements. Repairs to structural materials must be made in accordance with the manufacturer’s recommendation and may not begin without written approval from the Contract Administrator.

1-9 DAMAGED METALLIC COATING

Any cut ends, or damaged galvanized or aluminized coating on existing or new bridge components, culverts, downspouts, and flumes must be cleaned and treated with a minimum of two coats of zinc rich paint or cold galvanizing compound.

1-15 ROAD MARKING

Purchaser shall perform road work in accordance with the state’s marked location. All road work is marked as follows:

- Stakes, orange ribbon, orange paint, ROW tags for new construction
- Orange paint or orange ribbon for pre-haul maintenance

1-18 REFERENCE POINT DAMAGE

Purchaser shall reset reference points (RPs) that were moved or damaged at any time during construction to their original locations. Excavation and embankment may not proceed on road segments controlled by said RPs until Purchaser resets all moved or damaged RPs.

1-21 HAUL APPROVAL

Purchaser shall not use roads under this road plan for timber haul, other than timber cut on the right-of-way, without written approval from the Contract Administrator.

1-22 WORK NOTIFICATIONS

Purchaser shall notify the Contract Administrator a minimum of 3 business days before work begins.

1-23 ROAD WORK PHASE APPROVAL

Purchaser shall obtain written approval from the Contract Administrator upon completion of each of the following phases of road work:

- Maintenance grading
- Subgrade construction and reconstruction
- Culvert installations
- Shaping & compaction
- Rock application & compaction
- Post-construction and reconstruction erosion control application

1-25 ACTIVITY TIMING RESTRICTION

The specified activities are not allowed during the listed closure period(s) unless authorized in writing by the Contract Administrator.

<u>Activity</u>	<u>Closure Period</u>
Road Construction	October 1 to April 30

1-26 OPERATING DURING CLOSURE PERIOD

If permission is granted to operate during a closure period listed in Clause 1-25 ACTIVITY TIMING RESTRICTION, Purchaser shall provide a maintenance plan to include further protection of state resources. Purchaser shall obtain written approval from the Contract Administrator for the maintenance plan, and shall put preventative measures in place before operating during the closure period. Purchaser is required to maintain all haul roads at their own expense.

1-29 SEDIMENT RESTRICTION

Purchaser shall not allow silt-bearing runoff to enter any streams.

1-30 CLOSURE TO PREVENT DAMAGE

In accordance with Contract Clause G-220 STATE SUSPENDS OPERATION, the Contract Administrator will suspend road work or hauling right-of-way timber, forest products, or rock under the following conditions:

- Wheel track rutting exceeds 6 inches on jaw run or pit run roads.
- Wheel track rutting exceeds 4 inches on crushed rock roads.
- Wheel track rutting exceeds 8 inches on native surface roads.
- Surface or base stability problems persist.
- Weather is such that satisfactory results cannot be obtained in an area of operations.
- When, in the opinion of the Contract Administrator excessive road damage or rutting may occur.

Operations must stop unless authority to continue working or hauling is granted in writing by the Contract Administrator. In the event that surface or base stability problems persist, Purchaser shall cease operations, or perform corrective maintenance or repairs, subject to specifications within this road plan. Before and during any suspension, Purchaser shall protect the work from damage or deterioration.

1-32 BRIDGE OR ASPHALT SURFACE RESTRICTION

The use of metal tracked equipment is not allowed on bridge or asphalt surfaces at any time. If Purchaser must run equipment on bridge or asphalt surfaces, then rubber tired equipment or other methods, approved in writing by Contract Administrator, must be used.

If tracked equipment is used on bridge or asphalt surfaces, Purchaser shall immediately cease all road construction and hauling operations. Purchaser shall remove any dirt, rock, or other material tracked or spilled on the bridge or asphalt surface(s) and have surface(s) evaluated by the Contract Administrator or their designee for any damage caused by transporting equipment. Any damage to the surface(s) will be repaired, at the Purchaser's expense, as directed by the Contract Administrator.

1-33 SNOW PLOWING RESTRICTION

Snowplowing will be allowed after the execution of a SNOW PLOWING AGREEMENT, which is available from the Contract Administrator upon request. Purchaser shall request a SNOW PLOWING AGREEMENT each time plowing occurs. If damage occurs while plowing, further permission to plow may be revoked by the Contract Administrator.

1-40 ROAD APPROACHES TO COUNTY ROADS AND STATE HIGHWAYS

Purchaser shall immediately remove any mud, dirt, rock, or other material tracked or spilled on to county roads and state highways.

If additional damage to the surface, signs, guardrails, etc. occurs then the damage will be repaired, at the Purchaser's expense, as directed by the Contract Administrator when authorized by the county or WSDOT.

SECTION 2 – MAINTENANCE

2-1 GENERAL ROAD MAINTENANCE

Purchaser shall maintain all roads used under this contract in accordance with the FOREST ACCESS ROAD MAINTENANCE SPECIFICATIONS for the entire term of this contract. Maintenance is required even during periods of inactivity.

2-2 ROAD MAINTENANCE – PURCHASER MAINTENANCE

Purchaser shall perform maintenance on roads listed in Contract Clause C-050 PURCHASER ROAD MAINTENANCE AND REPAIR in accordance with FOREST ACCESS ROAD MAINTENANCE SPECIFICATIONS.

2-3 ROAD MAINTENANCE – DESIGNATED MAINTAINER

Purchaser may be required to perform maintenance on roads listed in Contract Clause C-060 DESIGNATED ROAD MAINTAINER as directed by the Contract Administrator. Purchaser shall maintain roads in accordance with FOREST ACCESS ROAD MAINTENANCE SPECIFICATIONS.

2-4 PASSAGE OF LIGHT VEHICLES

Purchaser shall maintain all road(s) in a condition that will allow the passage of light administrative vehicles.

2-5 MAINTENANCE GRADING – EXISTING ROAD

On the following road(s), Purchaser shall use a grader to shape the existing surface before rock application.

<u>Road</u>	<u>Stations</u>	<u>Requirements</u>
E-5000	11+29 to 341+87	Grade, shape, apply specified rock per ROCK LIST, compact
E-5800	0+00 to 22+44	
E-7500	0+00 to 83+45	
E-7507	0+00 to 2+48	

SECTION 3 – CLEARING, GRUBBING, AND DISPOSAL

3-5 CLEARING

Purchaser shall fall all vegetative material larger than 2 inches DBH or over 5 feet high between the marked right-of-way boundaries and within waste and debris areas, or if not marked in the field, between the clearing limits specified on the TYPICAL SECTION SHEET. Clearing must be completed before starting excavation and embankment.

3-8 PROHIBITED DECKING AREAS

Purchaser shall not deck right-of-way timber in the following areas:

- Within the grubbing limits.
- Within 25 feet of any stream.
- In locations that interfere with the construction of the road prism.
- In locations that impede drainage.
- On slopes greater than 45%.
- Against standing trees.

3-10 GRUBBING

Purchaser shall remove all stumps between the grubbing limits specified on the TYPICAL SECTION SHEET. Purchaser shall also remove stumps with undercut roots outside the grubbing limits. Purchaser shall remove stumps using a hydraulic mounted excavator unless authorized in writing by the Contract Administrator. Grubbing must be completed before starting excavation and embankment.

3-12 STUMP PLACEMENT

Purchaser shall place grubbed stumps outside of the grubbing limits, on the downhill side of the road, and in compliance with all other clauses in this road plan.

3-20 ORGANIC DEBRIS DEFINITION

Organic debris is defined as all vegetative material not eligible for removal by Contract Clause G-010 PRODUCTS SOLD AND SALE AREA or G-011 RIGHT TO REMOVE FOREST PRODUCTS AND CONTRACT AREA, that is larger than one cubic foot in volume.

3-21 DISPOSAL COMPLETION

Purchaser shall remove organic debris from the road surface, ditchlines, and culvert inlets and outlets. Purchaser shall complete all disposal of organic debris, except by burning, before timber haul.

3-23 PROHIBITED DISPOSAL AREAS

Purchaser shall not place organic debris in the following areas:

- Within 25 feet of a cross drain culvert.
- Within 50 feet of a live stream, or wetland.
- On road subgrades, or excavation and embankment slopes.
- On slopes greater than 45%.
- Within the operational area for cable landings where debris may shift or roll.
- On locations where brush can fall into the ditch or onto the road surface.
- Against standing timber.
- On the uphill side of the road.

3-24 BURYING ORGANIC DEBRIS RESTRICTED

Purchaser shall not bury organic debris unless otherwise stated in this plan.

3-25 SCATTERING ORGANIC DEBRIS

Contractor shall scatter organic debris outside of the grubbing limits on the downhill side of the road, unless otherwise detailed in this road plan, or as directed by the Contract Administrator.

SECTION 4 – EXCAVATION

4-2 PIONEERING

Pioneering may not extend past construction that will be completed during the current construction season. In addition, the following actions must be taken as pioneering progresses:

- Drainage must be provided on all uncompleted construction.
- Road pioneering operations may not undercut the final cut slope or restrict drainage.
- Culverts at live stream crossings must be installed during pioneering operations prior to embankment.

4-3 ROAD GRADE AND ALIGNMENT STANDARDS

Purchaser shall follow these standards for road grade and alignment:

- Grade and alignment must have smooth continuity, without abrupt changes in direction.
- Maximum grades may not exceed 18 percent favorable and 12 percent adverse.
- Minimum curve radius is 60 feet at centerline.
- Maximum grade change for sag vertical curves is 12% in 100 feet.
- Maximum grade change for crest vertical curves is 8% in 100 feet.

4-5 CUT SLOPE RATIO

Purchaser shall construct excavation slopes no steeper than shown on the following table:

<u>Material Type</u>	<u>Excavation Slope Ratio</u>	<u>Excavation Slope Percent</u>
Common Earth (on side slopes up to 55%)	1:1	100
Fractured or loose rock	½:1	200
Hardpan or solid rock	¼:1	400

4-6 EMBANKMENT SLOPE RATIO

Purchaser shall construct embankment slopes no steeper than shown on the following table, unless construction staked or designed:

<u>Material Type</u>	<u>Embankment Slope Ratio</u>	<u>Embankment Slope Percent</u>
Sandy Soils	2:1	50
Common Earth and Rounded Gravel	1½:1	67
Angular Rock	1¼:1	80

4-7 SHAPING CUT AND FILL SLOPE

Purchaser shall construct excavation and embankment slopes to a uniform line and left rough for easier revegetation.

4-8 CURVE WIDENING

The minimum widening placed on the inside of curves is:

- 6 feet for curves of 50 to 79 feet radius.
- 4 feet for curves of 80 to 100 feet radius.

4-21 TURNOUTS

Purchaser shall construct turnouts as designated on the ROCK LIST. Locations may be adjusted to fit the final subgrade alignment and sight distances. Location changes are subject to written approval by the Contract Administrator. Minimum dimensions are shown on the TYPICAL SECTION SHEET.

4-22 TURNAROUNDS

Purchaser shall construct optional turnarounds as designated on the ROCK LIST. Optional Turnarounds must be no larger than 30 feet long and 30 feet wide.

4-25 DITCH CONSTRUCTION AND RECONSTRUCTION

Purchaser shall construct ditches into the subgrade as specified on the TYPICAL SECTION SHEET. Ditches must be constructed concurrently with construction of the subgrade.

4-27 DITCH WORK – MATERIAL USE PROHIBITED

Purchaser shall not pull ditch material across the road or mix in with the road surface. Excavated material must be scattered outside the grubbing limits.

4-28 DITCH DRAINAGE

Ditches must drain to cross-drain culverts or ditchouts.

4-29 DITCHOUTS

Purchaser shall construct ditchouts as identified on the CULVERT LIST and as needed or as directed by the Contract Administrator. Ditchouts must be constructed in a manner that diverts ditch water onto the forest floor and must have excavation backslopes no steeper than a 1:1 ratio. L or R denotes ditchout left or ditchout right.

4-35 WASTE MATERIAL DEFINITION

Waste material is defined as all dirt, rock, mud, or related material that is extraneous or unsuitable for construction material. Waste material, as used in Section 4 EXCAVATION, is not organic debris.

4-36 DISPOSAL OF WASTE MATERIAL

Purchaser may sidecast waste material on side slopes up to 45% if the waste material is compacted and free of organic debris.

4-38 PROHIBITED WASTE DISPOSAL AREAS

Purchaser shall not deposit waste material in the following areas, except as otherwise specified in this plan:

- Within 25 feet of a cross drain culvert.
- Within 50 feet of a live stream or wetland.
- Within a riparian management zone.
- Within a wetland management zone.
- On side slopes steeper than 45%.
- In locations that interfere with the construction of the road prism.
- In locations that impede drainage.
- Against standing timber.
- On the uphill side of the road.

4-48 NATIVE MATERIAL

Native material consists of naturally occurring material that is free of organic debris, trash, and rocks greater than 4 inches in any dimension.

4-55 ROAD SHAPING

Purchaser shall shape the subgrade and surface as shown on the TYPICAL SECTION SHEET. The subgrade and surface shape must ensure runoff in an even, un-concentrated manner, and must be uniform, firm, and rut-free.

4-60 FILL COMPACTION

Purchaser shall compact all embankment and waste material in accordance with the COMPACTION LIST by routing equipment over the entire width of each lift. Waste material may be placed by end-dumping or sidecasting until sufficiently wide enough to support the equipment.

4-61 SUBGRADE COMPACTION

Purchaser shall compact constructed subgrades in accordance with the COMPACTION LIST by routing equipment over the entire width except ditch. Purchaser shall obtain written approval from the Contract Administrator for subgrade compaction before rocking or timber haul.

4-63 EXISTING SURFACE COMPACTION

Purchaser shall compact maintained road surfaces in accordance with the COMPACTION LIST by routing equipment over the entire width.

SECTION 5 – DRAINAGE

5-5 CULVERTS

Purchaser shall install culverts as part of this contract. Culverts must be installed concurrently with subgrade work and must be installed before subgrade compaction and rock application. Culvert locations and the minimum requirements for culvert length and diameter are designated on the CULVERT LIST. Culvert, downspout, and flume lengths may be adjusted to fit as-built conditions and may not terminate directly on unprotected soil. Culverts must be new material and meet the specifications in Clauses 10-17 through 10-22.

5-6 CULVERT TYPE

On all new roads, Purchaser shall install culverts made of plastic in accordance with Clauses 10-17 through 10-22.

5-10 CULVERT MARKER INSTALLATION

Purchaser shall provide and install culvert markers in accordance with the CULVERT AND DRAINAGE SPECIFICATION DETAIL at locations specifying culvert markers on the CULVERT LIST.

5-12 UNUSED MATERIALS STATE PROPERTY

On required roads, any materials listed on the CULVERT AND DRAINAGE LIST that are not installed will become the property of the state. Purchaser shall stockpile materials as directed by the Contract Administrator.

5-15 CULVERT INSTALLATION

Culvert installation must be in accordance with the CULVERT AND DRAINAGE SPECIFICATION DETAIL. Corrugated Polyethylene pipe must be installed in a manner consistent with the manufacturer's recommendations. Culverts shall be banded using lengths of no less than 10 feet, and no more than one length less than 20 feet. Shorter sections of banded culvert shall be installed at the inlet end.

5-17 CROSS DRAIN SKEW AND SLOPE

Cross drains, on road grades in excess of 3%, must be skewed at least 30 degrees from perpendicular to the road centerline, except where the cross drain is at the low point in the road culverts will not be skewed. Cross drain culverts must be installed at a slope steeper than the incoming ditch grade, but not less than 3% or more than 10%.

5-18 CULVERT DEPTH OF COVER

All culverts must be installed with a depth of cover of not less than 1 foot of compacted subgrade over the top of the culvert at the shallowest point.

5-20 ENERGY DISSIPATERS

Purchaser shall install energy dissipaters in accordance with the CULVERT AND DRAINAGE SPECIFICATION DETAIL at all culverts on the CULVERT LIST that specify the placement of rock at the outlet. Energy dissipater installation is subject to approval by the Contract Administrator.

The type of energy dissipater and the amount of material must be consistent with the specifications listed on the CULVERT LIST.

5-25 CATCH BASINS

Purchaser shall construct catch basins in accordance with CULVERT AND DRAINAGE SPECIFICATION DETAIL.

5-26 HEADWALLS FOR CROSS DRAIN CULVERTS

Purchaser shall construct headwalls in accordance with the CULVERT AND DRAINAGE SPECIFICATION DETAIL at all cross drain culverts on the CULVERT LIST that specify the placement of rock at the inlet. Rock may not restrict the flow of water into culvert inlets or catch basins. The type and quantity of rock used for headwalls shall be as specified on the CULVERT LIST.

5-27 ARMORING FOR STREAM CROSSING CULVERTS

Purchaser shall place inlet armor in conjunction with or immediately following construction of the embankment at culverts designated as stream crossings on the CULVERT LIST. The type of armor and the amount of material must be consistent with the specifications listed on the CULVERT LIST. Rock must be placed around culvert inlet. Rock may not restrict the flow of water into culvert inlets. Armor installation is subject to approval by the Contract Administrator.

SECTION 6 – ROCK AND SURFACING

6-2 ROCK SOURCE ON STATE LAND

Rock used in accordance with the quantities on the ROCK LIST may be obtained from the following source(s) on state land at no charge to the Purchaser. Purchaser shall obtain written approval from the Contract Administrator for the use of material from any other source. If other operators are using, or desire to use the rock source(s), a joint operating plan must be developed. All parties shall follow this plan. Purchaser shall notify the Contract Administrator a minimum of 3 business days before starting any operations in the listed locations.

<u>Source</u>	<u>Location</u>	<u>Rock Type</u>
7500 Pit	S01 T9N R5W	4-INCH JAW RUN

6-3 ROCK SOURCE STATE LAND, EXISTING STOCKPILE

Rock used in accordance with the quantities on the ROCK LIST may be obtained from the following existing stockpile(s) on state land at no charge to the Purchaser. Purchaser shall not remove additional yardage without prior written approval from the Contract Administrator. Other stockpiles may not be used without prior written approval from the Contract Administrator.

<u>Source</u>	<u>Location</u>	<u>Rock Type</u>
7500 Stockpile	7500 at 88+00 Right	CRUSHED ROCK

6-5 ROCK FROM COMMERCIAL SOURCE

Rock used in accordance with the quantities on the ROCK LIST may be obtained from any commercial source at the Purchaser's expense. Rock sources are subject to written approval by the Contract Administrator before their use.

<u>Possible Source</u>	<u>Phone</u>
Burns Construction	360-795-3797

6-10 ROCK SOURCE DEVELOPMENT PLAN BY STATE

Purchaser shall conduct rock source development and use at the following sources, in accordance with the written ROCK SOURCE DEVELOPMENT PLAN prepared by the state and included in this road plan. Upon completion of operations, the rock source must be left in the condition specified in the ROCK SOURCE DEVELOPMENT PLAN, and approved in writing by the Contract Administrator. Purchaser shall notify the Contract Administrator a minimum of 5 business days before starting any operations in the rock source.

<u>Source</u>
7500 Pit

6-22 FRACTURE REQUIREMENT FOR ROCK

A minimum of 50% by visual inspection of coarse aggregate must have at least one fractured face. Coarse aggregate is the material greater than 1/4-inch in size.

6-23 ROCK GRADATION TYPES

Purchaser shall provide and/or manufacture rock in accordance with the types and amounts listed in the ROCK LIST. Rock must meet the following specifications for gradation and uniform quality when placed in hauling vehicles. The exact point of evaluation for conformance to specifications will be determined by the Contract Administrator. Purchaser shall provide a sieve analysis upon request from the Contract Administrator.

6-37 4-INCH JAW RUN ROCK

% Passing 4" square sieve	95%
% Passing U.S. #40 sieve	16% maximum
% Passing U.S. #200 sieve	5% maximum

The portion of aggregate retained on the No. 4 sieve may not contain more than 0.2 percent organic debris and trash. All percentages are by weight.

6-55 ROCK APPLICATION MEASURED BY COMPACTED DEPTH

Measurement of specified rock depths are defined as the compacted depth(s) using the compaction methods required in this road plan. Estimated quantities specified in the ROCK LIST are loose yards. Purchaser shall apply adequate amounts of rock to meet the specified rock depths. Specified rock depths are minimum requirements and are not subject to reduction.

6-70 APPROVAL BEFORE ROCK APPLICATION

Purchaser shall obtain written approval from the Contract Administrator for subgrade construction, compaction, and drainage installation before rock application.

6-71 ROCK APPLICATION

Purchaser shall apply rock in accordance with the specifications and quantities shown on the ROCK LIST. Rock must be spread, shaped, and compacted full width concurrent with rock hauling operations. The Contract Administrator will direct locations for rock that is to be applied as spot patching. Road surfaces must be compacted in accordance with the COMPACTION LIST by routing equipment over the entire width.

6-73 ROCK FOR WIDENED PORTIONS

Purchaser shall apply rock to turnarounds, turnouts, and areas with curve widening to the same depth and specifications as the traveled way.

6-76 DRY WEATHER ROCK COMPACTION

The Contract Administrator may require the application of water to facilitate compaction of the rock surfacing. The method of water application is subject to approval by the Contract Administrator.

6-80 WATERING FOR DUST ABATEMENT

Purchaser shall use water for dust abatement as directed by the Contract Administrator.

SECTION 7 – STRUCTURES

7-6 STREAM CROSSING INSTALLATION

Purchaser shall install stream crossing structures in accordance with the LIVE STREAM CULVERT INSTALLATION PROCEDURE, CULVERT AND DRAINAGE SPECIFICATION DETAIL, and any other requirements in this road plan.

SECTION 8 – EROSION CONTROL

8-2 PROTECTION FOR EXPOSED SOIL

Purchaser shall provide and evenly spread a 4-inch layer of straw to all exposed soils within 50 feet of a stream or wetland.

8-15 REVEGETATION

Contractor shall spread grass seed on all exposed soils resulting from road work activities. Required seed not spread by the termination of this contract will become the property of the state.

<u>Road</u>	<u>Qty (lbs)*</u>
E-5035	37
E-5035A	15
E-5036	73
E-5037	218
E-5038	33
E-5039	55
Total	431

*Quantities are estimates only. Actual quantities may vary and are the responsibility of the Purchaser.

8-16 REVEGETATION SUPPLY

The Purchaser shall provide the grass seed.

8-17 REVEGETATION TIMING

Purchaser shall revegetate during the first available opportunity after road work is completed. Soils may not be allowed to sit exposed for longer than one month without receiving revegetation treatment unless otherwise approved in writing by the Contract Administrator.

8-25 GRASS SEED

Purchaser shall evenly spread the seed mixture listed below on all exposed soil at a rate of 50 pounds per acre of exposed soil. Grass seed must meet the following specifications:

1. Weed seed may not exceed 0.5% by weight.
2. All seed species must have a minimum 90% germination rate, unless otherwise specified.
3. Seed must be certified.
4. Seed must be furnished in standard containers showing the following information:
 - a. Common name of seed
 - b. Net weight
 - c. Percent of purity
 - d. Percentage of germination
 - e. Percentage of weed seed and inert material
5. Seed must conform to the following mixture unless a comparable mix is approved in writing by the Contract Administrator.

<u>Kind and Variety of Seed in Mixture</u>	<u>% by Weight</u>
Ryegrass	35-45
Fescue	30-45
Highland Bent	5-15
White Clover	8-20
Inert and Other Crop	0.5

SECTION 9 – POST-HAUL ROAD WORK

9-3 CULVERT MATERIAL REMOVED FROM STATE LAND

Culverts removed from roads become the property of the Purchaser and must be removed from state land.

9-10 LANDING DRAINAGE

Purchaser shall provide for drainage of the landing surface.

SECTION 10 MATERIALS

10-17 CORRUGATED PLASTIC CULVERT

Polyethylene culverts must meet AASHTO M-294 specifications, or ASTM F-2648 specifications for recycled polyethylene. Culverts must be Type S – double walled with a corrugated exterior and smooth interior.

10-22 PLASTIC BAND

Plastic coupling and end bands must meet the AASHTO specification designated for the culvert. Only fittings supplied or recommended by the culvert manufacturer may be used. Couplings must be split coupling band. Split coupling bands must have a minimum of four corrugations, two on each side of the pipe joint.

TYPICAL SECTION SHEET

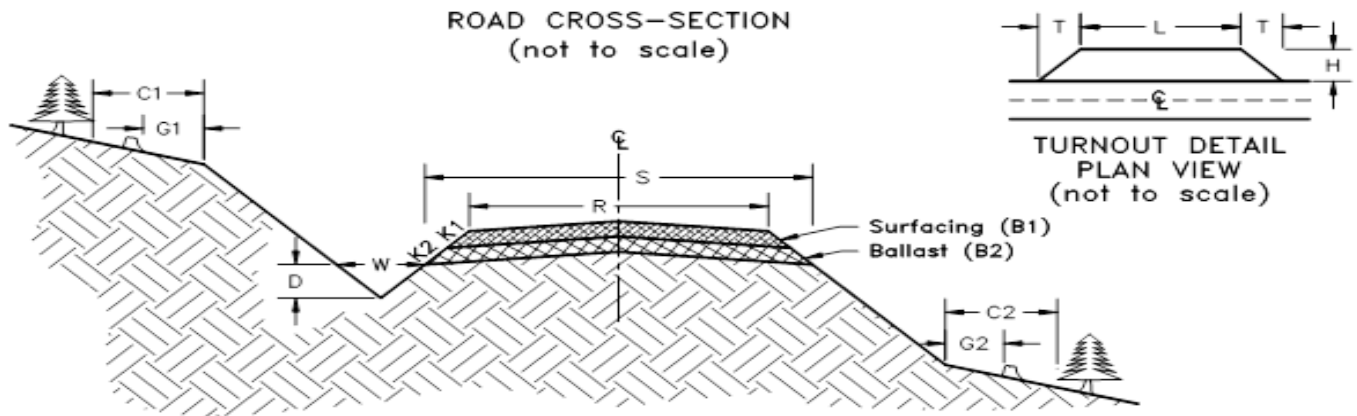

Road Name	From Station	To Station	Tolerance Class	Width (ft)		Ditch (ft)		Crown (%)	Grubbing Limits (ft)		Clearing Limits (ft)	
				Subgrade (S)	Road (R)	Width (W)	Depth (D)		G1	G2	C1	C2
E-5800	0+00	22+44	A	-	12	3	1	4	-	-	-	-
E-5000	11+29	341+87	A	-	12	3	1	4	-	-	-	-
E-7500	0+00	83+45	A	-	12	3	1	4	-	-	-	-
E-7507	0+00	2+48	A	-	12	3	1	4	-	-	-	-
E-5035	0+00	8+13	C	16	12	3	1	4	5	5	10	10
E-5035A	0+00	3+34	C	16	12	3	1	4	5	5	10	10
E-5036	0+00	15+90	C	16	12	3	1	4	5	5	10	10
E-5037	0+00	11+05	C	16	12	3	1	4	5	5	10	10
E-5037	11+05	47+55	C	16	12	3	1	4	5	5	10	10
E-5038	0+00	7+12	C	16	12	3	1	4	5	5	10	10
E-5039	0+00	11+91	C	16	12	3	1	4	5	5	10	10

ROCK LIST
(Page 1 of 2)

ROAD CROSS-SECTION
(not to scale)

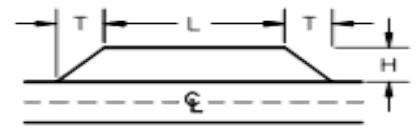
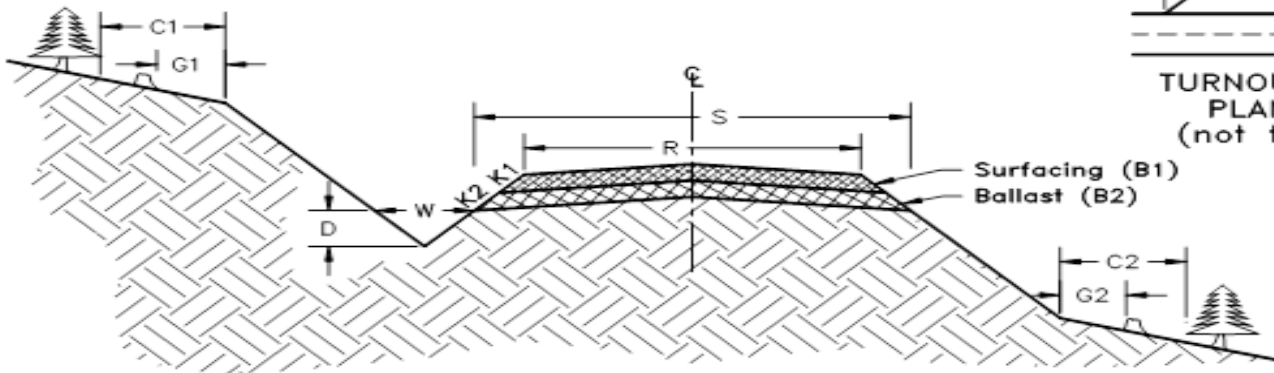

TURNOUT DETAIL
PLAN VIEW
(not to scale)

STOCKPILED CRUSHED ROCK

Road	From	To	Compacted		No. Stations	CY Subtotal	Rock		
			Rock Depth (in)	CY/Station			Source	Turnout (ft)	
							L	H	T
E-5800	0+00	22+44	Spot Rock			60			
E-5000	11+29	341+87	Spot Rock			840			
E-7500	0+00	83+45	Spot Rock			220			
E-7507	0+00	2+48	Spot Rock			40			

REQUIRED STOCKPILED CRUSHED ROCK TOTAL 1160

Cubic Yards

ROCK LIST
(Page 2 of 2)

4-INCH JAW RUN ROCK

Road	From	To	Compacted			Rock			Turnout (ft)		
			Rock Depth (in)	CY/ Station	No. Stations	CY Subtotal	Source	L	H	T	
E-5035	0+00	8+13	18	98	8.13	793	E-7500 Pit				
E-5035	Turnaround	6+30	-	-	-	63					
E-5035	Landing	8+13	-	-	-	95					
E-5035	Culvert	-	-	-	-	2					
E-5035A	0+00	3+34	18	98	3.34	326					
E-5035A	Turnaround	2+00	-	-	-	63					
E-5035A	Landing	3+34	-	-	-	95					
E-5035A	Culvert	-	-	-	-	4					
E-5036	0+00	15+90	18	98	15.90	1,550					
E-5036	Turnaround	6+40	-	-	-	63					
E-5036	Turnaround	14+76	-	-	-	63					
E-5036	Landing	15+90	-	-	-	95					
E-5036	Culvert	-	-	-	-	8					
E-5037	0+00	47+55	18	98	47.55	4,636					
E-5037	Turnout	13+93	-	-	-	52		50	10	25	
E-5037	Turnout	18+91	-	-	-	52		50	10	25	
E-5037	Turnout	28+05	-	-	-	52		50	10	25	
E-5037	Turnaround	45+92	-	-	-	63					
E-5037	Landing	47+55	-	-	-	95					
E-5037	Culvert	-	-	-	-	38					
E-5038	0+00	7+12	18	98	7.12	694					
E-5038	Turnaround	5+60	-	-	-	63					
E-5038	Culvert	-	-	-	-	2					
E-5039	0+00	11+91	18	98	11.91	1,161					
E-5039	Turnaround	6+76	-	-	-	63					
E-5039	Turnaround	10+36	-	-	-	63					
E-5039	Landing	11+91	-	-	-	95					
E-5039	Culvert	-	-	-	-	6					

REQUIRED 4-INCH JAW RUN ROCK TOTAL 10,349

Cubic Yards

CULVERT LIST

Road		Culvert	Length (ft)	Erosion rock			Bedding/backfill		Construction	Culvert marker		Remarks
Name	Station	Diameter (in)	Culvert	Inlet (CY)	Outlet (CY)	Type	(CY)	Type	Staked (Y/N)	Inlet (Y/N)	Outlet (Y/N)	
E-5035	7+53	18	30	1	1	JR	-	NT	N	Y	Y	Cross Drain
E-5035A	0+00	18	30	1	1	JR	-	NT	N	Y	Y	Cross Drain
E-5035A	2+74	18	30	1	1	JR	-	NT	N	Y	Y	Cross Drain
E-5036	0+00	18	30	1	1	JR	-	NT	N	Y	Y	Cross Drain
E-5036	2+75	18	30	1	1	JR	-	NT	N	Y	Y	Cross Drain, Sag
E-5036	7+15	18	30	1	1	JR	-	NT	N	Y	Y	Cross Drain
E-5036	11+66	18	30	1	1	JR	-	NT	N	Y	Y	Cross Drain
E-5037	5+95	18	30	1	1	JR	-	NT	N	Y	Y	Disconnect
E-5037	6+85	24	50	4	4	JR	-	NT	N	Y	Y	Stream Crossing
E-5037	9+39	24	40	4	4	JR	-	NT	N	Y	Y	Stream Crossing
E-5037	15+83	18	30	1	1	JR	-	NT	N	Y	Y	Disconnect
E-5037	16+43	24	40	4	4	JR	-	NT	N	Y	Y	Stream Crossing
E-5037	17+03	18	30	1	1	JR	-	NT	N	Y	Y	Disconnect
E-5037	22+84	18	30	1	1	JR	-	NT	N	Y	Y	Cross Drain
E-5037	31+17	18	30	1	1	JR	-	NT	N	Y	Y	Cross Drain
E-5037	36+09	18	30	1	1	JR	-	NT	N	Y	Y	Cross Drain
E-5037	46+95	18	30	1	1	JR	-	NT	N	Y	Y	Cross Drain
E-5038	3+50	18	30	1	1	JR	-	NT	N	Y	Y	Cross Drain
E-5038	7+12	-	-	-	-	-	-	-	-	-	-	DOL
E-5039	2+66	18	30	1	1	JR	-	NT	N	Y	Y	Cross Drain
E-5039	5+53	-	-	-	-	-	-	-	-	-	-	DOL
E-5039	9+26	18	30	1	1	JR	-	NT	N	Y	Y	Cross Drain
E-5039	11+31	18	30	1	1	JR	-	NT	N	Y	Y	Cross Drain

Key

- JR- 4-INCH JAW RUN ROCK
- NT- NATIVE MATERIAL
- DOL- Ditchout left
- DOR- Ditchout right

COMPACTION LIST

				<u>Maximum</u>				<u>Maximum</u>	<u>Maximum</u>
				<u>Depth</u>		<u>Equipment</u>	<u>Minimum</u>	<u>Operating</u>	<u>Amount of</u>
<u>Road</u>	<u>From</u>	<u>To</u>		<u>Per Lift</u>	<u>Equipment</u>	<u>Weight</u>	<u>Number</u>	<u>Speed</u>	<u>Deflection</u>
<u>Name</u>	<u>Station</u>	<u>Station</u>	<u>Type</u>	<u>(inches)</u>	<u>Type</u>	<u>(pounds)</u>	<u>of Passes</u>	<u>(MPH)</u>	<u>(inches)</u>
All	-	-	Existing Surface	-	Vibratory Smooth Drum	20000	5	3	1
All	-	-	Subgrade	-	Vibratory Smooth Drum	20000	4	3	1
All	-	-	Embankment	12	Excavation	30000	4	3	2
All	-	-	Fill	24	Excavation	30000	4	3	2
All	-	-	Rock	-	Vibratory Smooth Drum	20000	5	3	1
All	-	-	Waste Area	24	Excavation	30000	-	-	4

CULVERT AND DRAINAGE SPECIFICATION DETAIL
PAGE 1 OF 2

INSTALLATION REQUIREMENTS:

1. Proper preparation of foundation and placement of any required bedding material shall precede the installation of all culverts. This includes necessary leveling of the native trench bottom and compaction of required bedding material to form a uniform, dense, unyielding base. The pipe must be uniformly supported along the barrel.
2. Backfill material shall be compacted under the culvert haunches, around the sides, and above the culvert in accordance with the COMPACTION LIST.

ALL DRAWINGS ARE NOT TO SCALE

CROSS SECTION

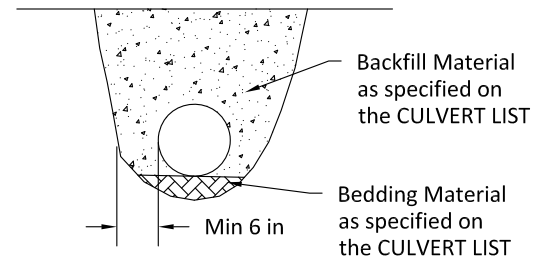

CULVERT PROFILE (TYPICAL)

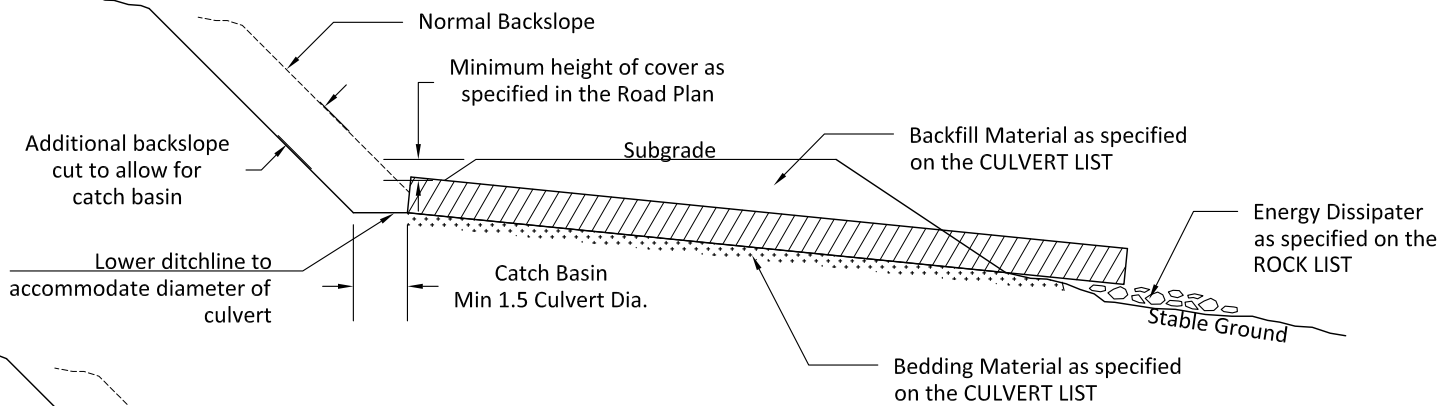

CULVERT WITH DOWNSPOUT OPTION 1

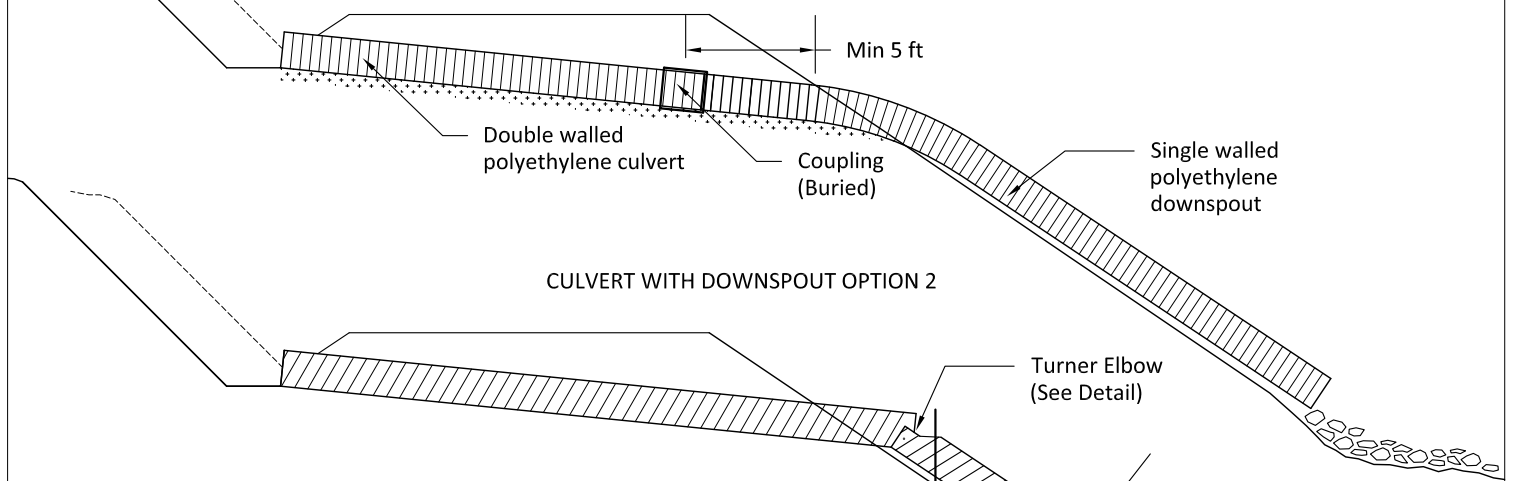

CULVERT WITH DOWNSPOUT OPTION 2

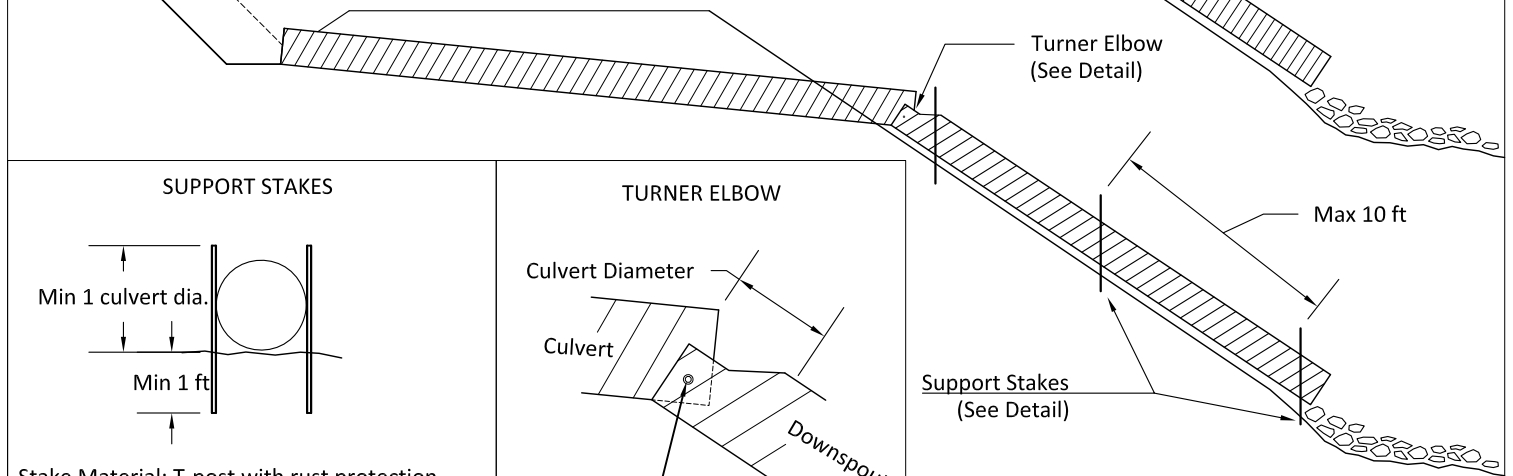

SUPPORT STAKES

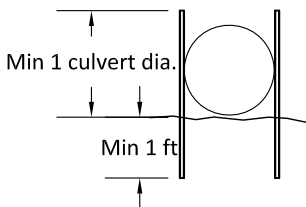

Stake Material: T-post with rust protection coating.
Connections: Bolt support stakes to the culvert with $\frac{5}{8}$ " u-bolts, with washers on both the inside and outside of the culvert.
Alternative staking methods may be approved, in writing, by the Contract Administrator.

TURNER ELBOW

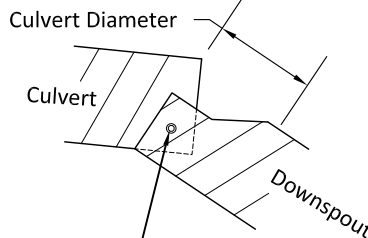

Bolted with $\frac{5}{8}$ " galvanized bolts and washers (both sides)
Downspout must be 6 inches larger in diameter than the culvert.

CULVERT AND DRAINAGE SPECIFICATION DETAIL
PAGE 2 OF 2

HEADWALLS

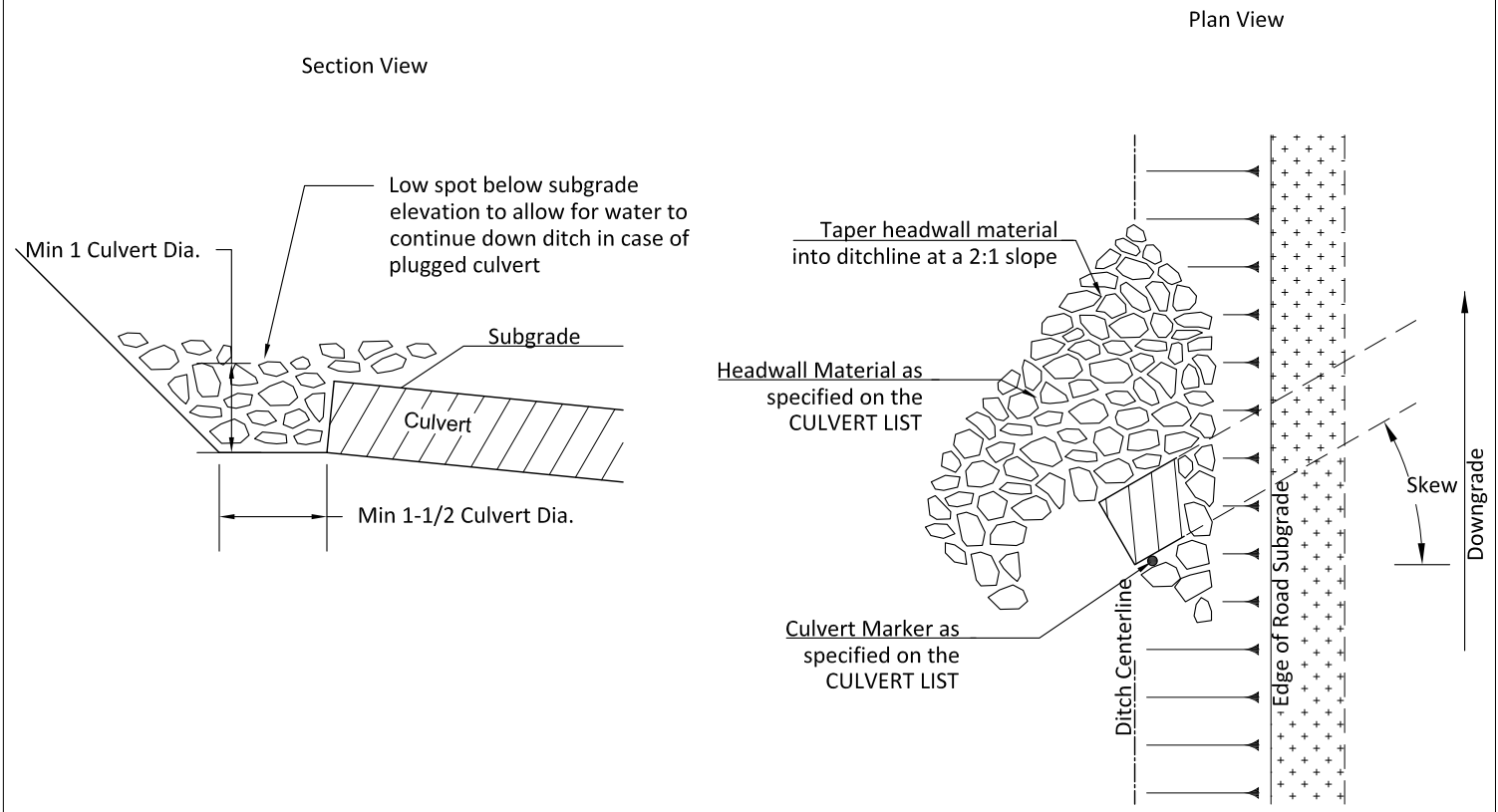

CULVERT MARKERS

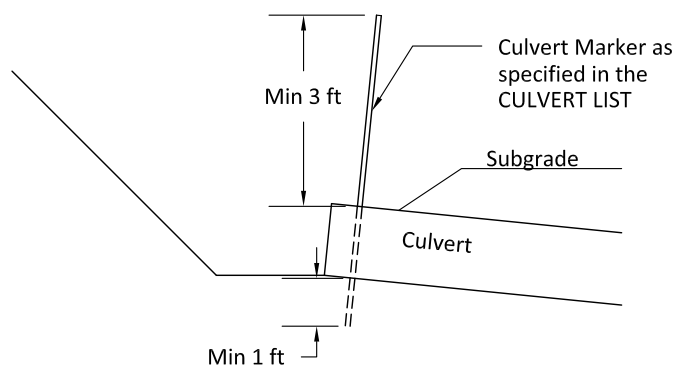

Culvert Marker Material: 1 Inch I.D., Schedule 40 PVC Pipe, White. Marker must be capped on the top.
 Culvert Marker Placement: Place on uphill side of culvert, between corrugations if possible.
 Alternative culvert marker types may be approved, in writing, by the Contract Administrator.

ENERGY DISSIPATORS

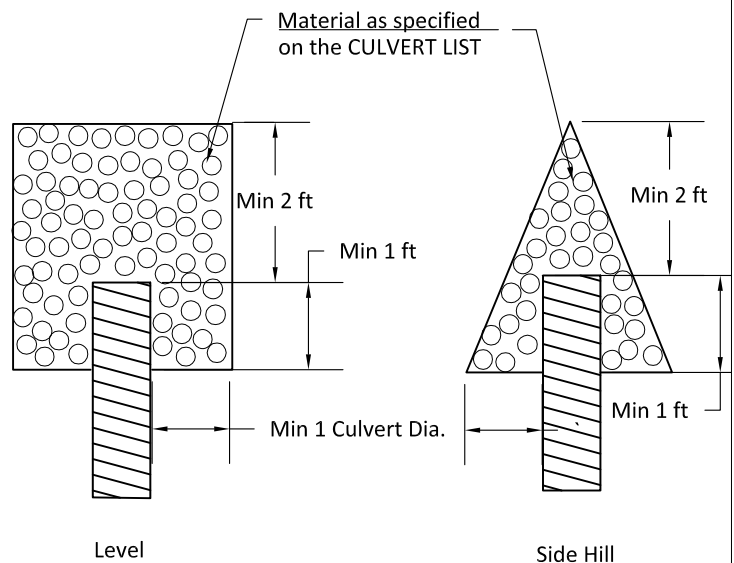

Min Energy Dissipater Depth: 1 Culvert Dia.

FOREST ACCESS ROAD MAINTENANCE SPECIFICATIONS

Page 1 of 2

Cuts and Fills

- Maintain slope lines to a stable gradient compatible with the construction materials. Remove slides from ditches and the roadway. Repair fill-failures with selected material or material approved by the Contract Administrator. Remove overhanging material from the top of cut slopes.
- Waste material from slides or other sources shall be placed and compacted in stable locations identified in the road plan or approved by the Contract Administrator, so that sediment will not deliver to any streams or wetlands.
- Slide material and debris shall not be mixed into the road surface materials, unless approved by the Contract Administrator.

Surface

- Grade and shape the road surface, turnouts, and shoulders to the original shape on the TYPICAL SECTION SHEET to provide a smooth, rut-free traveled surface and maintain surface water runoff in an even, unconcentrated manner.
- Blading shall not undercut the backslope or cut into geotextile fabric on the road.
- If required by the Contract Administrator, water shall be applied as necessary to control dust and retain fine surface rock.
- Surface material shall not be bladed off the roadway. Replace surface material when lost or worn away, or as directed by the Contract Administrator.
- Remove shoulder berms, created by grading, to facilitate drainage, except as marked or directed by the Contract Administrator.
- For roads with geotextile fabric: spread surface aggregate to fill in soft spots and wheel ruts (barrel spread) to prevent damage to the geotextile fabric.

Drainage

- Prevent silt bearing road surface and ditch runoff from delivering sediment to any streams or wetlands.
- Maintain rolling dips and drivable waterbars as needed to keep them functioning as intended.
- Maintain headwalls to the road shoulder level with material that will resist erosion.
- Maintain energy dissipaters at culvert outlets with non-erodible material or rock.
- Keep ditches, culverts, and other drainage structures clear of obstructions and functioning as intended.
- Inspect and clean culverts at least monthly, with additional inspections during storms and periods of high runoff. This shall be done even during periods of inactivity.

FOREST ACCESS ROAD MAINTENANCE SPECIFICATIONS

Page 2 of 2

Preventative Maintenance

- Perform preventative maintenance work to safeguard against storm damage, such as blading to ensure correct runoff, ditch and culvert cleaning, and waterbar maintenance.

Termination of Use or End of Season

- At the conclusion of logging operations, ensure all conditions of these specifications have been met.

Debris

- Remove fallen timber, limbs, and stumps from the slopes, roadway, ditchlines, and culvert inlets.

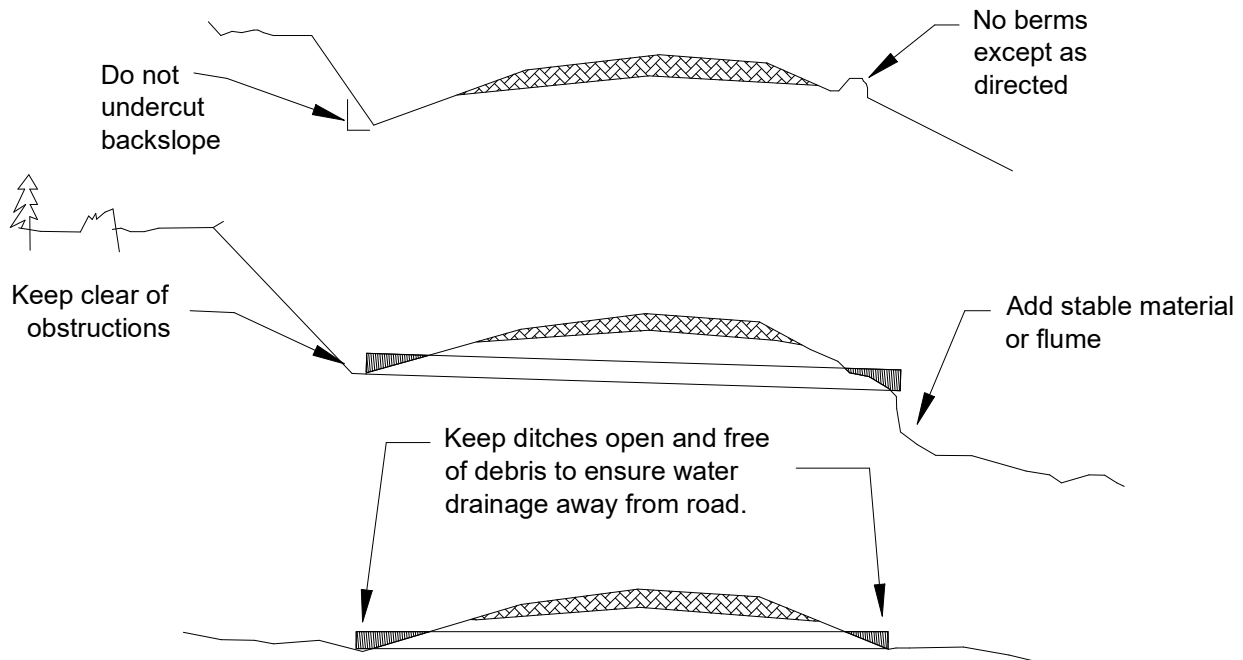

LIVE STREAM CULVERT INSTALLATION PROCEDURE

Order of work is as follows, deviations shall be approved, in writing, by the Contract Administrator.

- 1) Contractor shall notify the Contract Administrator of intent to install each live stream culvert.
- 2) Assemble the items on the Materials List onsite before proceeding.
- 3) Culvert installation may not start during rain or forecast of rain.
- 4) Manage stream water according to the DEWATERING DETAIL.
- 5) Establish culvert lay, install energy dissipater, install culvert, build road fill, and place fill armor.
- 6) Backfill sumps.
- 7) Apply erosion control according to Section 8 of the Road Plan.

Materials List:

- pumps
- erosion rock
- culvert
- fill material
- armor
- grass seed
- straw bales

DEWATERING DETAIL

NOT TO SCALE

Notes:

- Pump clean creek water around the excavation extents and back into the channel below.
- Pump dirty water from site, onto forest floor 100 feet (minimum) from live streams.

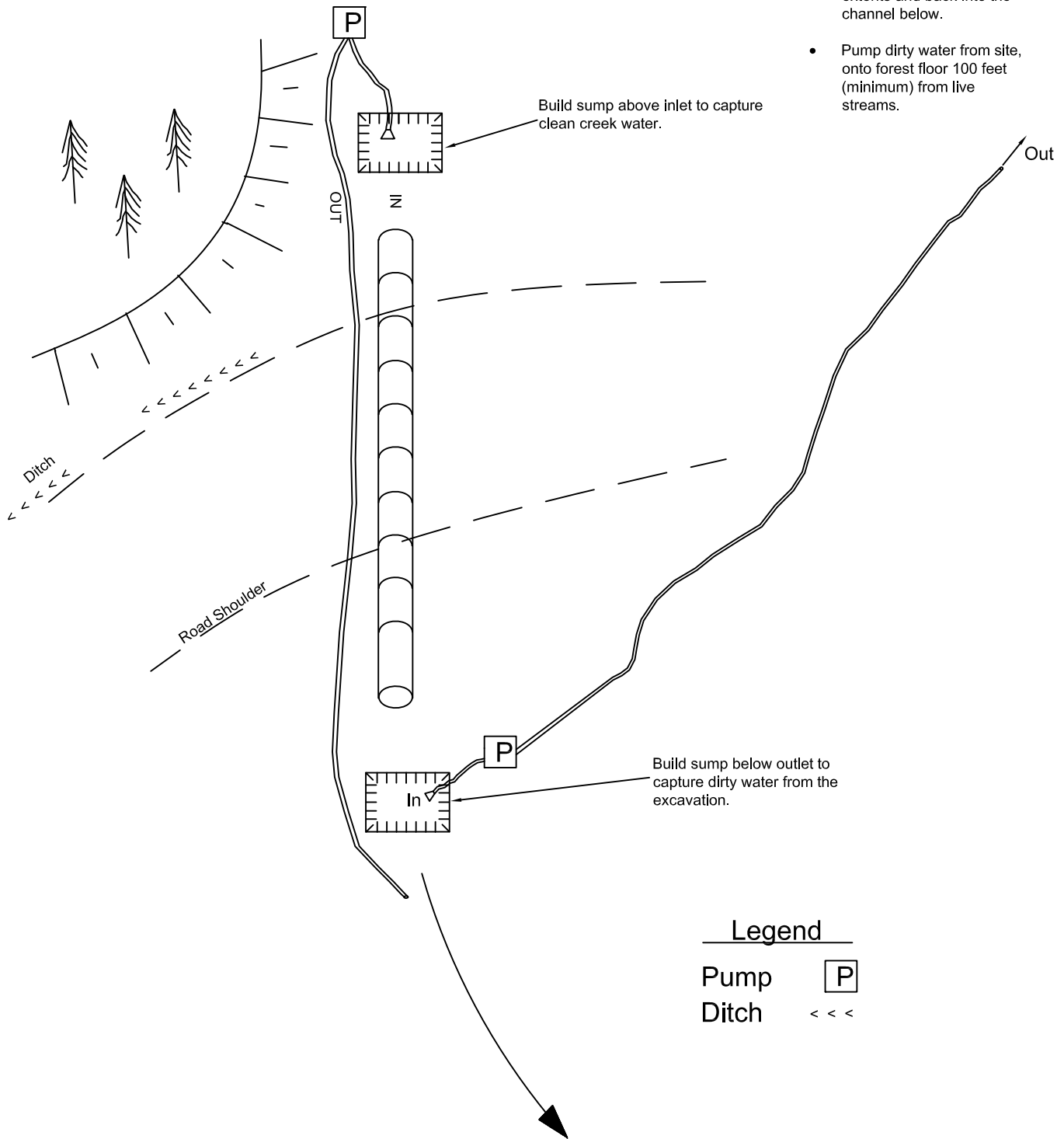

Legend

Pump	P
Ditch	<<<

STATE OF WASHINGTON
DEPARTMENT OF NATURAL RESOURCES

STAIRWAY TO HEMLOCK ROCK SOURCE DEVELOPMENT PLAN
7500 Pit
Page 1 of 3

1. Vegetation shall be cleared a minimum of 10 feet beyond the top of the overburden top of cut.
2. Stumps shall be grubbed a minimum of 5 feet beyond the top of the overburden top of cut.
3. Overburden shall be stripped to rock a minimum of 5 feet beyond the top of all pit faces and sloped no steeper than a 1:1 to daylight.
4. The Operator shall submit an informational drilling and shooting plan to the Contract Administrator prior to any drilling. (Form #M-126PAC)
5. Drilling and rock extraction may begin when the Contract Administrator has approved the clearing and grubbing, overburden removal, and informational drilling and shooting plan.
6. Pit faces shall not exceed 20 feet in height. Faces shall be sloped at $\frac{1}{4}$:1. Working bench width shall be a minimum of 20 feet.
7. The pit floor shall have continuity of slope and be left in a smooth and neat condition, providing drainage at a minimum of 2 percent. All knobs, bumps, or extrusions shall be removed to the designated floor level by excavation or drill and shoot techniques.
8. No sediment shall enter live water.
9. The location and amount of material to be placed in a temporary stockpile are subject to approval of the Contract Administrator. All stockpiled material shall be maintained in a neat and useable condition.
10. Oversize material remaining in the pit at the conclusion of use shall not exceed 5 percent of the total volume mined during that operation. Oversize material is defined as rock fragments larger than two feet in any direction. At the conclusion of operations, all remaining oversize material shall be placed as directed by the Contract Administrator.
11. All operations shall be carried out in compliance with all regulations of:
 - a. Regulations and Standards Applicable to Metal and Nonmetal Mining and Milling Operations (30 CFR) U.S. Department of Labor, Mine Safety and Health Administration.
 - b. "Safety Standards for Construction Work" (296-155 WAC), Washington Department of Labor and Industries.

STATE OF WASHINGTON
DEPARTMENT OF NATURAL RESOURCES

STAIRWAY TO HEMLOCK ROCK SOURCE DEVELOPMENT PLAN
7500 Pit
Page 2 of 3

12. At the end of operations, pit faces and walls shall be scaled and cleared of loose and overhanging material; benches shall have safety berms constructed or access blocked to highway vehicles. Upon completion of operations in the pit, the area will be left in a condition that will not endanger public safety, damage property, or be hazardous to animal or human life.
13. All exposed soil in the waste area shall be revegetated in accordance with ROAD PLAN clause 8-15 through 8-25.
14. The pit area shall be worked and left in a condition that future operations may proceed in an orderly manner.
15. Upon completion of operations, the site shall be cleared of all temporary structures and left in a neat and presentable condition. Access shall be blocked with rip rap as directed by the Contract Administrator.
16. At the completion of rock source operations, the Contractor shall obtain written approval of final rock source condition and compliance with the terms of this plan.

STAIRWAY TO HEMLOCK ROCK SOURCE DEVELOPMENT PLAN

7500 Pit
Page 3 of 3

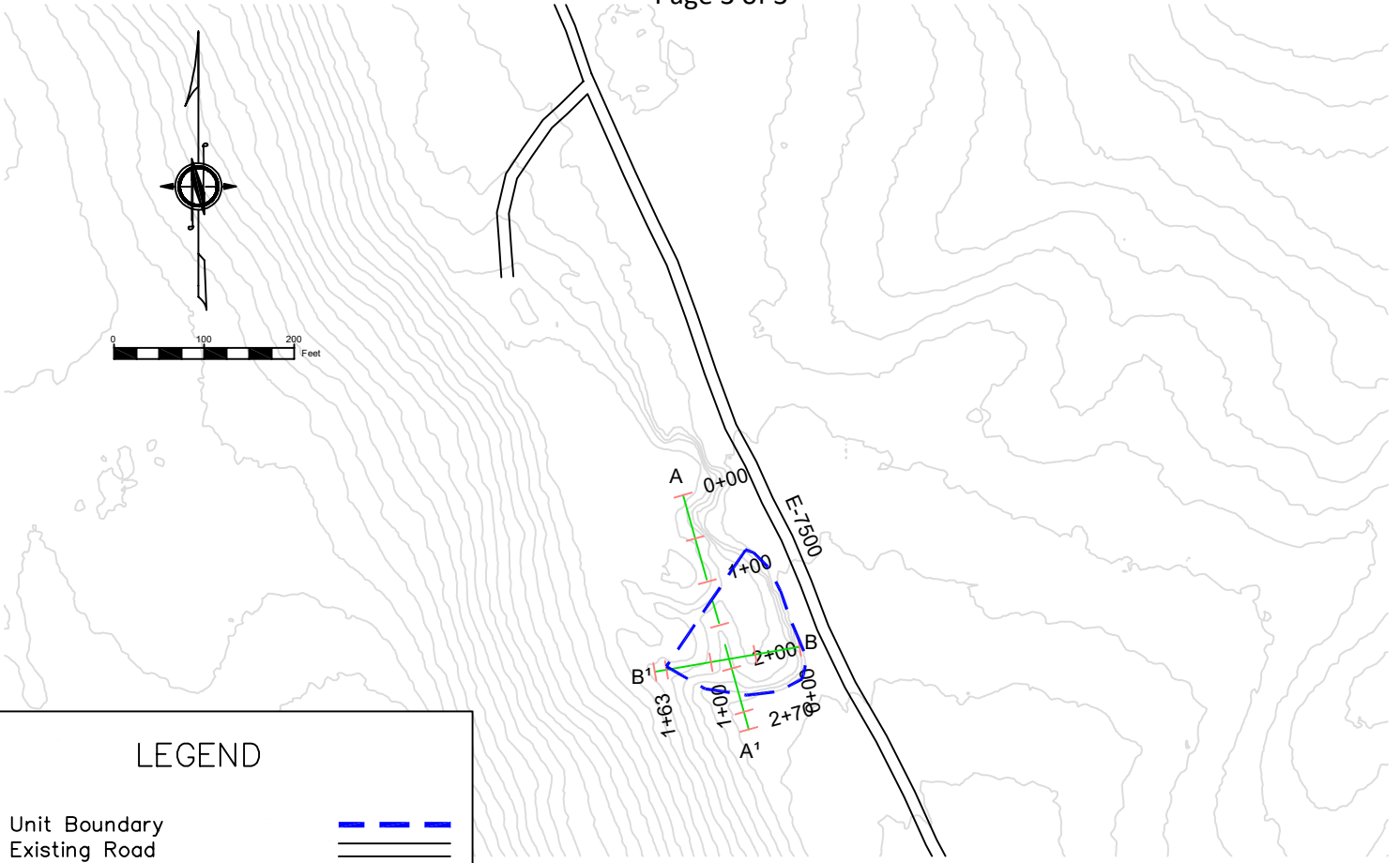

LEGEND

Unit Boundary
Existing Road



CROSS SECTION PROFILE (A-A¹)

Not to Scale

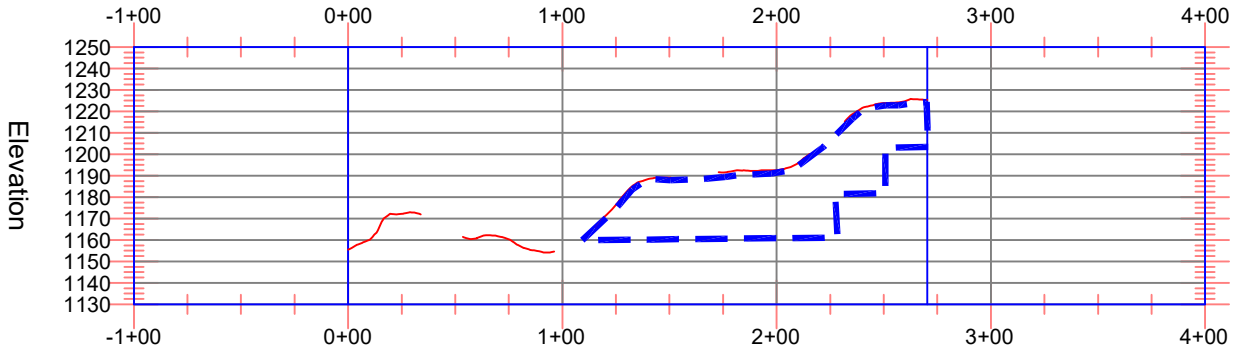

CROSS SECTION PROFILE (B-B¹)

Not to Scale

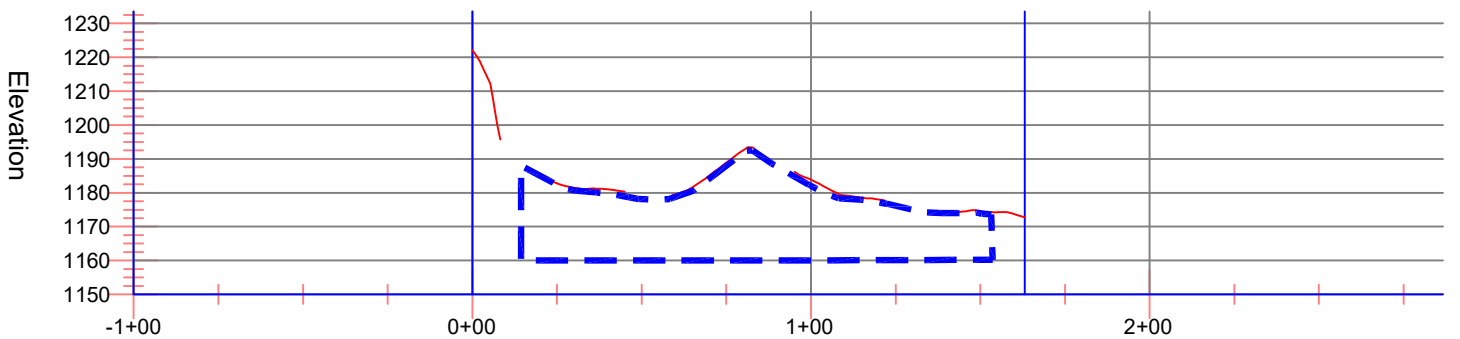

STATE OF WASHINGTON
DEPARTMENT OF NATURAL RESOURCES
PACIFIC CASCADE REGION

INFORMATIONAL BLASTING PLAN

Timber Sale/Project Name: _____ App./Project No.: _____

1. Blaster-in-Charge: Name: _____

Company: _____

Address: _____

Telephone: _____

2. Quarry Name/Location: _____

3. Total Estimated Cubic Yards in Blast (loose): _____

4. Hole Spacing: _____

5. Burden: _____

6. Hole Diameter: _____

7. Hole Depth: _____

8. Sub Drill: _____

9. Number of Holes: _____

10. Stemming Depth: _____

11. Explosive (mfg., name, density, %, V.O.D.): _____

12. Type and Size of Primer (if applicable): _____

13. Total Weight of Primers for Shot: _____

14. Calculated Powder Factor/Cubic Yard: _____

15. Number of Delays (in M.S.): _____

M-126PAC (03/04)

INFORMATIONAL BLASTING PLAN

Page 2 of 3

16. Number of Holes Fired on Each Delay: _____

17. Total Amount of Explosives Fired on Each Delay: _____

18. Type of Blasting Machine: _____

19. Date, Start Drilling: _____

20. Date and Time, Start Loading: _____

21. Date and Time of Blast (approx.): _____

INFORMATIONAL BLASTING PLAN

Page 3 of 3

22. Detail drawing of delay system (show hole pattern and delays in milliseconds). Attach additional sheets if required:

23. Typical cross-section of hole (show primer, main charge, sub drill, and stemming):

23. Submitted by: _____ Date: _____

24. Received by: _____ Date: _____

Note: Attach copies of manufacturer=s data sheet(s) for explosive and caps.

M-126PAC (03/04)

SUMMARY Road Development Estimate
 REGION Pacific Cascade
 DISTRICT St Helens

SALE/PROJECT NAME Stairway to Hemlock

AGREEMENT NO. 30-087001

ROAD NAME E-5035A, E-5035, E-5036, E-5037,
 E-5038, E-5039

E-5000, E-5800, E-7500, E-7507

ROAD STANDARD	Construction	Reconstruction	Maintenance
NUMBER OF STATIONS	93.95	0.00	438.95
CLEARING & GRUBBING	\$ 22,379	\$ -	\$ -
EXCAVATION AND FILL	\$ 69,748	\$ -	\$ -
MISC. MAINTENANCE	\$ 3,056	\$ -	\$ 14,233
ROAD ROCK	Optional	\$ -	\$ -
	Required	\$ 331,938	\$ 33,493
	Total	\$ 341,020	\$ 33,493
ROCK STOCKPILE PROD	\$ -	\$ -	\$ -
CULVERTS AND FLUMES	\$ 16,696	\$ -	\$ -
STRUCTURES	\$ -	\$ -	\$ -
MOBILIZATION	\$ 4,550	\$ -	\$ 4,550
TOTAL COSTS	\$ 457,448	\$ -	\$ 52,276
COST PER STATION	\$ 4,869	\$ -	\$ 119
ROAD DEACTIVATION & ABANDONMENT COSTS	\$ -	\$ -	\$ -

TOTAL (All Roads) \$509,723
TOTAL (Minus Optional Rock) \$509,723
SALE VOLUME MBF 8898
TOTAL \$/MBF \$ 57.29
TOTAL \$/MBF (Minus Optional Rock) \$ 57.29

ESTIMATED BY Chace Johanson

ROCK SOURCE SUMMARY

SALE/PROJECT NAME Stairway to Hemlock
CONTRACT # 30-087001

PIT NAME 7500 Pit
LOCATION S01 T9N R5W

ASSUMED ROCK SWELL FACTOR LOOSE/COMPACTED 1.25
ASSUMED ROCK DENSITY TONS/CY 1.3

MISCELLANEOUS

ROCK PIT PREPARATION

Grubbing w/ large excavator	\$ 280.00	per hour x	10	\$ 2,800
End haul organic debris to Waste Area	\$ 165.00	per hour x	10	\$ 1,650
Stripping overburden w/ large excavator	\$ 280.00	per hour x	10	\$ 2,800
End haul overburden to Waste Area	\$ 165.00	per hour x	10	\$ 1,650

WASTE AREA REVEGETATION

Grass seeding	\$ 3.64	per pound x	50	\$ 182
---------------	---------	-------------	----	--------

MISCELLANEOUS TOTAL \$ 9,082

MOBILIZATION

SALE/PROJECT NAME Stairway to Hemlock
CONTRACT # 30-087001

PRE-HAUL/CONSTRUCTION EQUIPMENT

MOBILIZATION

Grader	0	\$ 1,000	each x	1	\$ 1,000
Loader	0	\$ 1,000	each x	1	\$ 1,000
Dump truck	0	\$ 100	each x	6	\$ 600
Dozer, small	0	\$ 500	each x	1	\$ 500
Dozer, large	0	\$ 1,000	each x	1	\$ 1,000
Excavator, small	0	\$ 500	each x	1	\$ 500
Excavator, large	0	\$ 1,000	each x	1	\$ 1,000
Roller	0	\$ 500	each x	1	\$ 500
Rock drill	0	\$ 1,000	each x	1	\$ 1,000
Jaw	0	\$ 2,000	each x	1	\$ 2,000
PRE-HAUL/CONSTRUCTION SUBTOTAL					\$ 9,100

MOBILIZATION TOTAL \$ 9,100

SUMMARY OF ROAD

SALE/PROJECT NAME Stairway to Hemlock
CONTRACT # 30-087001
ROAD NAME E-5000

Required pre-haul maintenance (stations) 330+58
Distance to E-7500 Stockpile (miles) 1.58

REQUIRED PRE-HAUL MAINTENANCE

MISC. MAINTENANCE

Maintenance grading	\$	18.03	per station x	330.58		\$	5,960
Maintenance rolling	\$	14.39	per station x	330.58		\$	4,758

ROAD ROCK

REQUIRED							
STOCKPILED CRUSHED ROCK	\$	1.64	per CY x	840		\$	1,381
Rock haul	\$	165.00	per hour x	172	round trip haul (miles)	9.42	\$ 28,428

TOTAL ROAD COST \$ 40,528

SUMMARY OF ROAD

SALE/PROJECT NAME Stairway to Hemlock
CONTRACT # 30-087001
ROAD NAME E-5800

Required pre-haul maintenance (stations) 22+44
Distance to E-7500 Stockpile (miles) 2.63

REQUIRED PRE-HAUL MAINTENANCE

MISC. MAINTENANCE

Maintenance grading	\$	18.03	per station x	22.44		\$	405
Maintenance rolling	\$	14.39	per station x	22.44		\$	323

ROAD ROCK

REQUIRED							
STOCKPILED CRUSHED ROCK	\$	1.64	per CY x	60		\$	99
Rock haul	\$	165.00	per hour x	8	round trip haul (miles)	5.68	\$ 1,289

TOTAL ROAD COST \$ 2,115

SUMMARY OF ROAD

SALE/PROJECT NAME Stairway to Hemlock
CONTRACT # 30-087001
ROAD NAME E-7500

Required pre-haul maintenance (stations) 83+45
Distance to E-7500 Stockpile (miles) 0.00

REQUIRED PRE-HAUL MAINTENANCE

MISC. MAINTENANCE

Maintenance grading	\$	18.03	per station x	83.45		\$	1,505
Maintenance rolling	\$	14.39	per station x	83.45		\$	1,201

ROAD ROCK

REQUIRED							
STOCKPILED CRUSHED ROCK	\$	1.64	per CY x	220		\$	362
Rock haul	\$	165.00	per hour x	10.6	round trip haul (miles)	1.58	\$ 1,752

TOTAL ROAD COST \$ 4,820

SUMMARY OF ROAD

SALE/PROJECT NAME Stairway to Hemlock
 CONTRACT # 30-087001
 ROAD NAME E-5035

Optional construction (stations) 8+13
 Distance to E-7500 Pit (miles) 4.58

OPTIONAL CONSTRUCTION

CLEARING & GRUBBING

Clearing & grubbing \$ 238.20 per station x 8.13 \$ 1,937

EXCAVATION AND FILL

Construction \$ 658.00 per station x 8.13 \$ 5,350

Landing \$ 284.00 each x 1 \$ 284

Turnaround \$ 284.00 each x 1 \$ 284

Shape & compact subgrade \$ 36.03 per station x 8.13 \$ 293

MISC. MAINTENANCE

Grass seeding \$ 3.64 per pound x 37 \$ 136

ROAD ROCK

REQUIRED

4-INCH JAW RUN ROCK \$ 12.27 per CY x 952 \$ 11,674

Rock haul \$ 165.00 per hour x 104.5 round trip haul (miles) 9.31 \$ 17,237

Spread & compact rock \$ 3.06 per CY x 950 \$ 2,903

Place erosion rock \$ 10.25 per CY x 2 \$ 21

CULVERTS AND FLUMES

18" Polyethylene, double wall \$ 20.89 per foot x 30 \$ 627

Culvert marker \$ 28.50 each x 2 \$ 57

TOTAL ROAD COST \$ 40,801

SUMMARY OF ROAD

SALE/PROJECT NAME Stairway to Hemlock
 CONTRACT # 30-087001
 ROAD NAME E-5035A

Optional construction (stations) 3+34
 Distance to E-7500 Pit (miles) 4.68

OPTIONAL CONSTRUCTION

CLEARING & GRUBBING

Clearing & grubbing \$ 238.20 per station x 3.34 \$ 796

EXCAVATION AND FILL

Construction \$ 658.00 per station x 3.34 \$ 2,198
 Landing \$ 284.00 each x 1 \$ 284
 Turnaround \$ 284.00 each x 1 \$ 284
 Shape & compact subgrade \$ 36.03 per station x 3.34 \$ 120

MISC. MAINTENANCE

Grass seeding \$ 3.64 per pound x 15 \$ 56

ROAD ROCK

REQUIRED

4-INCH JAW RUN ROCK \$ 12.27 per CY x 483 \$ 5,920
 Rock haul \$ 165.00 per hour x 53.5 round trip haul (miles) 9.42 \$ 8,828
 Spread & compact rock \$ 3.06 per CY x 483 \$ 1,476
 Place erosion rock \$ 10.25 per CY x 4 \$ 41

CULVERTS AND FLUMES

18" Polyethylene, double wall \$ 20.89 per foot x 60 \$ 1,254
 Culvert marker \$ 28.50 each x 4 \$ 114

TOTAL ROAD COST \$ 21,370

SUMMARY OF ROAD

SALE/PROJECT NAME Stairway to Hemlock
 CONTRACT # 30-087001
 ROAD NAME E-5036

Optional construction (stations) 15+90
 Distance to E-7500 Pit (miles) 4.24

OPTIONAL CONSTRUCTION

CLEARING & GRUBBING

Clearing & grubbing \$ 238.20 per station x 15.90 \$ 3,787

EXCAVATION AND FILL

Construction \$ 658.00 per station x 15.90 \$ 10,462

Landing \$ 284.00 each x 1 \$ 284

Turnaround \$ 284.00 each x 2 \$ 568

Shape & compact subgrade \$ 36.03 per station x 15.90 \$ 573

MISC. MAINTENANCE

Grass seeding \$ 3.64 per pound x 73 \$ 266

ROAD ROCK

REQUIRED

4-INCH JAW RUN ROCK \$ 12.27 per CY x 1770 \$ 21,709

Rock haul \$ 165.00 per hour x 185.0 round trip haul (miles) 8.79 \$ 30,523

Spread & compact rock \$ 3.06 per CY x 1770 \$ 5,410

Place erosion rock \$ 10.25 per CY x 8 \$ 82

CULVERTS AND FLUMES

18" Polyethylene, double wall \$ 20.89 per foot x 120 \$ 2,507

Culvert marker \$ 28.50 each x 8 \$ 228

TOTAL ROAD COST \$ 76,399

SUMMARY OF ROAD

SALE/PROJECT NAME Stairway to Hemlock
 CONTRACT # 30-087001
 ROAD NAME E-5037

Required Construction (stations) 11+05
 Optional construction (stations) 36+50
 Distance to E-7500 Pit (miles) 3.73

REQUIRED CONSTRUCTION

CLEARING & GRUBBING

Clearing & grubbing \$ 238.20 per station x 11.05 \$ 2,632

EXCAVATION AND FILL

Construction \$ 658.00 per station x 11.05 \$ 7,271
 Shape & compact subgrade \$ 36.03 per station x 11.05 \$ 398

MISC. MAINTENANCE

Grass seeding \$ 3.64 per pound x 50.7 \$ 185
 Straw mulching \$ 3,301.40 per acre x 0.2 \$ 495

ROAD ROCK

REQUIRED

4-INCH JAW RUN ROCK \$ 12.27 per CY x 1147 \$ 14,071
 Rock haul \$ 165.00 per hour x 113 round trip haul (miles) 8.15 \$ 18,579
 Spread & compact rock \$ 3.06 per CY x 1147 \$ 3,507
 Place erosion rock \$ 10.25 per CY x 18 \$ 185

CULVERTS AND FLUMES

18" Polyethylene, double wall \$ 20.89 per foot x 30 \$ 627
 24" Polyethylene, double wall \$ 28.26 per foot x 90 \$ 2,543
 Live water installation, diversion/pumping \$ 114.00 each x 2 \$ 228
 Culvert marker \$ 28.50 each x 6 \$ 171

REQUIRED CONSTRUCTION SUBTOTAL \$ 50,892

OPTIONAL CONSTRUCTION

CLEARING & GRUBBING

Clearing & grubbing \$ 238.20 per station x 36.50 \$ 8,694

EXCAVATION AND FILL

Construction \$ 658.00 per station x 36.50 \$ 24,017
 Turnout \$ 284.00 each x 3 \$ 852
 Landing \$ 284.00 each x 1 \$ 284
 Turnaround \$ 284.00 each x 1 \$ 284
 Shape & compact subgrade \$ 36.03 per station x 36.50 \$ 1,315

MISC. MAINTENANCE

Grass seeding \$ 3.64 per pound x 168 \$ 610
 Straw mulching \$ 3,301.40 per acre x 0.3 \$ 990

ROAD ROCK

REQUIRED

4-INCH JAW RUN ROCK \$ 12.27 per CY x 3840 \$ 47,107
 Rock haul \$ 165.00 per hour x 377.0 round trip haul (miles) 8.15 \$ 62,201
 Spread & compact rock \$ 3.06 per CY x 3840 \$ 11,740
 Place erosion rock \$ 10.25 per CY x 20 \$ 205

CULVERTS AND FLUMES

18" Polyethylene, double wall \$ 20.89 per foot x 180 \$ 3,761
 24" Polyethylene, double wall \$ 28.26 per foot x 40 \$ 1,130
 Live water installation, diversion/pumping \$ 114.00 each x 1 \$ 114
 Culvert marker \$ 28.50 each x 14 \$ 399

OPTIONAL CONSTRUCTION SUBTOTAL \$ 163,704

TOTAL ROAD COST \$ 214,595

SUMMARY OF ROAD

SALE/PROJECT NAME Stairway to Hemlock
 CONTRACT # 30-087001
 ROAD NAME E-5038

Optional construction (stations) 7+12
 Distance to E-7500 Pit (miles) 4.01

OPTIONAL CONSTRUCTION

CLEARING & GRUBBING

Clearing & grubbing \$ 238.20 per station x 7.12 \$ 1,696

EXCAVATION AND FILL

Construction \$ 658.00 per station x 7.12 \$ 4,685

Turnaround \$ 284.00 each x 1 \$ 284

Shape & compact subgrade \$ 36.03 per station x 7.12 \$ 257

MISC. MAINTENANCE

Grass seeding \$ 3.64 per pound x 33 \$ 119

ROAD ROCK

REQUIRED

4-INCH JAW RUN ROCK \$ 12.27 per CY x 757 \$ 9,282

Rock haul \$ 165.00 per hour x 74.4 round trip haul (miles) 8.16 \$ 12,270

Spread & compact rock \$ 3.06 per CY x 757 \$ 2,313

Place erosion rock \$ 10.25 per CY x 2 \$ 21

CULVERTS AND FLUMES

18" Polyethylene, double wall \$ 20.89 per foot x 30 \$ 627

Ditchout \$ 100.00 each x 1 \$ 100

Culvert marker \$ 28.50 each x 2 \$ 57

TOTAL ROAD COST \$ 31,711

SUMMARY OF ROAD

SALE/PROJECT NAME Stairway to Hemlock
 CONTRACT # 30-087001
 ROAD NAME E-5039

Optional construction (stations) 11+91
 Distance to E-7500 Pit (miles) 4.19

OPTIONAL CONSTRUCTION

CLEARING & GRUBBING

Clearing & grubbing \$ 238.20 per station x 11.91 \$ 2,837

EXCAVATION AND FILL

Construction \$ 658.00 per station x 11.91 \$ 7,837

Landing \$ 284.00 each x 1 \$ 284

Turnaround \$ 284.00 each x 2 \$ 568

Shape & compact subgrade \$ 36.03 per station x 11.91 \$ 429

MISC. MAINTENANCE

Grass seeding \$ 3.64 per pound x 55 \$ 199

ROAD ROCK

REQUIRED

4-INCH JAW RUN ROCK \$ 12.27 per CY x 1381 \$ 16,937

Rock haul \$ 165.00 per hour x 141.9 round trip haul (miles) 8.61 \$ 23,415

Spread & compact rock \$ 3.06 per CY x 1381 \$ 4,221

Place erosion rock \$ 10.25 per CY x 6 \$ 62

CULVERTS AND FLUMES

18" Polyethylene, double wall \$ 20.89 per foot x 90 \$ 1,880

Ditchout \$ 100.00 each x 1 \$ 100

Culvert marker \$ 28.50 each x 6 \$ 171

TOTAL ROAD COST \$ 58,940

SUMMARY OF ROAD

SALE/PROJECT NAME Stairway to Hemlock
CONTRACT # 30-087001
ROAD NAME E-7507

Required pre-haul maintenance (stations) 2+48
Distance to E-7500 Stockpile (miles) 0.00

REQUIRED PRE-HAUL MAINTENANCE

MISC. MAINTENANCE

Maintenance grading	\$	18.03	per station x	2.48	\$	45
Maintenance rolling	\$	14.39	per station x	2.48	\$	36

ROAD ROCK

REQUIRED						
STOCKPILED CRUSHED ROCK	\$	1.64	per CY x	40	\$	66
Rock haul	\$	165.00	per hour x	1 round trip haul (miles)	0.05	\$ 116

TOTAL ROAD COST \$ 262



WASHINGTON STATE DEPARTMENT OF NATURAL RESOURCES

FOREST EXCISE TAX ROAD SUMMARY SHEET

Region:

Timber Sale Name:

Application Number:

EXCISE TAX APPLICABLE ACTIVITIES

Construction: **linear feet**
Road to be constructed (optional and required) but not abandoned

Reconstruction: **linear feet**
Road to be reconstructed (optional and required) but not abandoned

Abandonment: **linear feet**
Abandonment of existing roads not reconstructed under the contract

Decommission: **linear feet**
Road to be made undriveable but not officially abandoned.

Pre-Haul Maintenance: **linear feet**
Existing road to receive maintenance work (optional and required) prior to haul

EXCISE TAX EXEMPT ACTIVITIES

Temporary Construction: **linear feet**
Roads to be constructed (optional and required) and then abandoned

Temporary Reconstruction: **linear feet**
Roads to be reconstructed (optional and required) and then abandoned

All parties must make their own assessment of the taxable or non-taxable status of any work performed under the timber sale contract. The Department of Revenue bears responsibility for determining forest road excise taxes. The Department of Natural Resources developed this form to help estimate the impact of forest excise taxes. However, the information provided may not precisely calculate the actual amount of taxes due. The Department of Revenue is available for consultation by calling 1.800.548.8829.
(Revised 9/18)

LOGGING PLAN MAP

SALE NAME: STAIRWAY TO HEMLOCK
AGREEMENT#: 30-087001
TOWNSHIP(S): T9R5W
TRUST(S): Capitol Grant (7), Scientific School (10)

REGION: Pacific Cascade Region
COUNTY(S): Wahkiakum
ELEVATION RGE: 811-1258

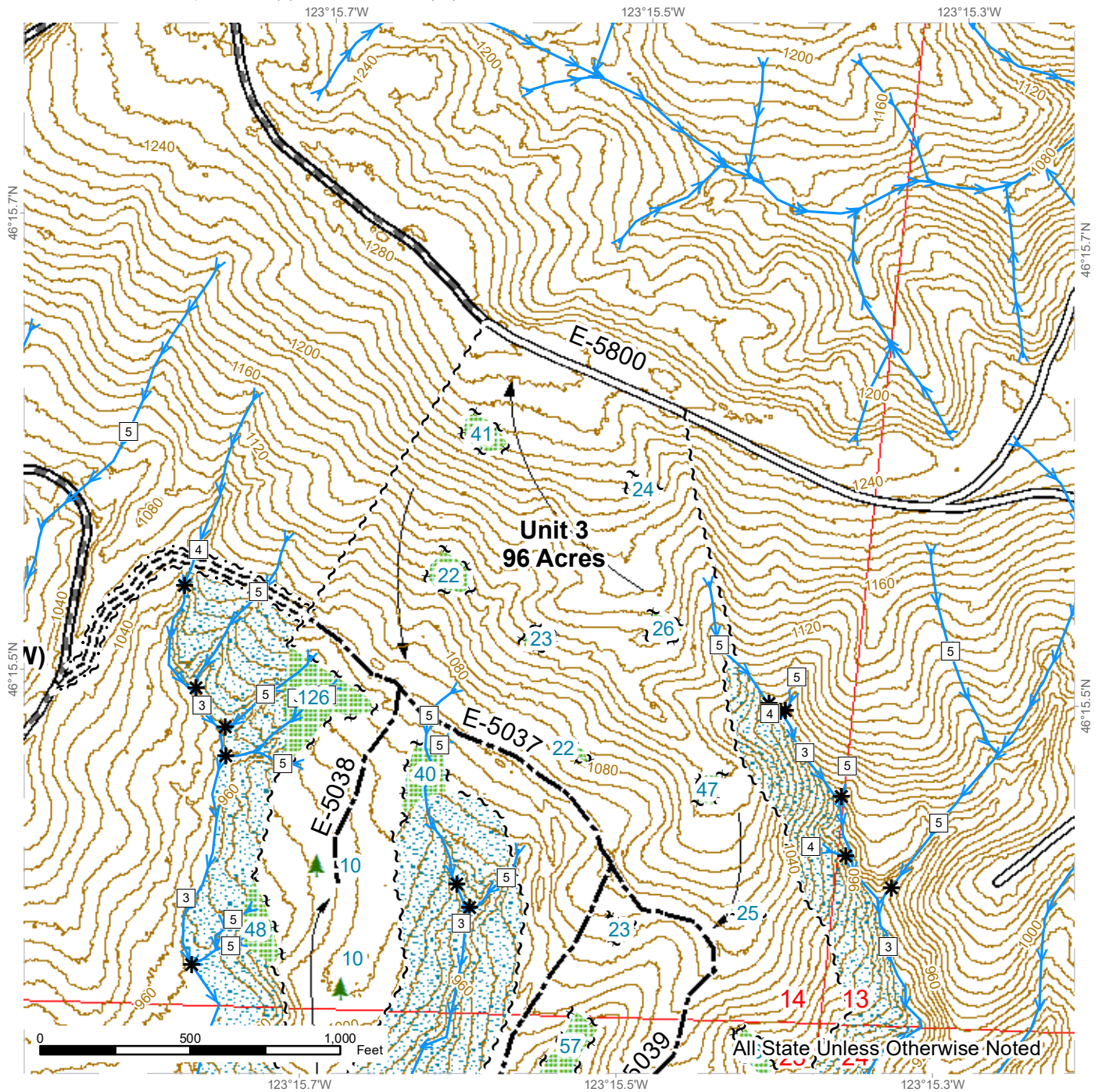

Leave Tree Area	Sale Boundary Tags	Ground Harvest
Riparian Mgt Zone	Leave Tree Tags	Stream Type
Existing Roads	Right of Way Tags	Stream Type Break
Required Pre-Haul Maintenance	Streams	Leave Tree Area <1/4-acre
Required Construction	Contours 10 ft	
Optional Construction	Cable Harvest	



LOGGING PLAN MAP

SALE NAME: STAIRWAY TO HEMLOCK
AGREEMENT#: 30-087001
TOWNSHIP(S): T9R5W
TRUST(S): Capitol Grant (7), Scientific School (10)

REGION: Pacific Cascade Region
COUNTY(S): Wahkiakum
ELEVATION RGE: 811-1258

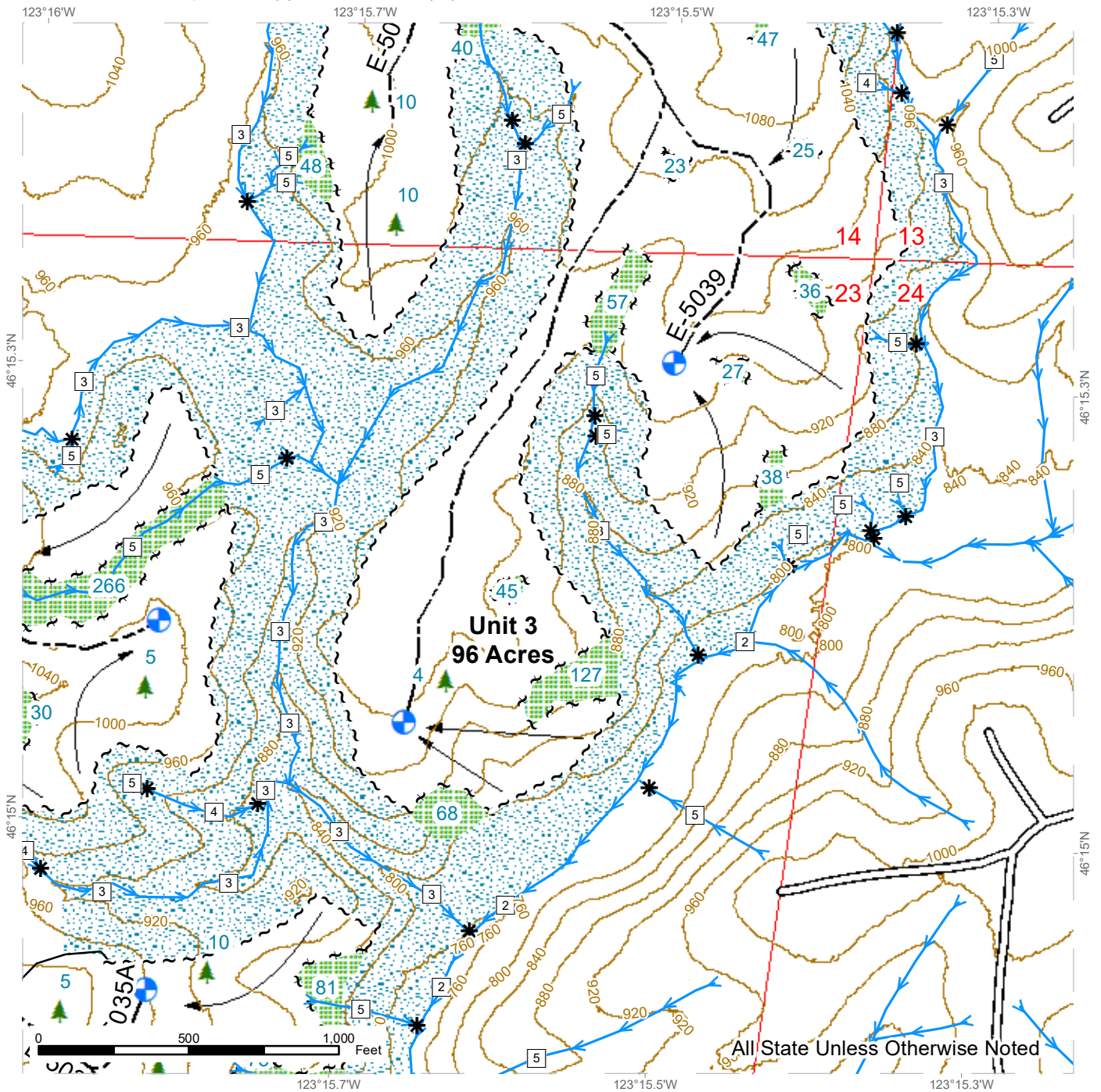

Leave Tree Area	Leave Tree Tags	Stream Type Break
Riparian Mgt Zone	Streams	Landing - Proposed
Existing Roads	Contours 10 ft	Leave Tree Area <1/4-acre
Optional Construction	Cable Harvest	
Sale Boundary Tags	Ground Harvest	
Timber Type Change	Stream Type	