



TIMBER NOTICE OF SALE

SALE NAME: LIBERTY

AGREEMENT NO: 30-106233

AUCTION: June 13, 2024 starting at 10:00 a.m., Southeast Region Office, Ellensburg, WA

COUNTY: Klickitat

SALE LOCATION: Sale located approximately 5 miles north of Appleton, WA

PRODUCTS SOLD AND SALE AREA:

All timber not marked in blue leave tree paint or bound by leave tree tags in Unit 1; delineated by timber sale boundary tags and pink flagging.

All forest products above located on part(s) of Sections 3 all in Township 4 North, Range 12 East, W.M., containing 60 acres, more or less.

CERTIFICATION: This sale is certified under the Sustainable Forestry Initiative® program Standard (cert no: BVC-SFIFM-018227)

ESTIMATED SALE VOLUMES AND QUALITY:

Table with columns: Species, Avg DBH, Ring Count, Total MBF, and MBF by Grade (1P, 2P, 3P, SM, 1S, 2S, 3S, 4S, UT). Rows include Douglas fir and Grand fir.

Table with columns: Species, Avg DBH, Ring Count, Total MBF, and MBF by Grade (P, SM, 1S, 2S, 3S, 4S, 5S, 6S, UT). Rows include Ponderosa pine and Sale Total.

MINIMUM BID: \$226,000.00 BID METHOD: Sealed Bids

PERFORMANCE SECURITY: \$45,200.00 SALE TYPE: Lump Sum

EXPIRATION DATE: October 31, 2026 ALLOCATION: Export Restricted

BID DEPOSIT: \$22,600.00 or Bid Bond. Said deposit shall constitute an opening bid at the appraised price.

HARVEST METHOD: Ground-based equipment. Falling and Yarding will not be permitted from November 1st to April 30th unless authorized in writing by the Contract Administrator.

ROADS: 40.15 stations of required reconstruction. 72.90 stations of required prehaul maintenance. The hauling of forest products will not be permitted from November 1 to April 30 unless authorized in writing by the Contract Administrator.

ACREAGE DETERMINATION

CRUISE METHOD: The sale acres were determined using a Garmin 64 delineation. Cruise was completed using variable plot cruise methods.



TIMBER NOTICE OF SALE

FEES: \$17,272.00 is due on day of sale. \$9.00 per MBF is due upon removal. These are in addition to the bid price.

SPECIAL REMARKS: If a Gray Wolf den site is discovered or suspected within 1 mile of the timber sale, a no-harvest temporary seasonal timing restriction will be enforced immediately for the duration of March 15 through July 30.

TIMBER SALE MAP

SALE NAME: LIBERTY
AGREEMENT #: 30-106233
TOWNSHIP(S): T4R12E
TRUST(S): State Forest Transfer (1)

REGION: Southeast Region
COUNTY(S): Klickitat
ELEVATION RGE: 2280-2400

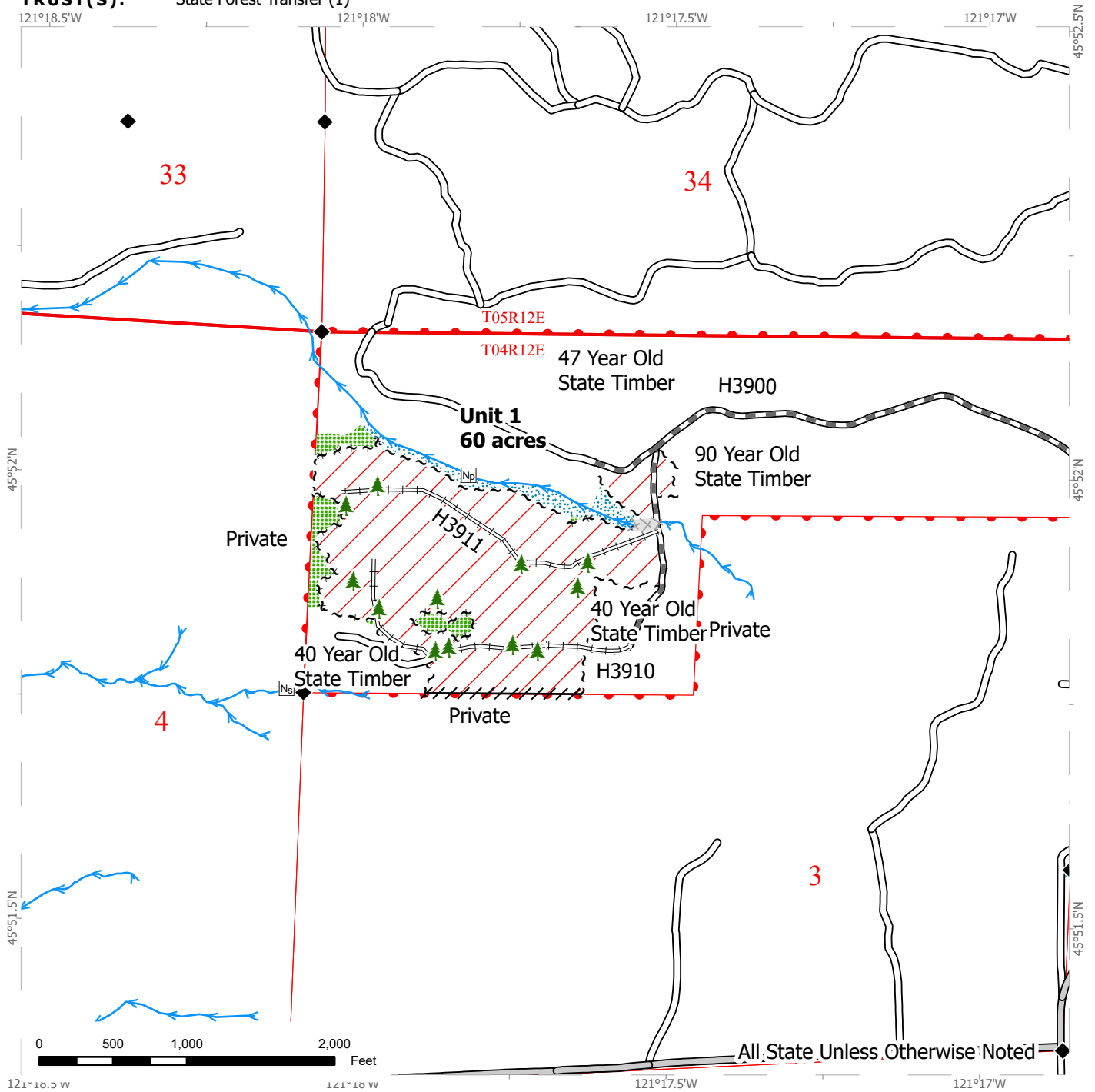

Variable Retention Harvest	County Road	Streams
Leave Tree Area	Required Pre-Haul Maintenance	Non-Fish Perennial
Riparian Mgt Zone	Required Reconstruction	Non-Fish Seasonal
Sale Boundary Tags	Existing Roads	Leave Tree Area < 1/4-acre
Leave Tree Tags	DNR Managed Lands	Survey Monument
Right of Way Tags		
Flag Line		
Equipment Limitation Zone		

DRIVING MAP

SALE NAME: LIBERTY
AGREEMENT#: 30-106233
TOWNSHIP(S): T4R12E
TRUST(S): State Forest Transfer (1)

REGION: Southeast Region
COUNTY(S): Klickitat
ELEVATION RGE: 2280-2400

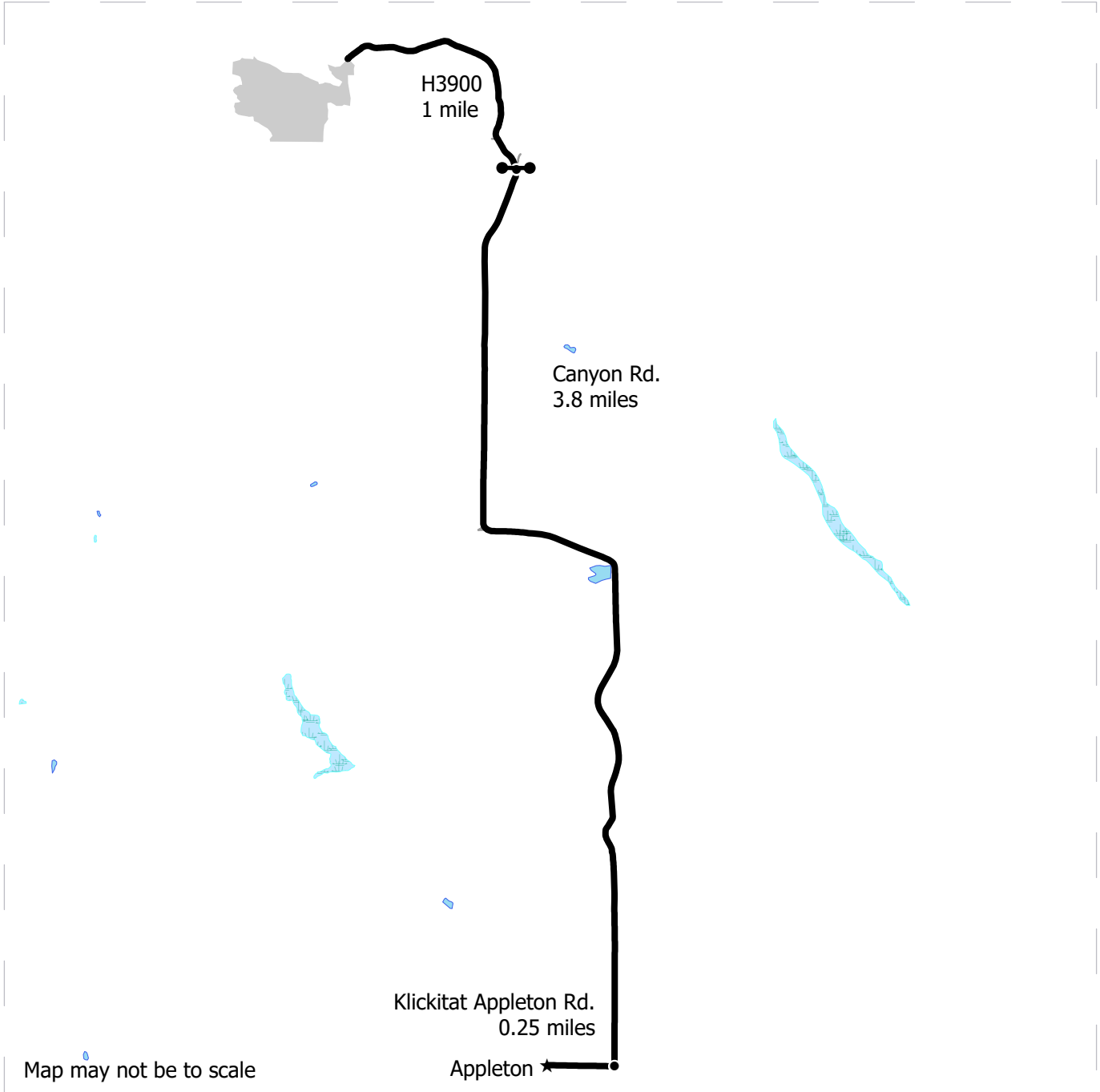

- Harvest Unit
- Haul Route
- Other Route
- Distance Indicator
- Gate
- Town

DRIVING DIRECTIONS:

From Appleton:
Continue east on Klickitat Appleton road for 0.25 miles.
Turn left onto Canyon road and continue for 3.8 miles.
Turn left onto the H3900 and continue for 1 mile. Close Cattle gate before continuing.



**STATE OF WASHINGTON
DEPARTMENT OF NATURAL RESOURCES**

**BILL OF SALE AND CONTRACT FOR
FOREST PRODUCTS**

Export Restricted Lump Sum AGREEMENT NO. 30-0106233

SALE NAME: LIBERTY

**THE STATE OF WASHINGTON DEPARTMENT OF NATURAL
RESOURCES, HEREINAFTER ACTING SOLELY, IN ITS PROPRIETARY
CAPACITY, STATE, AND PURCHASER, AGREE AS FOLLOWS:**

Section G: General Terms

G-001 Definitions

The following definitions apply throughout this contract;

Bill of Sale and Contract for Forest Products: Contract between the Purchaser and the State, which sets forth the procedures and obligations of the Purchaser in exchange for the right to remove forest products from the sale area. The Bill of Sale and Contract for Forest Products may include a Road Plan for any road construction or reconstruction, where applicable.

Contract Administrator: Region Manager's designee responsible for assuring that the contractual obligations of the Purchaser are met.

Forest Product: Any material derived from the forest for commercial use.

Purchaser: The company or individual that has entered into a Bill of Sale and Contract for Forest Products with the State for the right to harvest and remove forest products from the timber sale area.

Road Construction: Includes building new and maintaining existing forest roads and associated work that may be optional or required as described in the Road Plan.

State: The Washington State Department of Natural Resources, landowner and seller of Forest Products from the timber sale area. The State is represented by the Region Manager as designated on the contract signature page. Contractual obligations to the State are enforced by the Region Manager or the designated Contract Administrator.

Subcontractor: Individual or company employed by the Purchaser to perform a portion or all of the services required by The Bill of Sale and Contract for Forest Products. The Purchaser is responsible for independently negotiating, procuring and paying for all subcontracted services rendered.

G-011 Right to Remove Forest Products and Contract Area

Purchaser was the successful bidder on June 13, 2024 and the sale was confirmed on _____. The State, as owner, agrees to sell to Purchaser, and Purchaser agrees to purchase as much of the following forest products as can be cut and removed during the term of this contract: All timber not marked in blue leave tree paint or bound by leave tree tags in Unit 1; delineated by timber sale boundary tags and pink flagging.

All forest products described above located on approximately 60 acres on part(s) of Section 3 in Township 4 North, Range 12 East W.M. in Klickitat County(s) as designated on the sale area and as shown on the attached timber sale map.

All forest products described above from the bole of the tree that meet or exceed 2 inches diameter inside bark on the small end are eligible for removal. Above ground components of a tree that remain as by-products after the manufacture of logs, including but not limited to tree tops, branches, limbs, needles, leaves, stumps, are not eligible for removal under the terms of this contract.

Forest products purchased under a contract that is designated as export restricted shall not be exported until processed. Forest products purchased under a contract that is designated as exportable may be exported prior to processing.

G-020 Inspection By Purchaser

Purchaser hereby warrants to the State that they have had an opportunity to fully inspect the sale area and the forest products being sold. Purchaser further warrants to the State that they enter this contract based solely upon their own judgment of the value of the forest products, formed after their own examination and inspection of both the timber sale area and the forest products being sold. Purchaser also warrants to the State that they enter this contract without any reliance upon the volume estimates, acreage estimates, appraisals, pre-bid documentation, or any other representations by the State Department of Natural Resources.

G-031 Contract Term

Purchaser shall complete all work required by this contract prior to October 31, 2026.

G-040 Contract Term Adjustment - No Payment

Purchaser may request an adjustment in the contract term. A claim must be submitted in writing and received by the State within 30 days after the start of interruption or delay. The claim must also indicate the actual or anticipated length of interruption or delay. The State may grant an adjustment without charge only if the cause for contract term adjustment is beyond Purchaser's control. The cause must be one of the following and the adjustment may be granted only if operations or planned operations under this contract are actually interrupted or delayed:

- a. Road and bridge failures which deny access.
- b. Access road closures imposed by road owner.
- c. Excessive suspensions as provided in clause G-220.
- d. Regulatory actions not arising from Purchaser's failure to comply with this contract which will prevent timber harvest for a period less than 6 months.

G-051 Contract Term Extension - Payment

Extensions of this contract term may be granted only if, in the judgment of the State, Purchaser is acting in good faith and is endeavoring to remove the forest products conveyed. The term of this contract may be extended for a reasonable time by the State if all of the following conditions are satisfied:

- a. A written request for extension of the contract term must be received prior to the expiration date of the contract.
- b. Completion of all required roads and compliance with all contract and regulatory requirements.
- c. For the first extension, not to exceed 1 year, payment of at least 25 percent of the total contract price.

For the second extension, not to exceed 1 year, payment of at least 90 percent of the total contract price.

The payments shall not include the initial deposit which shall be held according to the provisions of RCW 79.15.100.

- d. Payment of an amount based on 12 percent interest per annum on the unpaid portion of the total contract price.

All payments, except the initial deposit, will be deducted from the total contract price to determine the unpaid portion of the contract.

- e. Payment of \$286.00 per acre per annum for the acres on which an operating release has not been issued .
- f. In no event will the extension charge be less than \$200.00.
- g. Extension payments are non-refundable.

G-053 Surveys - Sensitive, Threatened, Endangered Species

Whenever the State determines that a survey for sensitive, threatened, or endangered species is prudent, or when Purchaser determines a survey is prudent and the State agrees, Purchaser shall perform such surveys at Purchaser's expense and to the standards required by the State. The survey information shall be supplied to the State.

G-060 Exclusion of Warranties

The PARTIES AGREE that the IMPLIED WARRANTIES OF MERCHANTABILITY AND FITNESS FOR A PARTICULAR PURPOSE and ALL OTHER WARRANTIES EXPRESSED OR IMPLIED ARE EXCLUDED from this transaction and shall not apply to the goods sold. For example, THE FOLLOWING SPECIFIC MATTERS ARE NOT WARRANTED, and are EXCLUDED from this transaction:

- a. The MERCHANTABILITY of the forest products. The use of the term "merchantable" in any document is not intended to vary the foregoing.
- b. The CONDITION of the forest products. The forest products will be conveyed "AS IS."
- c. The ACREAGE contained within any sale area. Any acreage descriptions appearing in the timber notice of sale, timber sale contract, or other documents are estimates only, provided solely for administrative and identification purposes.
- d. The VOLUME, QUALITY, OR GRADE of the forest products. The State neither warrants nor limits the amount of timber to be harvested. The descriptions of the forest products to be conveyed are estimates only, made solely for administrative and identification purposes.
- e. The CORRECTNESS OF ANY SOIL OR SURFACE CONDITIONS, PRE-SALE CONSTRUCTION APPRAISALS, INVESTIGATIONS, AND ALL OTHER PRE-BID DOCUMENTS PREPARED BY OR FOR THE STATE. These documents have been prepared for the State's appraisal purposes only.
- f. THAT THE SALE AREA IS FREE FROM THREATENED OR ENDANGERED SPECIES or their habitat. The State is not responsible for any interference with forestry operations that result from the presence of any threatened or endangered species, or the presence of their habitat, within the sale area.

- g. THAT THE FORESTRY OPERATIONS to be performed under this contract WILL BE FREE FROM REGULATORY ACTIONS by governmental agencies. The State is not responsible for actions to enforce regulatory laws, such as the Washington Forest Practices Act (chapter 76.09 RCW), taken by the Department of Natural Resources or any other agency that may affect the operability of this timber sale.
- h. Items contained in any other documents prepared for or by the State.

G-061 Inadvertent Discovery of Cultural Resources

Purchaser acknowledges that cultural resources as defined in WAC 222-16-010 may exist within the timber sale area and that the existence and location of such resources may be unknown at the time this contract is executed. Purchaser has a duty to exercise due care in its operations and in the event any human skeletal remains are discovered by the Purchaser or the State during the course of operations Purchaser shall immediately halt operations and notify local law enforcement in the most expeditious manner possible then notifying the Contract Administrator. In the event cultural resources are discovered by the Purchaser or the State during the course of operations Purchaser shall immediately halt operations and notify the Contract Administrator. Any potential resources shall not be removed or disturbed. Purchaser shall resume operations as directed in writing by the Contract Administrator.

G-062 Habitat Conservation Plan

The State has entered into a Habitat Conservation Plan (HCP) with the U.S. Fish and Wildlife Service and the National Marine Fisheries Service (the Services) to address state trust land management issues relating to compliance with the Federal Endangered Species Act. The activities to be carried out under this contract are located within the State's HCP area and are subject to the terms and conditions of the HCP, and the Services' Incidental Take Permit Nos. TE812521-1 and 1168 (collectively referred to as ITP), or as amended hereafter by the Services. The ITP authorizes the incidental take of certain federally listed threatened and endangered species, as specified in the ITP conditions. All HCP materials, including the ITP, are available for review at the State's Regional Offices and the administrative headquarters in Olympia, Washington.

By signing this contract, Purchaser agrees to comply with the terms and conditions of the ITP, and the HCP, which shall become terms of this contract. The State agrees to authorize the lawful activities of the Purchaser carried out pursuant to this contract, PROVIDED the Purchaser remains in compliance with the terms and conditions of both the HCP and ITP. The requirements set forth in this contract are intended to comply with the terms and conditions of the HCP and ITP. Accordingly, non-compliance with the terms and conditions of the HCP and ITP will render the authorization provided in this paragraph void, be deemed a breach of the contract and may subject Purchaser to liability for violation of the Endangered Species Act.

Any modifications to the contract shall be proposed in writing by Purchaser, shall continue to meet the terms and conditions of the HCP and ITP, and shall require the prior written approval of the Region Manager before taking effect.

G-063 Incidental Take Permit Notification Requirements

- a. Purchaser shall immediately notify the Contract Administrator of new locations of permit species covered by the Incidental Take Permits (ITP) that are discovered within the area covered by the State's Habitat Conservation Plan (HCP), including, but not limited to: locations of occupied murrelet habitat; spotted owl nest sites; wolves; grizzly bears; nests, communal roosts, or feeding concentrations of bald eagles; peregrine falcon nests; Columbian white-tailed deer; Aleutian Canada geese; Oregon silverspot butterflies; and additional stream reaches found to contain bull trout. Purchaser is required to notify the Contract Administrator upon discovery of any fish species found in streams or bodies of water classified as non-fish bearing. In all circumstances, notification must occur within a 24 hour time period.
- b. Upon locating any live, dead, injured, or sick specimens of any permit species covered by the ITP, Purchaser shall immediately notify the Contract Administrator. Purchaser shall notify the Contract Administrator if there is any doubt as to the identification of a discovered permit species. Purchaser may be required to take certain actions to help the Contract Administrator safeguard the well-being of any live, injured or sick specimens of any permit species discovered, until the proper disposition of such specimens can be determined by the Contract Administrator. Any such requirements will be explained to Purchaser by the Contract Administrator during the Pre-Work Conference. In all circumstances, notification must occur within a 24 hour time period.
- c. Purchaser shall refer to a specific ITP number, ITP TE812521-1 or ITP 1168 (copies which are located in the region office) in all correspondence and reports concerning permit activities.
- d. Provisions and requirements of the ITP shall be clearly presented and explained to Purchaser by Contract Administrator during the Pre-Work Conference as per contract clause G-330. All applicable provisions of the ITP and this schedule must be presented and clearly explained by Purchaser to all authorized officers, employees, contractors, or agents of Purchaser conducting authorized activities in the timber sale area. Any questions Purchaser may have about the ITP should be directed to the Contract Administrator.

G-064 Permits

Purchaser is responsible for obtaining any permits not already obtained by the State that relate to Purchaser's operation. Forest Practice Application / Hydraulic Project Approval permits obtained by the State shall be transferred to Purchaser. Purchaser is responsible for all permits, amendments and renewals.

G-065 Regulatory Disclaimer

The State disclaims any responsibility for, or liability relating to, regulatory actions by any government agency, including actions pursuant to the Forest Practices Act, Ch. 76.09 RCW that may affect the operability of the timber sale.

G-066 Governmental Regulatory Actions

a. Risk

Purchaser shall be responsible for any increased operational costs arising from any applicable foreign or domestic governmental regulation or order that does not cause contract performance to become commercially impracticable or that does not substantially frustrate the purpose of the contract. If impracticability or frustration results from Purchaser's failure to comply with this contract, Purchaser shall remain responsible for payment of the total contract price notwithstanding the impracticability or frustration.

b. Sale Area

When portions of the sale area become subject to a foreign or domestic governmental regulation or order that will likely prevent timber harvest for a period that will exceed the expiration date of this contract, and Purchaser has complied with this contract, the following shall apply:

i. RCW 79.15.140 shall govern all adjustments to the contract area.

c. Adjustment of Price

The State shall adjust the total contract price by subtracting from the total contract price an amount determined in the following manner: The State shall cause the timber sale area subject to governmental regulation or order to be measured. The State shall calculate the percentage of the total sale area subject to the governmental regulation or order. The State shall reduce the total contract price by that calculated percentage. However, variations in species, value, costs, or other items pertaining to the affected sale area will be analyzed and included in the adjustment if deemed appropriate by the State. The State will further reduce the total contract price by the reasonable cost of unamortized roads Purchaser constructed but was unable to fully use for removing timber. A reduction in total contract price terminates all of the Purchaser's rights to purchase and remove the timber and all other interest in the affected sale area.

G-070 Limitation on Damage

In the event of a breach of any provision of this contract by the State, the exclusive remedy available to Purchaser will be limited to a return of the initial deposit, unapplied payments, and credit for unamortized improvements made by Purchaser.

The State shall not be liable for any damages, whether direct, incidental or consequential.

G-080 Scope of State Advice

No advice by any agent, employee, or representative of the State regarding the method or manner of performing shall constitute a representation or warranty that said method, manner or result thereof will conform to the contract or be suitable for Purchaser's purposes under the contract. Purchaser's reliance on any State advice regarding the method or manner of performance shall not relieve Purchaser of any risk or obligation under the contract. Purchaser retains the final responsibility for its operations under this contract and State shall not be liable for any injuries resulting from Purchaser's reliance on any State advice regarding the method or manner of performance.

G-091 Sale Area Adjustment

The Parties may agree to adjustments in the sale area boundary. The cumulative changes to the sale area during the term of the contract shall not exceed more than four percent of the original sale area. If the sale area is increased, the added forest products become a part of this contract. The State shall determine the volume added and shall calculate the increase to the total contract price using the rates set forth in clause G-101, G-102, or G-103. If the sale area is reduced, the State shall determine the volume to be reduced. The State shall calculate the reduction to the total contract price using the rates set forth in clause G-101, G-102, or G-103.

G-103 Forest Products Not Designated

Any forest products not designated for removal, which must be removed in the course of operations authorized by the State, shall be approved and designated by the Contract Administrator prior to removal. Added forest products shall become a part of this contract and the Scribner log scale volume, as defined by the Northwest Log Rules Eastside for ponderosa pine and the Northwest Log Rules Advisory Group for all other species, shall be determined by the Contract Administrator. Added forest products shall be paid for at the following contract payment rates per MBF Scribner log scale.

The pricing schedule has not been set for the sale.

G-111 Title and Risk of Loss

Title to the forest products under this contract passes to the Purchaser after they are removed from the sale area, if adequate advance payment or payment security has been provided to the State under this contract. Purchaser bears all risk of loss of, or damage to, and has an insurable interest in, the forest products described in this contract from the time the sale is confirmed under RCW 79.15.120. Breach of this contract shall have no effect on this provision.

G-116 Sustainable Forestry Initiative® (SFI®) Certification

Forest products purchased under this contract are certified as being in conformance with the Sustainable Forestry Initiative 2022 Forest Management Standard under certificate number: BVC-SFIFM-018227.

Purchaser shall have at least one person regularly on-site during active operations that have completed training according to the requirements outlined within the SFI Standard. Purchaser shall designate in writing the name(s) of the individual(s) who will be on-site and provide proof of their successful completion of an approved training program prior to active operations.

G-120 Responsibility for Work

All work, equipment, and materials necessary to perform this contract shall be the responsibility of Purchaser. Any damage to improvements, except as provided in clause G-121 or unless the State issues an operating release pursuant to clause G-280, shall be repaired promptly to the satisfaction of the State and at Purchaser's expense.

G-121 Exceptions

Exceptions to Purchaser's responsibility in clause G-120 shall be limited exclusively to the following. These exceptions shall not apply where road damage occurs due to Purchaser's failure to take reasonable precautions or to exercise sound forest engineering and construction practices.

The State will bear the cost to repair damages caused by a third party. In all other cases, the Purchaser shall bear responsibility for the costs as described below.

Road is defined as the road bed, including but not limited to its component parts, such as cut and fill slopes, subgrade, ditches, culverts, bridges, and cattle guards.

For the purposes of this clause, damage will be identified by the State and is defined as:

1. Failure of (a) required improvements or roads designated in clause C-050, or (b) required or optional construction completed to the point that authorization to haul has been issued;
2. Caused by a single event from forces beyond the control of Purchaser, its employees, agents, or invitees, including independent contractors; and
3. Includes, but is not limited to natural disasters such as earthquakes, volcanic eruptions, landslides, and floods.

The repair work identified by the State shall be promptly completed by Purchaser at an agreed price. The State may elect to accomplish repairs by means of State-provided resources.

For each event, Purchaser shall be solely responsible for the initial \$5,000 in repairs. For repairs in excess of \$5,000, the parties shall share equally the portion of costs between \$5,000 and \$15,000. The State shall be solely responsible for the portion of the cost of repairs that exceed \$15,000.

Nothing contained in clauses G-120 and G-121 shall be construed as relieving Purchaser of responsibility for, or damage resulting from, Purchaser's operations or

negligence, nor shall Purchaser be relieved from full responsibility for making good any defective work or materials. Authorization to haul does not warrant that Purchaser built roads are free from material defect and the State may require additional work, at Purchasers expense regardless of cost, to remedy deficiencies at any time.

G-140 Indemnity

To the fullest extent permitted by law, Purchaser shall indemnify, defend and hold harmless State, agencies of State and all officials, agents and employees of State, from and against all claims arising out of or resulting from the performance of the contract. "Claim" as used in this contract means any financial loss, claim, suit, action, damage, or expense, including but not limited to attorneys' fees, attributable for bodily injury, sickness, disease or death, or injury to or destruction of tangible property including loss of use resulting therefrom. Purchasers' obligations to indemnify, defend, and hold harmless includes any claim by Purchasers' agents, employees, representatives, or any subcontractor or its employees. Purchaser expressly agrees to indemnify, defend, and hold harmless State for any claim arising out of or incident to Purchasers' or any subcontractors' performance or failure to perform the contract. Purchasers' obligation to indemnify, defend, and hold harmless State shall not be eliminated or reduced by any actual or alleged concurrent negligence of State or its agents, agencies, employees and officials. Purchaser waives its immunity under Title 51 RCW to the extent it is required to indemnify, defend and hold harmless State and its agencies, officials, agents or employees.

G-150 Insurance

Purchaser shall, at its cost and expense, buy and maintain insurance of the types and amounts listed below. Failure to buy and maintain the required insurance may result in a breach and/or termination of the contract at State's option. State may suspend Purchaser operations until required insurance has been secured.

All insurance and surety bonds should be issued by companies admitted to do business within the State of Washington and have a rating of A-, Class VII or better in the most recently published edition of Best's Reports. If an insurer is not admitted, all insurance policies and procedures for issuing the insurance policies must comply with Chapter 48.15 RCW and 284-15 WAC.

The State of Washington, Department of Natural Resources region office of sale origin shall be provided written notice before cancellation or non-renewal of any insurance referred to therein, in accord with the following specifications:

1. Insurers subject to Chapter 48.18 RCW (admitted and regulated by the Insurance Commissioner): The insurer shall give the State 45 days advance notice of cancellation or non-renewal. If cancellation is due to non-payment of premium, the State shall be given 10 days advance notice of cancellation.
2. Insurers subject to Chapter 48.15 RCW (surplus lines): The State shall be given 20 days advance notice of cancellation. If cancellation is due to non-

payment of premium, the State shall be given 10 days advance notice of cancellation.

Before starting work, Purchaser shall furnish State of Washington, Department of Natural Resources with a certificate(s) of insurance, executed by a duly authorized representative of each insurer, showing compliance with the insurance requirements specified in the contract. Insurance coverage shall be obtained by the Purchaser prior to operations commencing and continually maintained in full force until all contract obligations have been satisfied or an operating release has been signed by the State.

Purchaser shall include all subcontractors as insured under all required insurance policies, or shall furnish separate certificates of insurance and endorsements for each subcontractor. Subcontractor(s) must comply fully with all insurance requirements stated herein. Failure of subcontractor(s) to comply with insurance requirements does not limit Purchaser's liability or responsibility.

The State of Washington, Department of Natural Resources, its elected and appointed officials, agents and employees shall be named as an additional insured via endorsement on all general liability, excess, umbrella, and property insurance policies.

All insurance provided in compliance with this contract shall be primary as to any other insurance or self-insurance programs afforded to or maintained by State. Purchaser waives all rights against State for recovery of damages to the extent these damages are covered by general liability or umbrella insurance maintained pursuant to this contract.

By requiring insurance herein, State does not represent that coverage and limits will be adequate to protect Purchaser and such coverage and limits shall not limit Purchaser's liability under the indemnities and reimbursements granted to State in this contract.

The limits of insurance, which may be increased as deemed necessary by State of Washington, Department of Natural Resources, shall not be less than as follows:

Commercial General Liability (CGL) Insurance. Purchaser shall maintain general liability (CGL) insurance, and, if necessary, commercial umbrella insurance with a limit of not less than \$1,000,000.00 per each occurrence. If such CGL insurance contains aggregate limits, the General Aggregate limit shall be at least twice the "each occurrence" limit. CGL insurance shall have products-completed operations aggregate limit of at least two times the "each occurrence" limit. CGL coverage shall include a Logging and Lumbering Endorsement (i.e. Logger's Broad-Form) to cover the events that include, but are not limited to, fire suppression expenses, accidental timber trespasses, and wildfire property damage with limits of not less than \$2,000,000.00 each occurrence.

CGL insurance shall be written on Insurance Services Office (ISO) occurrence form CG 00 01 (or a substitute form providing equivalent coverage). All insurance shall cover liability arising out of premises, operations, independent contractors, products

completed operations, personal injury and advertising injury, and liability assumed under an insured contract (including the tort liability of another party assumed in a business contract), and contain separation of insured (cross liability) condition.

Employer's Liability "Stop Gap" Insurance. Purchaser shall buy employers liability insurance, and, if necessary, commercial umbrella liability insurance with limits not less than \$1,000,000.00 each accident for bodily injury by accident or \$1,000,000.00 each employee for bodily injury by disease.

Workers' Compensation Coverage. Purchaser shall comply with all State of Washington workers' compensation statutes and regulations. Workers' compensation coverage shall be provided for all employees of Purchaser and employees of any subcontractor or sub-subcontractor. Coverage shall include bodily injury (including death) by accident or disease, which exists out of or in connection with the performance of this contract. Except as prohibited by law, Purchaser waives all rights of subrogation against State for recovery of damages to the extent they are covered by workers' compensation, employer's liability, commercial general liability, or commercial umbrella liability insurance.

If Purchaser, subcontractor or sub-subcontractor fails to comply with all State of Washington workers' compensation statutes and regulations and State incurs fines or is required by law to provide benefits to or obtain coverage for such employees, Purchaser shall indemnify State. Indemnity shall include all fines, payment of benefits to Purchaser or subcontractor employees, or their heirs or legal representatives, and the cost of effecting coverage on behalf of such employees.

Business Auto Policy (BAP). Purchaser shall maintain business auto liability and, if necessary, commercial umbrella liability insurance with a limit not less than \$1,000,000.00 per accident. Such insurance shall cover liability arising out of "Any Auto". Business auto coverage shall be written on ISO form CA 00 01, or substitute liability form providing equivalent coverage. If necessary the policy shall be endorsed to provide contractual liability coverage and cover a "covered pollution cost or expense" as provided in the 1990 or later editions of CA 00 01. Purchaser waives all rights against State for the recovery of damages to the extent they are covered by business auto liability or commercial umbrella liability insurance.

G-160 Agents

The State's rights and duties will be exercised by the Region Manager at Ellensburg, Washington. The Region Manager will notify Purchaser in writing who is responsible for administering the contract. The Region Manager has sole authority to waive, modify, or amend the terms of this contract in the manner prescribed in clause G-180. No agent, employee, or representative of the State has any authority to bind the State to any affirmation, representation, or warranty concerning the forest products conveyed beyond the terms of this contract.

Purchaser is required to have a person on site during all operations who is authorized to receive instructions and notices from the State. Purchaser shall inform the State in

writing who is authorized to receive instructions and notices from the State, and any limits to this person's authority.

G-170 Assignment and Delegation

No rights or interest in this contract shall be assigned by Purchaser without prior written permission of the State. Any attempted assignment shall be void and ineffective for all purposes unless made in conformity with this paragraph. Purchaser may perform any duty through a delegate, but Purchaser is not thereby relieved of any duty to perform or any liability. Any assignee or delegate shall be bound by the terms of the contract in the same manner as Purchaser.

G-180 Modifications

Waivers, modifications, or amendments of the terms of this contract must be in writing signed by Purchaser and the State.

G-190 Contract Complete

This contract is the final expression of the Parties' agreement. There are no understandings, agreements, or representations, expressed or implied, which are not specified in this contract.

G-200 Notice

Notices required to be given under the following clauses shall be in writing and shall be delivered to Purchaser's authorized agent or sent by certified mail to Purchaser's address of record:

G-210 Violation of Contract

G-220 State Suspends Operations

All other notices required to be given under this contract shall be in writing and delivered to the authorized agent or mailed to the Party's post office address. Purchaser agrees to notify the State of any change of address.

G-210 Violation of Contract

- a. If Purchaser violates any provision of this contract, the Contract Administrator, by written notice, may suspend those operations in violation. If the violation is capable of being remedied, Purchaser has 30 days after receipt of a suspension notice to remedy the violation. If the violation cannot be remedied (such as a violation of WAC 240-15-015) or Purchaser fails to remedy the violation within 30 days after receipt of a suspension notice, the State may terminate the rights of Purchaser under this contract and collect damages.
- b. If the contract expires pursuant to clause G-030 or G-031 without Purchaser having performed all its duties under this contract, Purchaser's right to operate is terminated and Purchaser shall not have the right to remedy the breach. This provision shall not relieve Purchaser of any payment obligations.

- c. The State has the right to remedy the breach in the absence of any indicated attempt by Purchaser or if Purchaser is unable, as determined by the State, to remedy the breach. Any expense incurred by the State shall be charged to Purchaser and shall be paid within 30 days of receipt of billing.
- d. If Purchaser's violation is a result of a failure to make a payment when due, in addition to a. and b. above, interest shall accrue on the unpaid balance at 12 percent per annum, beginning the date payment was due.

G-220 State Suspends Operations

The Contract Administrator may suspend any operation of Purchaser under this contract when the State is suffering, or there is a reasonable expectation the State will suffer environmental, monetary, or other damage if the operation is allowed to continue.

Purchaser shall be in breach of this contract if the operation continues after the suspension notice or if the operation resumes without prior approval and notice from the Contract Administrator.

Purchaser may request a modification of a suspension within 30 days of the start of suspension through the dispute resolution process in clause G-240. If this process results in a finding that the suspension exceeded the time reasonably necessary to stop or prevent damage to the State, Purchaser is entitled to request a contract term adjustment under clause G-040.

If it reasonably appears that the damage that the State is suffering, or can reasonably be expected to suffer if the operation is allowed to continue, will prevent harvest for a period that will exceed 6 months, and Purchaser has complied with this contract, the provisions of clause G-066 shall govern just as if the harvest was prevented by an applicable foreign or domestic governmental regulation or order.

G-230 Unauthorized Activity

Any cutting, removal, or damage of forest products by Purchaser, its employees, agents, or invitees, including independent contractors, in a manner inconsistent with the terms of this contract or State law, is unauthorized. Such activity may subject Purchaser to liability for triple the value of said forest products under RCW 79.02.320 or RCW 79.02.300 and may result in prosecution under RCW 79.02.330 or other applicable statutes.

G-240 Dispute Resolution

The following procedures apply in the event of a dispute regarding interpretation or administration of this contract and the parties agree that these procedures must be followed before a lawsuit can be initiated.

- a. In the event of a dispute, Purchaser must make a written request to the Region Manager for resolution prior to seeking other relief.

- b. The Region Manager will issue a written decision on Purchaser's request within ten business days.
- c. Within ten business days of receipt of the Region Manager's decision, Purchaser may make a written request for resolution to the Deputy Supervisor - Uplands of the Department of Natural Resources.
- d. Unless otherwise agreed, a conference will be held by the Deputy Supervisor - Uplands within 30 calendar days of the receipt of Purchaser's request for review of the Region Manager's written decision. Purchaser and the Region Manager will have an opportunity to present their positions. The Deputy Supervisor - Uplands will issue a decision within a reasonable time of being presented with both Parties' positions.

G-250 Compliance with All Laws

Purchaser shall comply with all applicable statutes, regulations and laws, including, but not limited to; chapter 27.53 RCW, chapter 68.50 RCW, WAC 240-15 and WAC 296-54. Failure to comply may result in forfeiture of this contract.

G-260 Venue

This contract shall be governed by the laws of the State of Washington. In the event of a lawsuit involving this contract, venue shall be proper only in Thurston County Superior Court.

G-270 Equipment Left on State Land

All equipment owned or in the possession of Purchaser, its employees, agents, or invitees, including independent contractors, shall be removed from the sale area and other State land by the termination date of this contract. Equipment remaining unclaimed on State land 60 days after the expiration of the contract period is subject to disposition as provided by law. Purchaser shall pay to the State all costs of moving, storing, and disposing of such equipment. The State shall not be responsible for any damages to or loss of the equipment or damage caused by the moving, storing or disposal of the equipment.

G-280 Operating Release

An operating release is a written document, signed by the State and Purchaser, indicating that Purchaser has been relieved of certain rights or responsibilities with regard to the entire or a portion of the timber sales contract. Purchaser and State may agree to an operating release for this sale, or portion of this sale, prior to the contract expiration, when all contract requirements pertaining to the release area have been satisfactorily completed. Upon issuance of a release, Purchaser's right to cut and remove forest products on the released area will terminate.

G-310 Road Use Authorization

Purchaser is authorized to use the following State roads and roads for which the State has acquired easements and road use permits; H3900, H3910, and H3911. The State

may authorize in writing the use of other roads subject to fees, restrictions, and prior rights.

G-330 Pre-work Conference

Purchaser shall arrange with the Contract Administrator to review this contract and to examine the sale area before beginning any operations. A plan of operations shall be developed and agreed upon by the Contract Administrator and Purchaser before beginning any operations. To the extent that the plan of operations is inconsistent with the contract, the terms of the contract shall prevail. State's acceptance and approval of Purchaser's plan of operations shall not be construed as any statement or warranty that the plan of operations is adequate for Purchaser's purposes or complies with applicable laws.

G-340 Preservation of Markers

Any legal land subdivision survey corners and witness objects are to be preserved. If such are destroyed or disturbed, the Purchaser shall, at the Purchaser's own expense, re-establish them through a licensed land surveyor in accordance with U.S. General Land Office standards. Corners and/or witness objects that must be disturbed or destroyed in the process of road construction or logging shall be adequately referenced and/or replaced in accordance with RCW 58.24.040(8). Such references must be approved by the Contract Administrator prior to removal of said corners and/or witness objects.

G-360 Road Use Reservation

The State shall have the right to use, without charge, all existing roads and any road constructed or reconstructed on State lands by Purchaser under this contract. The State may extend such rights to others. If the State grants such rights to others, the State shall require performance or payment, as directed by the State, for their proportionate share of maintenance based on their use.

G-370 Blocking Roads

Purchaser shall not block the H3900, unless authority is granted in writing by the Contract Administrator.

G-430 Open Fires

Purchaser shall not set, or allow to be set by Purchaser's employees, agents, invitees and independent contractors, any open fire at any time of the year without first obtaining permission, in writing, from the Contract Administrator.

G-450 Encumbrances

This contract and Purchaser's activities are subject to the following:

Water Right, including the terms and provisions thereof,

For: Stream

In Favor of: DNR

Disclosed by Application No.: 78-004381

Granted: 5/15/1974

Expires: Indefinite

Lease, including the terms and provisions thereof,
For: Genetically Selected Trees
In Favor of: DNR – Webster Nursery
Disclosed by Application No.: 91-001100
Granted: 8/14/1984
Expires: 12/31/2050

Special Notations: Located within Forest Health Hazard Warning Designation area.
Commissioner's Order #201225, 8/22/2012.

Section P: Payments and Securities

P-011 Initial Deposit

Purchaser paid DATA MISSING initial deposit, which will be maintained pursuant to RCW 79.15.100(3). If the operating authority on this contract expires without Purchaser's payment of the full amount specified in Clause P-020, the initial deposit will be immediately forfeited to the State, and will be offset against Purchaser's remaining balance due. Any excess initial deposit funds not needed to ensure full payment of the contract price, or not needed to complete any remaining obligations of the Purchaser existing after contract expiration, will be refunded to the Purchaser.

P-020 Payment for Forest Products

Purchaser agrees to pay the total, lump sum contract price of \$26,416.00. The total contract price consists of a \$0.00 contract bid price plus \$26,416.00 in fees. Fees collected shall be retained by the state unless the contract is adjusted via the G-066 clause. Purchaser shall be liable for the entire purchase price, and will not be entitled to any refunds or offsets unless expressly stated in this contract.

THE PURCHASE PRICE SHALL NOT BE AFFECTED BY ANY FACTORS, INCLUDING: the amount of forest products actually present within the contract area, the actual acreage covered by the contract area, the amount or volume of forest products actually cut or removed by purchaser, whether it becomes physically impossible or uneconomic to remove the forest products, and whether the subject forest products have been lost or damaged by fire or any other cause. The only situations Purchaser may not be liable for the full purchase price are governed by clause G-066, concerning governmental regulatory actions taken during the term of the contract.

P-045 Guarantee of Payment

Purchaser will pay for forest products prior to cutting or will guarantee payment by posting an approved payment security. The amount of cash or payment security shall be determined by the State and shall equal or exceed the value of the cutting proposed by Purchaser.

P-050 Billing Procedure

The State will compute and forward to Purchaser statements of charges provided for in the contract. Purchaser shall deliver payment to the State on or before the date shown on the billing statement.

P-070 Payment for Products: Damage, Theft, Loss, or Mismatch

Forest products included in this agreement which are destroyed, damaged, stolen, lost, or mismatched shall be paid for by Purchaser on demand of the State. The rates contained in clause P-020 shall apply.

P-080 Payment Account Refund

Advance payments made under P-045 or P-045.2 remaining on account above the value for the charges shall be returned to Purchaser within 30 days following the final report of charges. Refunds not made within the 30 day period will accrue interest at the interest rate, as established by WAC 332-100-030, computed on a daily basis until paid.

P-090 Performance Security

Purchaser agrees to furnish, within 30 days of the confirmation date, security acceptable to the State in the amount of \$45,200.00. The Security provided shall guarantee performance of all provisions of this contract and payment of any damages caused by operations under this contract or resulting from Purchaser's noncompliance with any rule or law. Acceptable performance security may be in the form of a performance bond, irrevocable letter of credit, cash, savings or certificate of deposit account assignments, and must name the State as the obligee or beneficiary. A letter of credit must comply with Title 62A RCW, Article 5. Performance security must remain in full force over the duration of the contract length. Surety bonds issued shall conform to the issuance and rating requirements in clause G-150. The State shall retain the performance security pursuant to RCW 79.15.100. Purchaser shall not operate unless the performance security has been accepted by the State. If at any time the State decides that the security document or amount has become unsatisfactory, Purchaser agrees to suspend operations and, within 30 days of notification, to replace the security with one acceptable to the State or to supplement the amount of the existing security.

P-100 Performance Security Reduction

The State may reduce the performance security after an operating release has been issued if the State determines that adequate security exists for any remaining obligations of Purchaser.

Section H: Harvesting Operations**H-001 Operations Outside the Sale Boundaries**

No operations shall occur outside the sale boundaries, as described within the contract, unless approved in writing by the State.

H-010 Cutting and Yarding Schedule

Felling and Yarding will not be permitted from November 1 to April 30 unless authorized in writing by the Contract Administrator.

H-013 Reserve Tree Damage Definition

Reserve trees are trees required and designated for retention within the sale boundary. Purchaser shall protect reserve trees from being cut, damaged, or removed during operations.

Reserve tree damage exists when one or more of the following criteria occur as a result of Purchaser's operation, as determined by the Contract Administrator:

- a. A reserve tree has one or more scars on its trunk exposing the cambium layer, which in total exceeds 144 square inches.
- b. A reserve tree top is broken or the live crown ratio is reduced below 30 percent.
- c. A reserve tree has more than 1/3 of the circumference of its root system injured such that the cambium layer is exposed.

If the Contract Administrator determines that a reserve tree has been cut or damaged, the Purchaser shall provide a replacement reserve tree of like condition, size, and species within the sale unit containing the damaged leave tree, as approved by the Contract Administrator. Purchaser may be required to pay liquidated damages for Excessive Reserve Tree Damage as detailed in clause D-041.

Removal of designated reserve trees from the sale area is unauthorized, and may invoke the use of the G-230 'Unauthorized Activity' clause. Purchaser is required to leave all cut or damaged reserve trees on site.

H-015 Skid Trail Requirements

A skid trail is defined as an area that is used for more than three passes by any equipment.

Purchaser shall comply with the following during the yarding operation:

- a. Skid trails will not exceed 18 feet in width, including rub trees.
- b. Skid trails shall not cover more than 20 percent of the total acreage on one unit.
- c. Skid trail location will be pre-approved by the Contract Administrator.
- d. Except for rub trees, skid trails shall be felled and yarded prior to the felling of adjacent timber.
- e. Rub trees shall be left standing until all timber tributary to the skid trail has been removed.
- f. Excessive soil damage is not permitted. Excessive soil damage is described in clause H-017.
- g. Skid trails will be water barred at the time of completion of yarding, if required by the Contract Administrator.

Purchaser shall not deviate from the requirements set forth in this clause without prior written approval from the Contract Administrator.

H-017 Preventing Excessive Soil Disturbance

Operations may be suspended when soil rutting exceeds 4 inches as measured from the natural ground line. To reduce soil damage, the Contract Administrator may require water bars to be constructed, grass seed to be placed on exposed soils, or other mitigation measures. Suspended operations shall not resume unless approval to do so has been given, in writing, by the Contract Administrator.

H-035 Fall Trees Into Sale Area

Trees shall be felled into the sale area unless otherwise approved by the Contract Administrator.

H-040 Purchaser Harvest Plan

Purchaser shall, as part of the plan of operations, prepare an acceptable harvest plan for the timber sale. The plan shall address the landing locations, skid trail design, S-030 clause, and C-040 clause: Section 9 of the Road Plan, which are part(s) of this contract. The harvest plan shall be approved by the Contract Administrator prior to beginning the harvest operation. Purchaser shall not deviate from the harvest plan without prior written approval by the Contract Administrator.

H-051 Branding and Painting

Purchaser shall provide a State of Washington registered log brand, acceptable to the State, unless the State agrees to furnish the brand. All purchased timber shall be branded in a manner that meets the requirements of WAC 240-15-030(2)(a)(i). All timber purchased under a contract designated as export restricted shall also be painted in a manner that meets the requirements of WAC 240-15-030(2)(a)(ii).

For pulp loads purchased under a contract designated as export restricted, Purchaser shall brand at least 3 logs with legible brands at one end. Also, 10 logs shall be painted at one end with durable red paint.

H-080 Snags Not to be Felled

Snags not required to be felled for safety reasons may be left standing. Snags felled for safety reasons shall not be removed and must remain where felled.

H-120 Harvesting Equipment

Forest products sold under this contract shall be harvested and removed using ground based equipment. Authority to use other equipment or to operate outside the equipment specifications detailed above must be approved in writing by the State.

H-130 Hauling Schedule

The hauling of forest products will not be permitted from November 1 to April 30 unless authorized in writing by the Contract Administrator.

H-140 Special Harvest Requirements

Purchaser shall accomplish the following during the harvest operations:

(1) Create short snags of approximately 20 ft. in height with the feller buncher from trees identified with a double blue ring.

(2) Cull logs that are greater than 10 inches in diameter by a length of 12 feet must be brought back into the unit.

Permission to do otherwise must be granted in writing by the Contract Administrator.

H-141 Additional Harvest Requirements

Purchaser shall accomplish the following during the harvest operations:

If a northern goshawk is identified in the sale area the Contract Administrator and Region Biologist must be immediately notified.

If a Gray Wolf den site is discovered or suspected within 1 mile of the timber sale, a no-harvest temporary seasonal timing restriction will be enforced immediately for the duration of March 15 through July 30.

Permission to do otherwise must be granted in writing by the State.

H-190 Completion of Settings

Operations begun on any setting of the sale area shall be completed before any operation begins on subsequent settings unless authorized in writing by the Contract Administrator.

H-220 Protection of Residual or Adjacent Trees

Unless otherwise specified by this contract, the Contract Administrator shall identify damaged adjacent or leave trees that shall be paid for according to clause G-230.

Section C: Construction and Maintenance

C-040 Road Plan

Road construction and associated work provisions of the Road Plan for this sale, dated 2/8/2024 are hereby made a part of this contract.

C-050 Purchaser Road Maintenance and Repair

Purchaser shall perform work at their own expense on H3900, H3910, and H3911. All work shall be completed to the specifications detailed in the Road Plan.

C-080 Landing Locations Approved Prior to Construction

Landings shall be marked by Purchaser and approved by the Contract Administrator prior to construction.

C-140 Water Bars

Purchaser shall, as directed by the Contract Administrator, construct water bars across haul roads, skid trails and fire trails as necessary to control soil erosion and water pollution.

Section S: Site Preparation and Protection

S-001 Emergency Response Plan

An Emergency Response Plan (ERP) shall be provided to the Contract Administrator containing but not limited to, valid contact numbers and procedures for medical emergencies, fire, hazardous spills, forest practice violations and any unauthorized or unlawful activity on or in the vicinity of the sale area. The Contract Administrator and the State shall be promptly notified whenever an incident occurs requiring an emergency response.

The ERP must be presented for inspection at the prework meeting and kept readily available to all personnel, including subcontractors, on site during active operations.

S-010 Fire Hazardous Conditions

Purchaser acknowledges that operations under this Contract may increase the risk of fire. Purchaser shall conduct all operations under this agreement following the requirements of WAC 332-24-005 and WAC 332-24-405 and further agrees to use the highest degree of care to prevent uncontrolled fires from starting.

In the event of an uncontrolled fire, Purchaser agrees to provide equipment and personnel working at the site to safely and effectively engage in first response fire suppression activity.

Purchaser's failure to effectively engage in fire-safe operations is considered a breach and may result in suspension of operations.

S-030 Landing Debris Clean Up

Landing debris shall be disposed of in a manner approved in writing by the Contract Administrator.

S-035 Logging Debris Clean Up

Slash and debris created from harvest activities shall be treated in a manner approved in writing by the Contract Administrator.

S-040 Noxious Weed Control

Purchaser shall notify the Contract Administrator in advance of moving equipment onto State lands. Purchaser shall thoroughly clean all off road equipment prior to entry onto State land to remove contaminated soils and noxious weed seed. If equipment is

moved from one DNR project area to another, the Contract Administrator reserves the right to require the cleaning of equipment. Equipment shall be cleaned at a location approved by the Contract Administrator.

S-060 Pump Truck or Pump Trailer

Purchaser shall provide a fully functional pump truck or pump trailer equipped to meet the specifications of WAC 332-24-005 and WAC 332-24-405 during the "closed season" or as extended by the State and shall provide trained personnel to operate this equipment on the sale area during all operating periods.

S-120 Stream Protection

No timber shall be felled into, across, or yarded through the Np creek.

S-130 Hazardous Materials

a. Hazardous Materials and Waste - Regulatory Compliance

Purchaser is responsible for understanding and complying with all applicable local, state, and federal hazardous material/waste laws and regulations for operations conducted under this contract. Such regulations pertain to, but may not be limited to, hazardous material storage, handling and transport, personnel protection, release notification and emergency response, cleanup, and waste disposal.

Purchaser shall be responsible for restoring the site in the event of a spill or other releases of hazardous material/waste during operations conducted under this contract.

b. Hazardous Materials Spill Prevention

All operations shall be conducted in a manner that avoids the release of hazardous materials, including petroleum products, into the environment (water, air or land).

c. Hazardous Materials Spill Containment, Control and Cleanup

If safe to do so, Purchaser shall take immediate action to contain and control all hazardous material spills. Purchaser shall ensure that enough quick response spill kits capable of absorbing 10 gallons of oil, coolant, solvent or contaminated water are available on site to quickly address potential spills from any piece of equipment at all times throughout active operations. If large quantities of bulk fuel/other hazardous materials are stored on site, Purchaser must be able to effectively control a container leak and contain & recover a hazmat spill equal to the largest single on site storage container volume. (HAZWOPER reg. 29CFR 1910.120 (j) (1) (vii)).

d. Hazardous Material Release Reporting

Releases of oil or hazardous materials to the environment must be reported according to the State Department of Ecology (ECY). It is the responsibility of the Purchaser to have all emergency contact information readily available and a means of remote communication for purposes of quick notification. In the event of a spill covered in part a., the Purchaser is responsible for immediately notifying all the following:

- Department of Emergency Management at 1-800-258-5990
- National Response Center at 1-800-424-8802
- Appropriate Department of Ecology (ECY) at 1-800-645-7911
- DNR Contract Administrator

S-131 Refuse Disposal

As required by RCW 70.93, All Purchaser generated refuse shall be removed from state lands for proper disposal prior to termination of this contract. No refuse shall be burned, buried or abandoned on state forest lands. All refuse shall be transported in a manner such that it is in compliance with RCW 70.93 and all loads or loose materials shall be covered/secured such that these waste materials are properly contained during transport.

Section D: Damages

D-013 Liquidated Damages or Failure to Perform

The following clauses provide for payments by Purchaser to the State for breaches of the terms of this contract other than failure to perform. These payments are agreed to as liquidated damages and not as penalties. They are reasonable estimates of anticipated harm to the State, which will be caused by Purchaser's breach. These liquidated damages provisions are agreed to by the State and Purchaser with the understanding of the difficulty of proving loss and the inconvenience or infeasibility of obtaining an adequate remedy. These liquidated damages provisions provide greater certainty for the Purchaser by allowing the Purchaser to better assess its responsibilities under the contract.

Clause P-020 governs Purchaser's liability in the event Purchaser fails to perform any of the contract requirements other than the below liquidated damage clauses without written approval by the State. Purchaser's failure to pay for all or part of the forest products sold in this contract prior to expiration of the contract term results in substantial injury to the State. Therefore, Purchaser agrees to pay the State the full lump sum contract price in P-020 in the event of failure to perform.

D-041 Reserve Tree Excessive Damage

When Purchaser's operations exceed the damage limits set forth in clause H-013, Reserve Tree Damage Definition, and when the Contract Administrator determines that a suitable replacement for a damaged reserve tree is not possible, the damaged trees result in substantial injury to the State. The value of the damaged reserve trees at the time of the breach is not readily ascertainable. Therefore, the Purchaser agrees to pay

the State as liquidated damages at the rate of \$1,000.00 per tree for all damaged reserve trees that are not replaced in Unit 1.

SIGNATURES

This agreement may be executed in any number of counterparts (including by electronic mail in portable document format (.pdf), or by facsimile) each of which shall be deemed an original but all of which, when taken together, shall constitute one and the same Agreement binding on all parties.

IN WITNESS WHEREOF, the Parties hereto have entered into this contract.

STATE OF WASHINGTON
DEPARTMENT OF NATURAL RESOURCES

Purchaser

Larry Leach. Acting
Southeast Region Manager

Print Name

Date: _____

Date: _____

Address:

CORPORATE ACKNOWLEDGEMENT
(Required for both LLC and Inc. Entities)

STATE OF _____)

COUNTY OF _____)

On this _____ day of _____, 20____, before me personally appeared _____

_____ to me known to be the _____ of the corporation that executed the within and foregoing instrument and acknowledged said instrument to be the free and voluntary act and deed of the corporation, for the uses and purposes therein mentioned, and on oath stated that (he/she was) (they were) authorized to execute said instrument.

IN WITNESS WHEREOF, I have hereunto set my hand and affixed my official seal the day and year first above written.

Notary Public in and for the State of

My appointment expires _____



WASHINGTON STATE DEPARTMENT OF NATURAL RESOURCES
FOREST EXCISE TAX ROAD SUMMARY SHEET

Region:

Timber Sale Name:

Application Number:

EXCISE TAX APPLICABLE ACTIVITIES

Construction: **linear feet**
Road to be constructed (optional and required) but not abandoned

Reconstruction: **linear feet**
Road to be reconstructed (optional and required) but not abandoned

Abandonment: **linear feet**
Abandonment of existing roads not reconstructed under the contract

Decommission: **linear feet**
Road to be made undriveable but not officially abandoned.

Pre-Haul Maintenance: **linear feet**
Existing road to receive maintenance work (optional and required) prior to haul

EXCISE TAX EXEMPT ACTIVITIES

Temporary Construction: **linear feet**
Roads to be constructed (optional and required) and then abandoned

Temporary Reconstruction: **linear feet**
Roads to be reconstructed (optional and required) and then abandoned

All parties must make their own assessment of the taxable or non-taxable status of any work performed under the timber sale contract. The Department of Revenue bears responsibility for determining forest road excise taxes. The Department of Natural Resources developed this form to help estimate the impact of forest excise taxes. However, the information provided may not precisely calculate the actual amount of taxes due. The Department of Revenue is available for consultation by calling 1.800.548.8829.

(Revised 9/18)

PRE-CRUISE NARRATIVE

Sale Name: LIBERTY	Region: Southeast
Agreement #: 30-106233	District: Klickitat
Contact Forester: Bryan Inglin Phone / Location: (509) 201-2562	County(s): Klickitat
Alternate Contact: Albert Durkee Phone / Location: (541) 490-3678	Other information:

Type of Sale: Lump Sum	
Harvest System: Ground based	Unit 1: 100%

UNIT ACREAGES AND METHOD OF DETERMINATION:

Unit # Harvest R/W or RMZ WMZ	Legal Description (Enter only one legal for each unit) Sec/Twp/Rng	Grant or Trust	Gross Proposal Acres	Deductions from Gross Acres (No harvest acres)				Net Harvest Acres	Acreage Determination (List method and error of closure if applicable)
				RMZ/ WMZ Acres	Leave Tree Acres	Existing Road Acres	Other Acres (describe)		
1	Sec. 3 T4N R12E	01	68.5	4	4.5	-	-	60	GPS (Garmin)
TOTAL ACRES								60	

HARVEST PLAN AND SPECIAL CONDITIONS:

Unit #	Harvest Prescription: (Leave, take, paint color, tags, flagging etc.)	Special Management areas:	Other conditions (# leave trees, etc.)
1	White timber sale boundary tags, and pink flagging. Leave trees marked with blue paint rings.	Leave Tree Areas marked with yellow LTA boundary tags and pink flagging.	Leave Trees = 13/ac Individual LTs: 459 (~8/ac) Clumped LTs: 319 (~5/ac.) Total Leave Trees: 778

OTHER PRE-CRUISE INFORMATION:

Unit #	Primary,secondary Species / Estimated Volume (MBF)	Access information (Gates, locks, etc.)	Photos, traverse maps required
1	Douglas-fir, grand fir 1,000 MBF	The unit is approximately 5 miles north of Appleton, WA. Cattle gate at 0+30 on the H3900 Road. Unit is accessible from the H3900/H3910 junction.	
TOTAL MBF	1,000 MBF		

REMARKS:

The H3900 Road is a dirt road and can be impassable when wet. Best access is May – October.

Prepared By: Bryan Inglin Date: 1/17/2024	Title: Forester	CC:
--	------------------------	------------

Timber Sale Cruise Report Liberty

Sale Name: LIBERTY

Sale Type: LUMP SUM

Region: SOUTHEAST

District: KLICKITAT

Lead Cruiser: Bryan Inglin

Other Cruisers:

Cruise Narrative:

Location:

The sale is approximately # miles north of Appleton, WA and can be accessed via the H3900 state lands road directly from Canyon road. The legal description for the timber sale is Sec. 3 of Township 4N Range 12E.

Cruise Design: Variable Plots.

Almost 1 Plot/1 acres

All 52 plots were cruised using a 46.94 BAF and 160 BAF for selecting cruise trees on plots. All stems ≥ 10 " DBH were cruised. There are three species present on this sale: Douglas-fir (DF), grand fir (GF), and a minor component of ponderosa pine (PP).

Log Length - All species utilized 40' logs when possible, with a minimum log length of 16'. Top bole height for all species was cruised to 40% FP at 16'.

Take/Leave Prescription - The silvicultural prescription for this timber sale is a Seed Tree harvest leaving approximately 13 trees per acre at a variable spacing identified by a blue paint ring or bound by a leave tree area tag. Take all trees ≥ 10 " not painted.

Timber Quality:

Removal volume is 77% DF/22% GF/ 1% PP.

Stand age is approximately 50-60 years old.

Defect primarily occurred in GF due to root rot in lower the bole, as well as dwarf mistletoe and freeze/thaw cracks in the upper bole.

Logging and Stand Conditions:

The majority of the sale is flat with gentle to moderate slopes of less than 15%, the steepest slopes occur within the draws with pitches of up to 35%. The sale is set up primarily for favorable logging however, some adverse skidding will be required.

Timber Sale Notice Volume (MBF)

Sp	DBH	Rings/In	Age	MBF Volume by Grade					Utility
				All	2 Saw	3 Saw	4 Saw	5 Saw	
DF	15.7		55	781	182	522	76		
GF	14.0			228	28	143	27		29
PP	19.2			7			5	2	
ALL	15.2		55	1,016	211	666	108	2	29

Timber Sale Notice Weight (tons)

Sp	Tons by Grade					
	All	2 Saw	3 Saw	4 Saw	5 Saw	Utility
DF	6,807	1,431	4,789	587		
GF	2,191	221	1,519	197		255
PP	36			27	10	
ALL	9,035	1,652	6,307	810	10	255

Timber Sale Overall Cruise Statistics

BA (sq ft/acre)	BA SE (%)	V-BAR (bf/sq ft)	V-BAR SE (%)	Net Vol (bf/acre)	Vol SE (%)
199.5	6.2	105.3	4.0	21,016	7.4

Timber Sale Unit Cruise Design

Unit	Design	Cruise Acres	FMA Acres	N Plots	N Cruise Plots	N Void Plots
LIBERTY U1	BBL: VR, Big BAF (160 Measure, 46.94 Count) Sighting Ht = 4.5 ft	60.0	64.3	52	52	0
All		60.0	64.3	52	52	0

Timber Sale Log Grade x Sort Summary

Sp	Status	Grade	Sort	Dia	Len	BF Gross	BF Net	Defect %	Tons	MBF Net
DF	LIVE	2 SAW	Domestic	13.6	40	3,038	3,038	0.0	1,431.2	182.3
DF	LIVE	3 SAW	Domestic	8.2	39	8,706	8,706	0.0	4,788.9	522.4
DF	LIVE	4 SAW	Domestic	5.8	22	1,274	1,274	0.0	587.2	76.4
GF	LIVE	2 SAW	Domestic	15.9	29	508	475	6.6	220.8	28.5
GF	LIVE	3 SAW	Domestic	7.7	40	2,699	2,389	11.5	1,518.5	143.4
GF	LIVE	4 SAW	Domestic	5.7	19	451	443	1.9	196.6	26.6
GF	LIVE	CULL	Cull	11.7	6	445	0	100.0	0.0	0.0
GF	LIVE	UTILITY	Pulp	6.1	35	490	490	0.0	255.2	29.4
PP	LIVE	4 SAW	Domestic	11.7	32	87	87	0.0	26.5	5.2
PP	LIVE	5 SAW	Domestic	6.1	32	26	26	0.0	9.7	1.6

Timber Sale Log Sort x Diameter Bin Summary

Sp	Bin	Status	Sort	Dia	Len	BF Net	Defect %	Tons	MBF Net
DF	5 - 8	LIVE	Domestic	6.5	31	5,242	0.0	2,925.4	314.5
DF	9 - 11	LIVE	Domestic	10.0	40	4,738	0.0	2,450.8	284.3
DF	12 - 14	LIVE	Domestic	13.3	40	2,340	0.0	1,141.0	140.4
DF	15 - 19	LIVE	Domestic	15.1	40	698	0.0	290.2	41.9
GF	5 - 8	LIVE	Pulp	6.1	35	490	0.0	255.2	29.4
GF	5 - 8	LIVE	Domestic	6.8	32	2,513	9.8	1,486.1	150.8
GF	5 - 8	LIVE	Cull	8.6	8	0	100.0	0.0	0.0
GF	9 - 11	LIVE	Domestic	10.7	40	319	12.0	229.0	19.1
GF	9 - 11	LIVE	Cull	11.5	7	0	100.0	0.0	0.0
GF	12 - 14	LIVE	Cull	13.1	6	0	100.0	0.0	0.0
GF	12 - 14	LIVE	Domestic	14.4	40	298	10.1	151.3	17.9
GF	15 - 19	LIVE	Cull	17.3	1	0	100.0	0.0	0.0
GF	15 - 19	LIVE	Domestic	17.6	16	177	0.0	69.5	10.6
PP	5 - 8	LIVE	Domestic	6.1	32	26	0.0	9.7	1.6
PP	9 - 11	LIVE	Domestic	11.7	32	87	0.0	26.5	5.2

Cruise Unit Report LIBERTY U1

Unit Sale Notice Volume (MBF): LIBERTY U1

Sp	DBH	Rings/In	Age	MBF Volume by Grade					Utility
				All	2 Saw	3 Saw	4 Saw	5 Saw	
DF	15.7		55	781	182	522	76		
GF	14.0			228	28	143	27		29
PP	19.2			7			5	2	
ALL	15.2		55	1,016	211	666	108	2	29

Unit Sale Notice Weight (tons): LIBERTY U1

Sp	Tons by Grade					Utility
	All	2 Saw	3 Saw	4 Saw	5 Saw	
DF	6,807	1,431	4,789	587		
GF	2,191	221	1,519	197		255
PP	36			27	10	
ALL	9,035	1,652	6,307	810	10	255

Unit Cruise Design: LIBERTY U1

Design	Cruise Acres	FMA Acres	N Plots	N Cruise Plots	N Void Plots
BBL: VR, Big BAF (160 Measure, 46.94 Count) Sighting Ht = 4.5 ft	60.0	64.3	52	52	0

Unit Cruise Summary: LIBERTY U1

Sp	Cruised Trees	All Trees	Trees/Plot	Ring-Count Trees
DF	39	161	3.1	0
GF	17	59	1.1	0
PP	1	1	0.0	0
ALL	57	221	4.3	0

Unit Cruise Statistics: LIBERTY U1

Sp	BA (sq ft/acre)	BA CV (%)	BA SE (%)	V-BAR (bf/sq ft)	V-BAR CV (%)	V-BAR SE (%)	Net Vol (bf/acre)	Vol CV (%)	Vol SE (%)
DF	145.3	68.1	9.4	116.3	22.1	3.5	16,902	71.6	10.1
GF	53.3	117.1	16.2	75.1	37.0	9.0	4,000	122.8	18.6

Sp	BA (sq ft/acre)	BA CV (%)	BA SE (%)	V-BAR (bf/sq ft)	V-BAR CV (%)	V-BAR SE (%)	Net Vol (bf/acre)	Vol CV (%)	Vol SE (%)
PP	0.9	721.1	100.0	125.4	0.0	0.0	113	721.1	100.0
ALL	199.5	44.4	6.2	105.3	30.6	4.0	21,016	53.9	7.4

Unit Summary: LIBERTY U1

Sp	Status	Rx	N	D	DBH	BL	THT	BF Gross	BF Net	Defect %	TPA	BA	RD	MBF Net
DF	LIVE	CUT	39	ALL	16.0	66	82	13,018	13,018	0.0	80.2	111.9	28.0	781.1
GF	LIVE	CUT	17	ALL	14.2	63	79	4,593	3,797	17.3	46.0	50.6	13.4	227.8
PP	LIVE	CUT	1	ALL	19.2	69	91	113	113	0.0	0.4	0.9	0.2	6.8
ALL	LIVE	CUT	57	ALL	15.4	65	81	17,724	16,928	4.5	126.6	163.4	41.6	1,015.7
ALL	ALL	ALL	57	ALL	15.4	65	81	17,724	16,928	4.5	126.6	163.4	41.6	1,015.7



COPY

Forest Practices Application/Notification Notice of Decision

FPA/N No: 2707624
Effective Date: 4/2/2024
Expiration Date: 4/2/2027
Shut Down Zone: 609W
EARR Tax Credit: [X] Eligible [] Non-eligible
Reference: WADNR-Liberty
Sec 3 T4N R12E

Decision

- [] Notification Accepted Operations shall not begin before the effective date.
[X] Approved This Forest Practices Application is subject to the conditions listed below.
[] Disapproved This Forest Practices Application is disapproved for the reasons listed below.
[] Withdrawn Applicant has withdrawn the Forest Practices Application/Notification (FPA/N).
[] Closed All forest practices obligations are met.

FPA/N Classification

[] Class II [X] Class III [] Class IVG [] Class IVS

Number of Years Granted on Multi-Year Request

[] 4 years [] 5 years

Conditions on Approval/Reasons for Disapproval

NO CONDITIONS.

NOTE: Western Gray Squirrels (WGS) and/or WGS habitat may exist within or adjacent to the FPA proposal. WGS is a protected species in Washington (WAC 220-200-100). For assistance in protecting any WGS nests or habitat, contact Amber Johnson from WDFW at (360) 701-2738. For additional information see WDFW's internet web page for the Western Gray Squirrel: https://wdfw.wa.gov/species-habitats/species/sciurus-griseus

Issued By: Steve Crow

Region: Southeast

Title: Forest Practices Forester

Date: 04/02/2024

Copies to: [] Landowner, Timber Owner and Operator

Issued in person: [X] LO [] TO [] OP By: Brenda Young

Date: 4/2/2024

STATE OF WASHINGTON
DEPARTMENT OF NATURAL RESOURCES

LIBERTY TIMBER SALE ROAD PLAN
KLICKITAT COUNTY
SOUTHEAST REGION

AGREEMENT NO.: 30-106233

STAFF ENGINEER: TARA BAKER

DATE: FEBRUARY 8, 2024

SECTION 0 – SCOPE OF PROJECT

0-1 ROAD PLAN SCOPE

Clauses in this road plan apply to all road related work, including landings and rock acquisition, unless otherwise noted.

0-2 REQUIRED ROADS

The specified work on the following roads is required.

<u>Road</u>	<u>Stations</u>	<u>Type</u>
H3900	0+00 to 58+70	Pre-haul Maintenance
H3910	0+00 to 14+20	Pre-haul Maintenance
	14+20 to 30+85	Reconstruction
H3911	0+00 to 23+50	Reconstruction

0-5 RECONSTRUCTION

This project includes, but is not limited to the following reconstruction requirements:

<u>Road</u>	<u>Stations</u>	<u>Requirements</u>
H3910	14+20 to 30+85	Clearing, grubbing, subgrade widening, compaction, debris disposal, and culvert cleaning.
H3911	0+00 to 23+50	Clearing, grubbing, compaction, subgrade widening, debris disposal, reconstruction of road prism per slope stakes.

0-6 PRE-HAUL MAINTENANCE

This project includes, but is not limited to the following pre-haul maintenance requirements:

<u>Road</u>	<u>Stations</u>	<u>Requirements</u>
H3900	0+00 to 1+00	Brushing, grading, compaction, and acquisition and placement of 1 ½" minus crushed rock.
	1+00 to 16+90	Brushing, grading and compaction.
	16+90 to 22+35	Brushing, grading, compaction, acquisition and placement of 1 ½" minus crushed rock.
	22+35 to 58+70	Brushing, grading and compaction.
H3910	0+00 to 14+20	Brushing, grading and compaction.

SECTION 1 – GENERAL

1-1 ROAD PLAN CHANGES

If the Purchaser desires a change from this road plan including, but not limited to, relocation, extension, change in design, or adding roads; a revised road plan must be submitted in writing to the Contract Administrator for consideration. Before work begins, Purchaser shall obtain approval from the State for any submitted plan that changes the scope of work or environmental condition from the original road plan.

1-2 UNFORESEEN CONDITIONS

Quantities established in this road plan are minimum acceptable values. Additional quantities required by the state due to unforeseen conditions, or Purchaser's choice of construction season or techniques will be at the Purchaser's expense. Unforeseen conditions include, but are not limited to, solid subsurface rock, subsurface springs, saturated ground, and unstable soils.

1-3 ROAD DIMENSIONS

Purchaser shall perform road work in accordance with the dimensions shown on the TYPICAL SECTION SHEET and the specifications within this road plan, unless controlled by construction stakes.

1-4 ROAD TOLERANCES

Purchaser shall perform road work within the tolerances listed below. The tolerance class for each road is listed on the TYPICAL SECTION SHEET.

<u>Tolerance Class</u>	<u>A</u>	<u>B</u>	<u>C</u>
Road and Subgrade Width (feet)	+1.5	+1.5	+2.0
Subgrade Elevation (feet +/-)	0.5	1.0	2.0
Centerline alignment (feet lt./rt.)	1.0	1.5	3.0

1-6 ORDER OF PRECEDENCE

Any conflict or inconsistency in the road plan will be resolved by giving the documents precedence in the following order:

1. Addenda.
2. Designs or Plans. On designs and plans, figured dimensions shall take precedence over scaled dimensions.
3. Road Plan Clauses.
4. Typical Section Sheet.
5. Standard Lists.
6. Standard Details.
7. Road Plan maps.

In case of any ambiguity or dispute over interpreting the road plan, the Contract Administrator’s or designee’s decision will be final.

1-8 REPAIR OR REPLACEMENT OF DAMAGED MATERIALS

Purchaser shall repair or replace all materials, roadway infrastructure, and road components damaged during road work or operation activities. The Contract Administrator will direct repairs and replacements. Repairs to structural materials must be made in accordance with the manufacturer’s recommendation and may not begin without written approval from the Contract Administrator.

1-9 DAMAGED METALLIC COATING

Any cut ends, or damaged galvanized or aluminized coating on existing or new bridge components, culverts, downspouts, and flumes must be cleaned and treated with a minimum of two coats of zinc rich paint or cold galvanizing compound.

1-15 ROAD MARKING

Purchaser shall perform road work in accordance with the state’s marked location. All road work is marked as follows:

- 4’ lathe with orange flagging for construction and reconstruction.
- Construction staked with 2’ stake at top of cut and top of cut reference points.

1-16 CONSTRUCTION STAKES SET BY STATE

Purchaser shall perform work on the following road in accordance with the construction stakes set in the field for grade and alignment. Reconstruction of existing road grades must conform to the original location except where construction staked or designed.

<u>Road</u>	<u>Stations</u>	<u>Type</u>
H3911	2+85 to 4+06	Slope Stake
H3911	5+75 to 7+33	Slope Stake

1-18 REFERENCE POINT DAMAGE

Purchaser shall reset reference points (RPs) that were moved or damaged at any time during construction to their original locations. Excavation and embankment may not proceed on road segments controlled by said RPs until Purchaser resets all moved or damaged RPs.

1-20 COMPLETE BY DATE

Purchaser shall complete reconstruction, and pre-haul maintenance before the start of timber haul.

1-21 HAUL APPROVAL

Purchaser shall not use roads under this road plan for any hauling without written approval from the Contract Administrator.

1-22 WORK NOTIFICATIONS

On all roads, the Purchaser shall notify the Contract Administrator a minimum of 7 calendar days before work begins.

1-23 ROAD WORK PHASE APPROVAL

Purchaser shall obtain written approval from the Contract Administrator upon completion of each of the following phases of road work:

- Subgrade construction
- Subgrade compaction
- Rock application
- Rock compaction

1-25 ACTIVITY TIMING RESTRICTION

Required roadwork activities are not allowed during the closure period, November 1st to April 30th, unless authorized in writing by the Contract Administrator.

1-26 OPERATING DURING CLOSURE PERIOD

If permission is granted to operate during a closure period in Contract Clause H-130, Purchaser shall provide a maintenance plan to include further protection of state resources. Purchaser shall obtain written approval from the Contract Administrator for the maintenance plan and shall put preventative measures in place before operating during the closure period.

1-29 SEDIMENT RESTRICTION

Purchaser shall not allow silt-bearing runoff to enter any streams.

1-30 CLOSURE TO PREVENT DAMAGE

In accordance with Contract Clause G-220 STATE SUSPENDS OPERATION, the Contract Administrator will suspend road work or hauling right-of-way timber, forest products, or rock under the following conditions:

- Wheel track rutting exceeds 4 inches on pit run roads.
- Wheel track rutting exceeds 6 inches on native surface roads.
- Weather is such that satisfactory results cannot be obtained in an area of operations.
- When, in the opinion of the Contract Administrator excessive road damage or rutting may occur.

Operations must stop unless authority to continue working or hauling is granted in writing by the Contract Administrator. If surface or base stability problems persist, Purchaser shall cease operations, or perform corrective maintenance or repairs, subject to specifications within this road plan. Before and during any suspension, Purchaser shall protect the work from damage or deterioration.

1-33 SNOW PLOWING RESTRICTION

On all roads, snowplowing will only be allowed after the execution of a SNOW PLOWING AGREEMENT, which is available from the Contract Administrator upon request. If damage occurs while plowing, further permission to plow may be revoked by the Contract Administrator.

1-40 ROAD APPROACHES TO COUNTY ROADS AND STATE HIGHWAYS

Purchaser shall immediately remove any mud, dirt, rock, or other material tracked or spilled on to county roads and state highways.

If additional damage to the surface, signs, guardrails, etc. occurs then the damage will be repaired, at the Purchaser's expense, as directed by the Contract Administrator when authorized by the county.

SECTION 2 – MAINTENANCE

2-1 GENERAL ROAD MAINTENANCE

Purchaser shall maintain all roads used under this contract in accordance with the FOREST ACCESS ROAD MAINTENANCE SPECIFICATIONS for the entire term of this contract. Maintenance is required even during periods of inactivity.

2-2 ROAD MAINTENANCE – PURCHASER MAINTENANCE

Purchaser shall perform maintenance on roads listed in Contract Clause C-050 PURCHASER ROAD MAINTENANCE AND REPAIR in accordance with FOREST ACCESS ROAD MAINTENANCE SPECIFICATIONS.

2-4 PASSAGE OF LIGHT VEHICLES

Purchaser shall maintain all roads in a condition that will allow the passage of light administrative vehicles.

SECTION 3 – CLEARING, GRUBBING, AND DISPOSAL

3-1 BRUSHING

On the following roads, Purchaser shall cut vegetative material up to 3 inches in diameter, including limbs, as shown on the BRUSHING DETAIL. Brushing must be achieved by mechanical cutting of brush, trees, and branches. Root systems and stumps of cut vegetation may not be disturbed unless directed by the Contract Administrator. Purchaser shall remove brushing debris from the road surface, ditchlines, and culvert inlets and outlets.

<u>Road</u>	<u>Stations</u>
H3900	0+00 to 58+70
H3910	0+00 to 14+20

3-5 CLEARING

Purchaser shall fall all vegetative material larger than 2 inches DBH or over 5 feet high between the marked right-of-way boundaries and within waste and debris areas, or if not marked in the field, between the clearing limits specified on the TYPICAL SECTION SHEET. Clearing must be completed before starting excavation and embankment.

3-10 GRUBBING

Purchaser shall remove all stumps between the grubbing limits specified on the TYPICAL SECTION SHEET and within waste and debris areas. Purchaser shall also remove stumps with undercut roots outside the grubbing limits.

3-20 ORGANIC DEBRIS DEFINITION

Organic debris is defined as all vegetative material not eligible for removal by Contract Clause G-010 PRODUCTS SOLD AND SALE AREA or G-011 RIGHT TO REMOVE FOREST PRODUCTS AND CONTRACT AREA, that is larger than one cubic foot in volume within the clearing limits as shown on the TYPICAL SECTION SHEET.

3-21 DISPOSAL COMPLETION

Purchaser shall remove organic debris from the road surface, ditchlines, and culvert inlets and outlets. Purchaser shall complete all disposal of organic debris, except burning, before start of timber haul.

3-23 PROHIBITED DISPOSAL AREAS

Purchaser shall not place organic debris in the following areas:

- Within 50 feet of a cross drain culvert.
- Within 100 feet of a live stream, or wetland.
- On road subgrades, or excavation and embankment slopes.
- On slopes greater than 40%.
- On locations where brush can fall into the ditch or onto the road surface.
- Against standing timber.

3-24 BURYING ORGANIC DEBRIS RESTRICTED

Purchaser shall not bury organic debris unless otherwise stated in this plan.

3-25 SCATTERING ORGANIC DEBRIS

On the following roads, Purchaser shall scatter organic debris outside of the clearing limits in natural openings on both sides of the road. Where natural openings are unavailable or restrictive, alternate debris disposal methods are subject to the written approval of the Contract Administrator.

<u>Road</u>	<u>Stations</u>
H3900	0+00 to 58+70
H3910	0+00 to 14+20

SECTION 4 – EXCAVATION

4-2 PIONEERING

Pioneering may not extend past construction that will be completed during the current construction season. Pioneering may not extend more than 1000 feet beyond completed construction unless approved in writing by the Contract Administrator. In addition, the following actions must be taken as pioneering progresses:

- Drainage must be provided on all uncompleted construction.
- Road pioneering operations may not undercut the final cut slope or restrict drainage.

4-3 ROAD GRADE AND ALIGNMENT STANDARDS

Purchaser shall follow these standards for road grade and alignment except as designed:

- Grade and alignment must have smooth continuity, without abrupt changes in direction.
- Maximum grades may not exceed 18 percent favorable and 12 percent adverse.
- Minimum curve radius is 60 feet at centerline.
- Maximum grade change for sag vertical curves is 5% in 100 feet.
- Maximum grade change for crest vertical curves is 4% in 100 feet.

4-5 CUT SLOPE RATIO

Purchaser shall construct excavation slopes no steeper than shown on the following table:

<u>Material Type</u>	<u>Excavation Slope Ratio</u>	<u>Excavation Slope Percent</u>
Common Earth (on side slopes up to 55%)	1:1	100
Common Earth (56% to 70% side slopes)	¾:1	133
Common Earth (on slopes over 70%)	½:1	200
Fractured or loose rock	½:1	200
Hardpan or solid rock	¼:1	400

4-6 EMBANKMENT SLOPE RATIO

Purchaser shall construct embankment slopes no steeper than shown on the following table:

<u>Material Type</u>	<u>Embankment Slope Ratio</u>	<u>Embankment Slope Percent</u>
Sandy Soils	2:1	50
Common Earth and Rounded Gravel	1½:1	67
Angular Rock	1¼:1	80

4-7 SHAPING CUT AND FILL SLOPE

Purchaser shall construct excavation and embankment slopes to a uniform line and left rough for easier revegetation.

4-8 CURVE WIDENING

The minimum widening placed on the inside of curves is:

- 6 feet for curves of 50 to 79 feet radius.
- 4 feet for curves of 80 to 100 feet radius.

4-9 EMBANKMENT WIDENING

The minimum embankment widening is:

- 2 feet for embankment heights at centerline of 2 to 6 feet.
- 4 feet for embankment heights at centerline of greater than 6 feet.

4-10 WIDEN THE EXISTING SUBGRADE

On the following roads, Purchaser shall widen the subgrade and fill slopes to the dimensions shown on the TYPICAL SECTION SHEET. If necessary, Purchaser shall reconstruct excavation slopes to provide sufficient width for the road surface and any ditches.

<u>Road</u>	<u>Stations</u>
H3910	14+20 to 30+85
H3911	0+00 to 23+50

4-35 WASTE MATERIAL DEFINITION

Waste material is defined as all dirt, rock, mud, or related material that is extraneous or unsuitable for construction material. Waste material, as used in Section 4 EXCAVATION, is not organic debris.

4-38 PROHIBITED WASTE DISPOSAL AREAS

Purchaser shall not deposit waste material in the following areas:

- Within 50 feet of a cross drain culvert.
- Within 100 feet of a live stream or wetland.
- On side slopes steeper than 40%.
- In locations that interfere with the construction of the road prism.
- In locations that impede drainage.
- Against standing timber.

4-55 ROAD SHAPING

Purchaser shall shape the subgrade and surface as shown on the TYPICAL SECTION SHEET. The subgrade and surface shape must ensure runoff in an even, un-concentrated manner, and must be uniform, firm, and rut-free.

4-56 DRY WEATHER SHAPING

At any time of the year, the Contract Administrator may require the application of water to facilitate shaping activities. The method of water application is subject to written approval by the Contract Administrator.

4-60 FILL COMPACTION

Purchaser shall compact all embankment and waste material in accordance with the COMPACTION LIST by routing excavation equipment over the entire width of each lift. Waste material may be placed by end-dumping or sidecasting until sufficiently wide enough to support the equipment.

4-62 DRY WEATHER COMPACTION

At any time of the year, the Contract Administrator may require the application of water to facilitate compaction activities. The method of water application is subject to written approval by the Contract Administrator.

SECTION 5 – DRAINAGE

5-33 NATIVE SURFACE ROADS

If overwintered, native surface roads must be waterbarred by November 1. Purchaser shall construct waterbars according to the attached DRIVABLE WATERBAR DETAIL at a maximum spacing that will produce a vertical distance of no more than 10 feet between waterbars or between natural drainage paths, and with a maximum spacing of 300 feet.

SECTION 6 – ROCK

6-5 ROCK FROM COMMERCIAL SOURCE

Rock used in accordance with the quantities on the ROCK LIST shall be obtained from a commercial source at the Purchaser's expense. Rock sources are subject to written approval by the Contract Administrator before its use.

6-29 1 ½-INCH MINUS CRUSHED ROCK

% Passing 1 ½" square sieve	100%
% Passing 1" square sieve	70 - 90%
% Passing 5/8" square sieve	50 - 80%
% Passing U.S. #4 sieve	30 - 50%
% Passing U.S. #40 sieve	3 - 18%
% Passing U.S. #200 sieve	7.5% maximum

The portion of aggregate retained on the No. 4 sieve may not contain more than 0.2 percent organic debris and trash. All percentages are by weight.

6-55 ROCK APPLICATION MEASURED BY COMPACTED DEPTH

Measurement of specified rock depths, are defined as the compacted depths using the compaction methods required in this road plan. Estimated quantities specified in the ROCK LIST 1 ½" MINUS CRUSHED are compacted yards. Purchaser shall apply adequate amounts of rock to meet the specified rock depths. Specified rock depths are minimum requirements and are not subject to reduction.

6-70 APPROVAL BEFORE ROCK APPLICATION

Purchaser shall obtain written approval from the Contract Administrator for subgrade before rock application.

6-71 ROCK APPLICATION

Purchaser shall apply rock in accordance with the specifications and quantities shown on the ROCK LIST – 1 ½" MINUS CRUSHED ROCK must be spread, shaped, and compacted full width concurrent with rock hauling operations. Road surfaces must be compacted in accordance with the COMPACTION LIST by routing excavation equipment over the entire width.

6-76 DRY WEATHER ROCK COMPACTION

The Contract Administrator may require the application of water to facilitate compaction of rock surfacing. The method of water application is subject to approval by the Contract Administrator.

SECTION 7 – STRUCTURES

7-1 SIGN INSTALLATION

Purchaser shall install and maintain the following road sign. Signs must be installed a minimum of 7 days before log haul commences.

<u>Road</u>	<u>Station</u>	<u>Comment</u>	<u>Sign</u>
Canyon Road	MP 13.4	South of Canyon Road and H3900 junction	Log Trucks
Canyon Road	MP 13.6	North of Canyon Road and H3900 junction	Log Trucks

7-70 GATE CLOSURE

On the following road, Purchaser shall keep gates closed and locked except during periods of haul. All gates must be closed at termination of use.

<u>Road</u>	<u>Station</u>	<u>Comment</u>
H3900	0+30	Four-wire cattle gate

SECTION 9 – POST-HAUL ROAD WORK

9-5 POST-HAUL MAINTENANCE

Purchaser shall perform post-haul maintenance in accordance with the FOREST ACCESS ROAD MAINTENANCE SPECIFICATIONS.

<u>Road</u>	<u>Stations</u>
H3900	0+00 to 58+70
H3910	0+00 to 30+85
H3911	0+00 to 23+50

9-6 CLEANING CULVERTS

On the following roads, Purchaser shall clean the inlets and outlets of all culverts.

<u>Road</u>	<u>Station</u>
H3900	17+30
H3910	4+15

9-10 LANDING DRAINAGE

Purchaser shall provide for positive drainage of all landing surfaces.

TYPICAL SECTION SHEET

OUTSLOPED ROAD CROSS-SECTION
(not to scale)

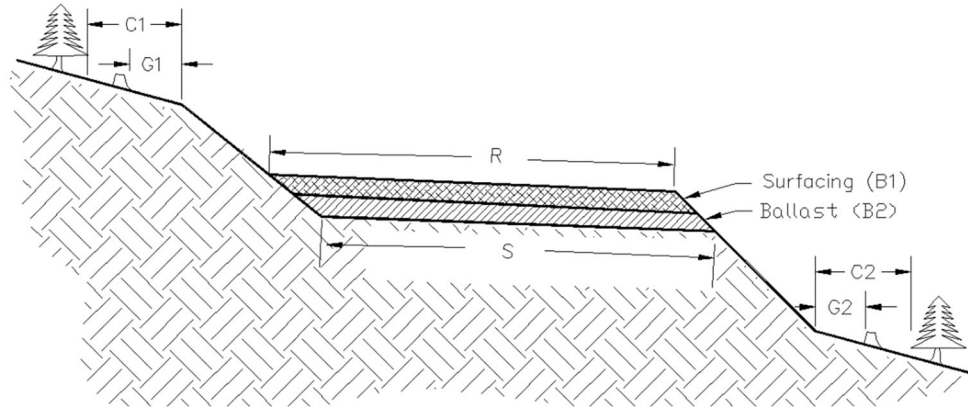

NO
RECO
EDGE
CLEA
RIGHT
FLAG
RIGH

ROAD	CONSTRUCTION/ RECONSTRUCTION/ PRE-HAUL	FROM STATION	TO STATION	TOL. CLASS	SUBGRADE WIDTH S	CROWN INCHES @ CENTERLINE	OUTSLOPE INCHES IN 10 FEET	ROAD WIDTH R	DITCH WIDTH DEPTH		GRUBBING LIMITS		CLEARING LIMITS	
									W	D	G1	G2	C1	C2
H3900	Pre-haul Maintenance	0+00	58+70		12'		4"	14'	NA	NA	NA	NA	See Note	See Note
H3910	Pre-haul Maintenance	0+00	14+20		12'		4"	12'	NA	NA	NA	NA	See Note	See Note
	Reconstruction	14+20	30+85	C	12'		4"	12'	NA	NA	See Note	See Note	See Note	See Note
H3911	Reconstruction	0+00	23+50	C	12'		4"	12'	NA	NA	See Note	See Note	See Note	See Note

ROCK LIST – 1½” MINUS CRUSHED

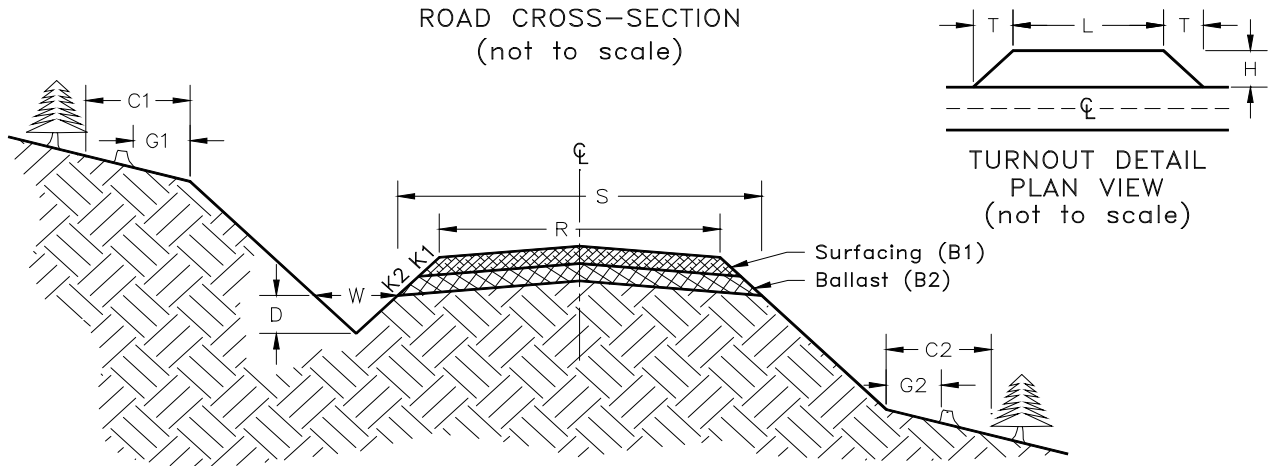

Road Number	From Station	To Station	Rock Slope	Compacted Rock Depth	C.Y./ Station	# of Stations	C.Y. Subtotal	Rock Source
H3900	0+00	1+00	1 ½ :1	3"	14	1.00	14	Commercial
H3900	16+90	22+35	1 ½ :1	3"	14	5.45	76	Commercial

TOTAL 90 Cubic Yards

COMPACTION LIST

Road	From Station	To Station	Type	Equipment Type	Equipment Weight (lbs)	Minimum Number of Passes	Maximum Operating Speed (mph)
H3900	0+00	58+70	Subgrade Rock	Vibratory Smooth Drum	16000	3	3
H3910	0+00	30+85	Subgrade	Vibratory Smooth Drum	16000	3	3
H3911	0+00	23+50	Subgrade	Vibratory Smooth Drum	16000	3	3

RIGHT-OF-WAY SPECIFICATION SHEET

Based on a 12' road width. All clearing distances are measured horizontally from the centerline of the road. All ditches are 1' deep. Ditched roads are crowned 4" at the centerline. Roads with no ditch are outsloped 4" in 10'.

CROWNED ROAD WITH DITCH RIGHT

<u>Sideslope</u>	<u>Clearing Left</u>	<u>Clearing Right</u>
0-10%	16'	14'
10-20%	17'	15'
20-30%	19'	17'
30-40%	22'	18'
40-50%	27'	22'

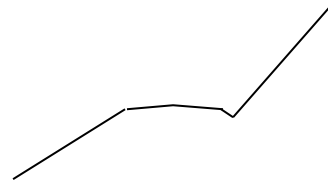

OUTSLOPE LEFT ROAD

<u>Sideslope</u>	<u>Clearing Left</u>	<u>Clearing Right</u>
0-10%	16'	11'
10-20%	17'	12'
20-30%	19'	13'
30-40%	22'	15'
40-50%	27'	17'

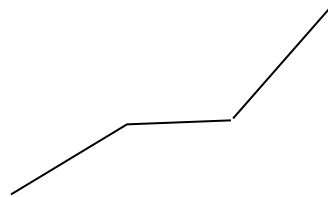

CROWNED ROAD WITH DITCH LEFT

<u>Sideslope</u>	<u>Clearing Left</u>	<u>Clearing Right</u>
0-10%	14'	16'
10-20%	15'	17'
20-30%	17'	19'
30-40%	18'	22'
40-50%	22'	27'

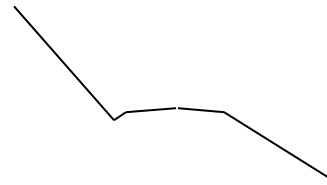

OUTSLOPE RIGHT ROAD

<u>Sideslope</u>	<u>Clearing Left</u>	<u>Clearing Right</u>
0-10%	11'	16'
10-20%	12'	17'
20-30%	13'	19'
30-40%	15'	22'
40-50%	17'	27'

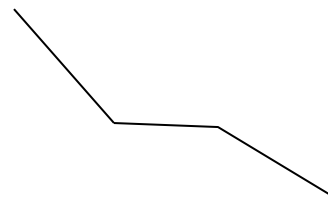

DRIVABLE WATER BAR DETAIL

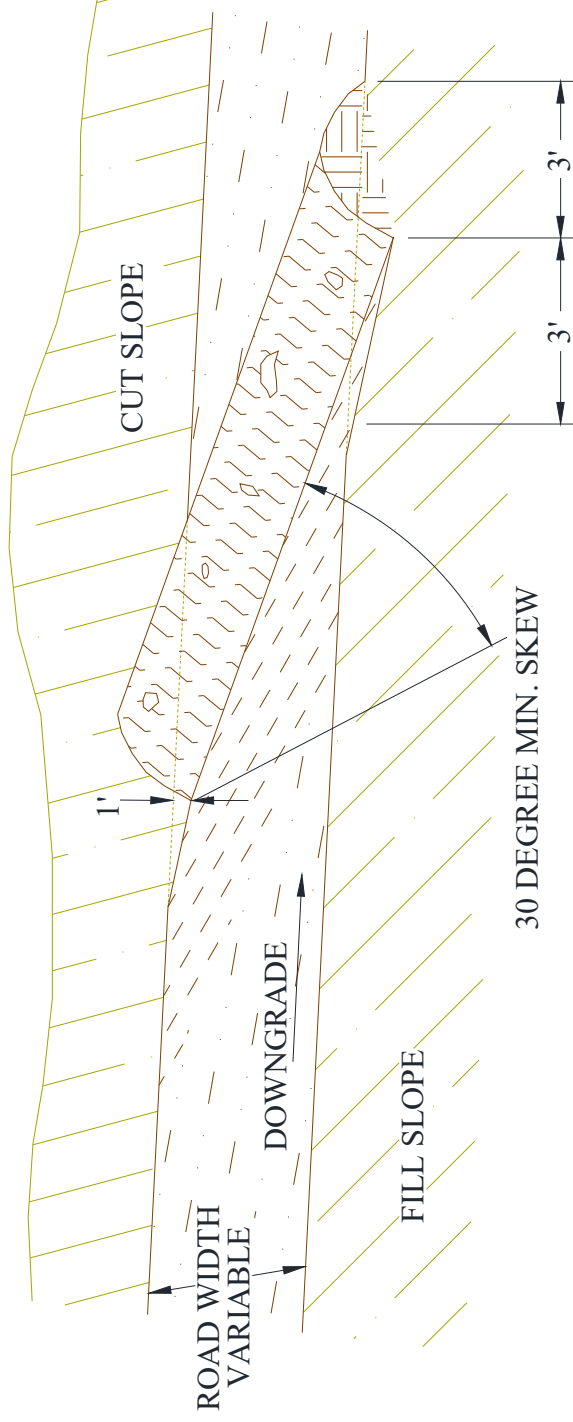

NOTES:

1. ALL WATER BARS SHALL BEGIN AT THE INTERSECTION OF THE ROADBED AND CUT SLOPE AND RUN ACROSS THE ENTIRE WIDTH OF THE ROADBED.
2. ALL WATER BARS SHALL HAVE FREE FLOWING OUTLETS.

BRUSHING DETAIL

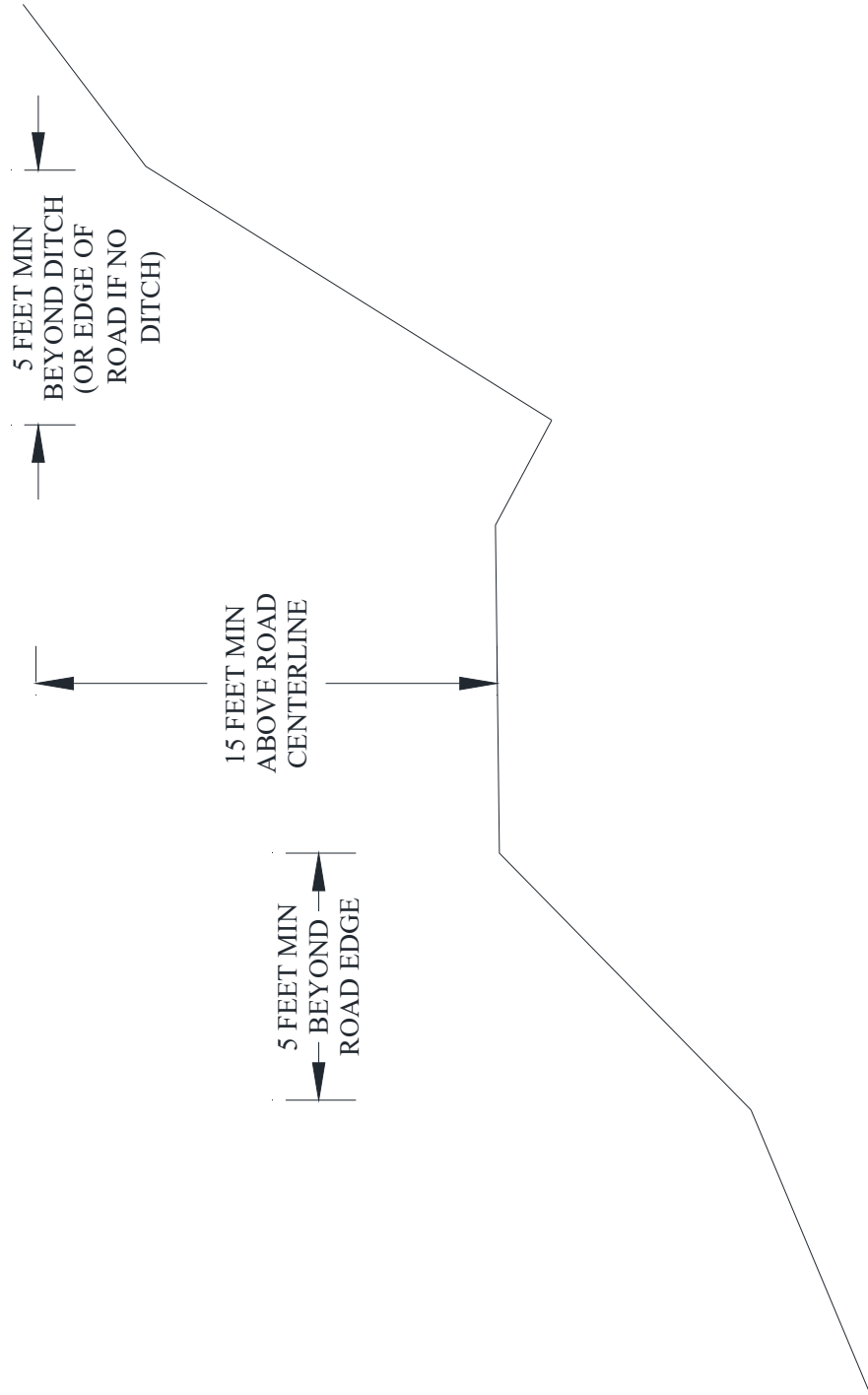

FOREST ACCESS ROAD MAINTENANCE SPECIFICATIONS

Cuts and Fills

- Maintain slope lines to a stable gradient compatible with the cut slope/fill slope ratios. Remove slides up to 50 cubic yards in volume from ditches and the roadway. Repair fill-failures, in accordance with Clause 4-6 EMBANKMENT SLOPE RATIO, with selected material or material approved by the Contract Administrator. Remove overhanging material from the top of cut slopes.
- Waste material from slides or other sources shall be placed and compacted in stable locations identified in the road plan or approved by the Contract Administrator, so that sediment will not deliver to any streams or wetlands.
- Slide material and debris shall not be mixed into the road surface materials, unless approved by the Contract Administrator.

Surface

- Grade the road surface, turnouts, and shoulders to the original shape on the TYPICAL SECTION SHEET to provide a smooth, rut-free traveled surface and maintain surface water runoff in an even, unconcentrated manner.
- Blading shall not undercut the backslope or cut into geotextile fabric on the road.
- If required by the Contract Administrator, water shall be applied as necessary to control dust and retain fine surface rock.
- Surface material shall not be bladed off the roadway. Replace surface material when lost or worn away, or as directed by the Contract Administrator.
- Remove shoulder berms, created by grading, to facilitate drainage, except as marked or directed by the Contract Administrator.
- For roads with geotextile fabric: spread surface aggregate to fill in soft spots and wheel ruts (barrel spread) to prevent damage to the geotextile fabric.

Drainage

- Prevent silt bearing road surface and ditch runoff from delivering sediment to any streams or wetlands.
- Maintain rolling dips and drivable waterbars as needed to keep them functioning as intended.
- Maintain headwalls to the road shoulder level with material that will resist erosion.
- Maintain energy dissipaters at culvert outlets with non-erodible material or rock.
- Keep ditches, culverts, and other drainage structures clear of obstructions and functioning as intended.
- Inspect and clean culverts at least monthly, with additional inspections during storms and periods of high runoff. This shall be done even during periods of inactivity.

Preventative Maintenance

- Perform preventative maintenance work to safeguard against storm damage, such as blading to ensure correct runoff, ditch, and culvert cleaning, and waterbar maintenance.

Termination of Use or End of Season

- At the conclusion of logging operations, ensure all conditions of these specifications have been met.

Debris

- Remove fallen timber, limbs, and stumps from the slopes, roadway, ditchlines, and culvert inlets.

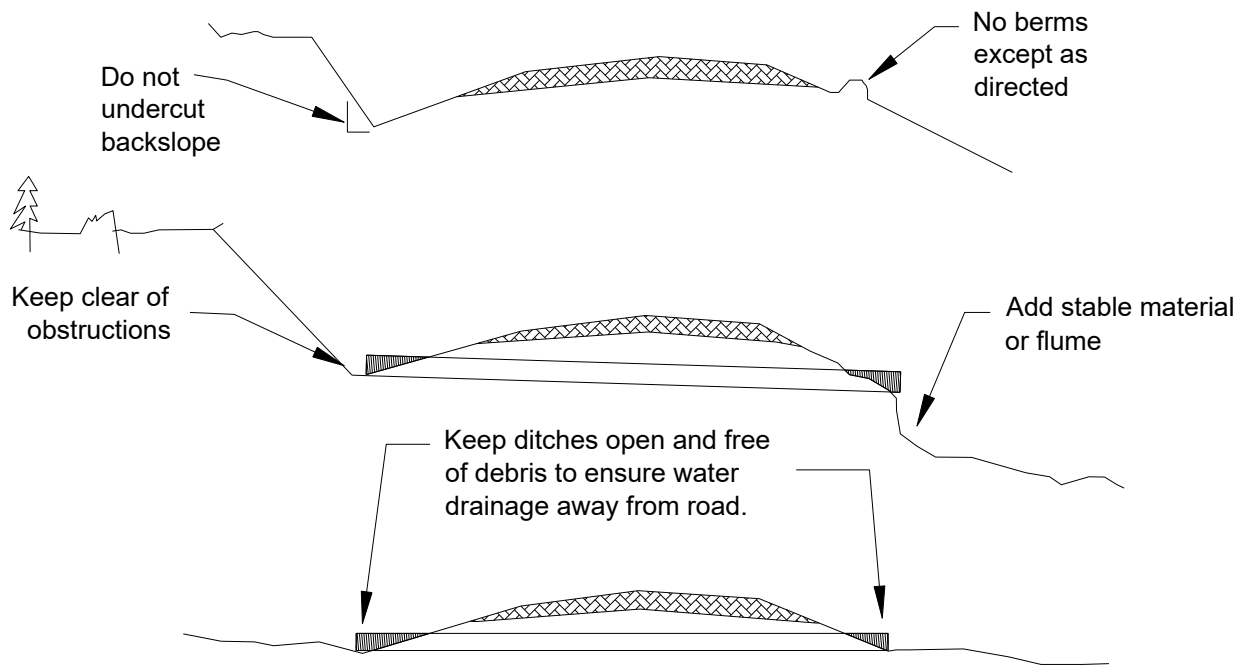

ROAD PLAN MAP

SALE NAME: LIBERTY
AGREEMENT#: 30-106233
TOWNSHIP: T4R12E
TRUST: State Forest Transfer (1)

REGION: Southeast Region
COUNTY: Klickitat
ELEVATION RGE: 2280-2400

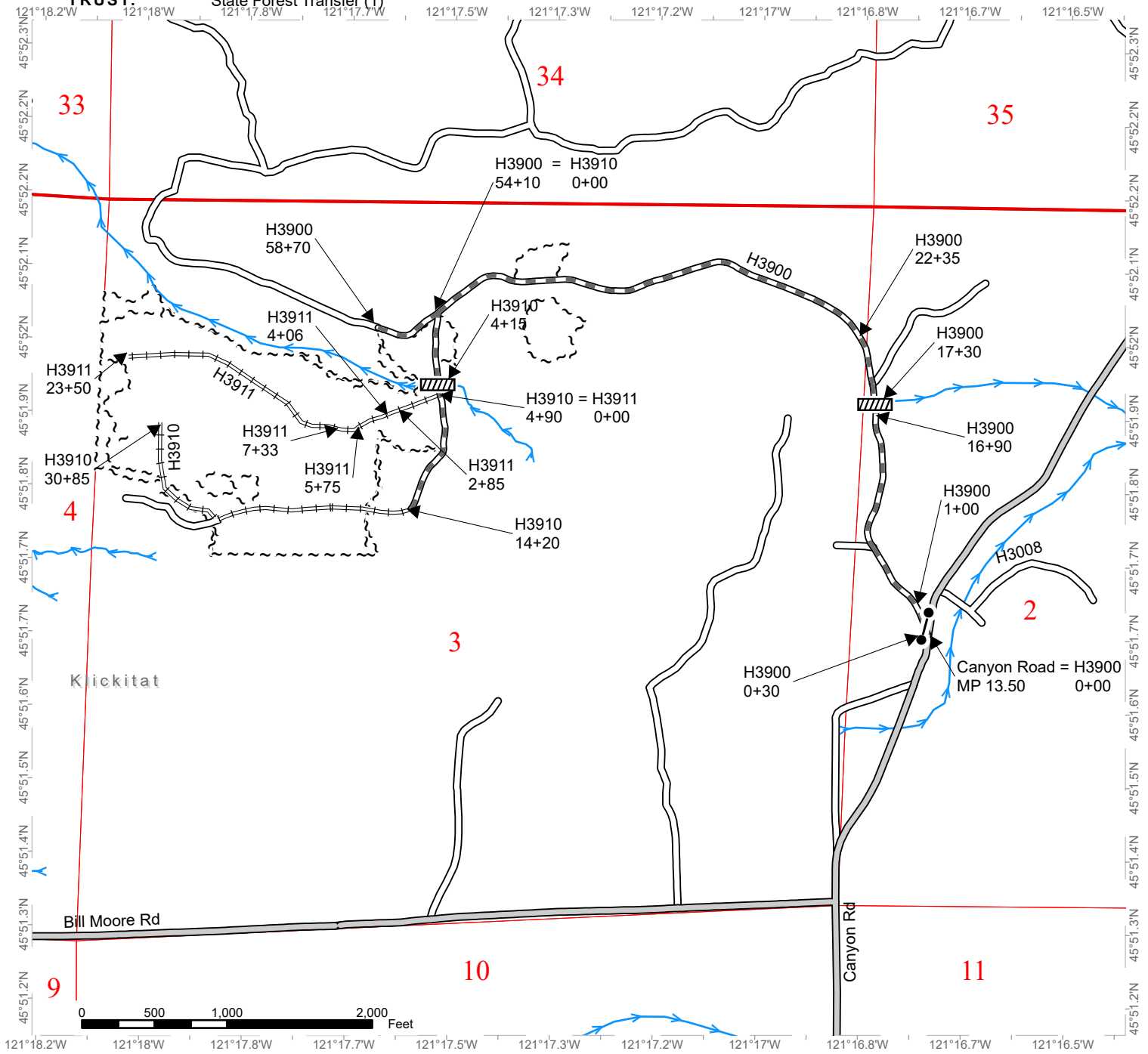

- County Road
- Existing Roads
- Required Pre-Haul Maintenance
- Required Reconstruction
- Streams
- Sale Boundary Tags
- Culvert
- Gate



SUMMARY - Road Development Costs

REGION: Southeast

UNIT: Klickitat

SALE/PROJECT NAME: Liberty CONTRACT #: 30-106233

ROAD NUMBERS:	H3910, H3911	H3900, H3910
ROAD STANDARD:	Reconstruction	Maintenance
NUMBER OF STATIONS:	40.15	72.90
CLEARING & GRUBBING:	\$4,898.30	
EXCAVATION AND FILL:	\$6,022.50	-
MISC. MAINTENANCE:		\$3,236.76
ROAD ROCK:		\$3,294.14
MOBILIZATION:	\$1,029.94	\$1,870.06
TOTAL COSTS:	\$11,950.74	\$8,400.96
COST PER STATION:	\$297.65	\$115.24
FINAL MAINTENANCE:	\$1,315.28	
POST-HAUL MOBILIZATION:	\$1,050.00	
CONTRACTOR OVERHEAD:	\$3,407.55	
TOTAL (All Roads) =		\$26,124.53
SALE VOLUME MBF =		1,016
TOTAL \$/MBF =		\$25.71

Compiled by: Tara Baker

Date: 1/2/2023