

TFW Monitoring Program

METHOD MANUAL

for the

**SALMONID SPAWNING GRAVEL
COMPOSITION SURVEY**

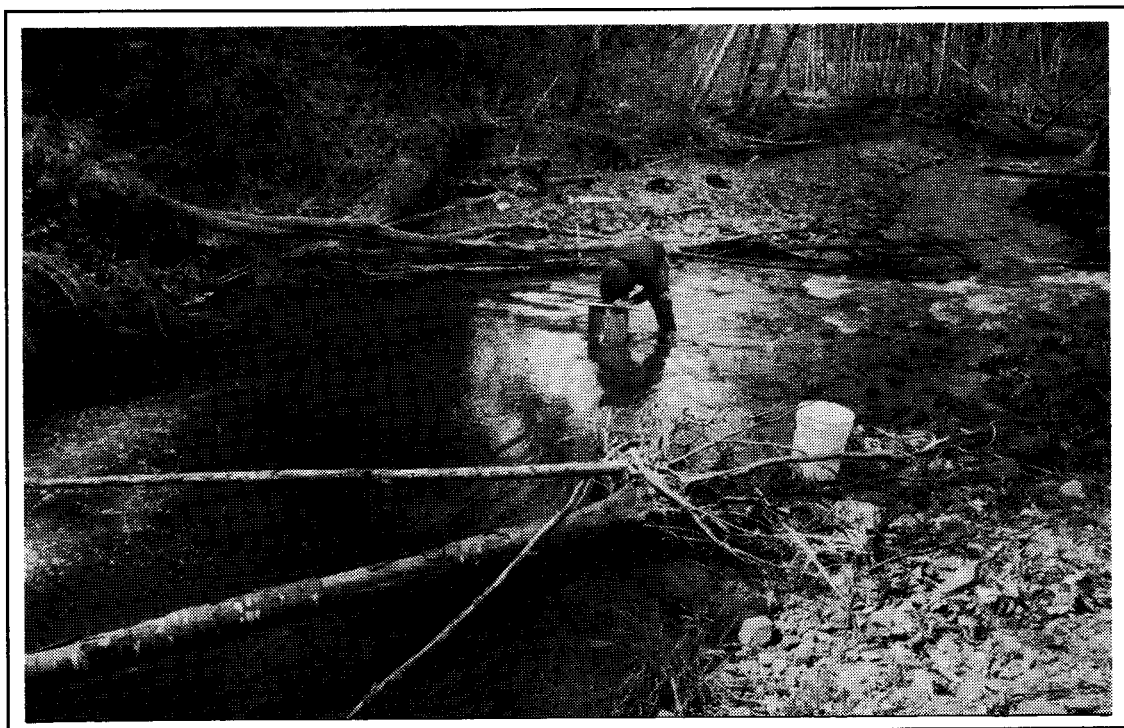

by:

Dave Schuett-Hames

Robert Conrad

Allen Pleus

Michael McHenry



March 1999





Schuett-Hames, D., R. Conrad, A. Pleus, and M. McHenry. 1999. TFW Monitoring Program method manual for the salmonid spawning gravel composition survey. Prepared for the Washington State Dept. of Natural Resources under the Timber, Fish, and Wildlife Agreement. TFW-AM9-99-001. DNR #101. March.

Abstract

The Timber Fish Wildlife (TFW) Monitoring Program method manual for the Salmonid Spawning Gravel Composition (SG Comp) Survey provides a standard method for the assessment and monitoring of salmonid spawning gravel composition. The method is divided into sample inventory, collection, and processing sections. The inventory process ensures that samples from either riffle crests or gravel patch features are representative of spawning gravel composition on a stream segment scale. The McNeil sampler is used to collect samples on inventoried sites. There are two options for processing samples through a standard set of sieves. The relatively quicker volumetric method measures the volume (milliliters), and the gravimetric method measures the weight (grams), of sample particles by size class. TFW data management services provides basic data analysis for spawning gravel samples such as calculating the percentage of particles less than 0.85 millimeters ("fine sediments" - volumetric equivalent) and the geometric mean diameter (gravimetric equivalent).

The introduction section describes the purpose of the SG Comp Survey, reviews scientific background information, and describes the services provided by the TFW Monitoring Program. Following the introduction, sections are presented in order of survey application including: study design, sample inventory, sample collection, sample processing, survey documentation, data management, and references. An extensive appendix is also provided that includes an equipment and resource contact list, copy masters of field forms, examples of completed field forms, standard field and vehicle gear checklist, sample bucket data tracking slips, database management examples, and a random number table.

TFW Monitoring Program
Northwest Indian Fisheries Commission
6730 Martin Way E.
Olympia, WA 98516

Ph: (360)438-1180
Fax: (360)753-8659

Internet:
<http://www.nwifc.wa.gov>

Washington Dept. of Natural Resources
Forest Practices Division: CMER Documents
P.O. Box 47014
Olympia, WA 98504-7014

Ph: (360)902-1400

The Authors

Dave Schuett-Hames is the TFW Monitoring Program Coordinator/Biologist at the Northwest Indian Fisheries Commission. He received a B.S. degree in biology (1976) and an M.E.S. (1996) from The Evergreen State College. He worked for 12 years as a fish habitat biologist for the Lummi and the Squaxin Island Tribes. He joined the program in 1991.

Robert Conrad is the NWIFC Quantitative Services Division Manger. He received a B.S. degree in Fisheries (1978) and an M.S. degree in Fisheries (1983) from the University of Washington. He began working for the NWIFC in 1989.

Allen E. Pleus is the Lead Training and Quality Assurance Biologist for the TFW Monitoring Program at the Northwest Indian Fisheries Commission. He received a B.A. degree in communications (1985) and an M.E.S. (Master's degree in Environmental Studies, 1995) from The Evergreen State College. He began working for the program in 1991.

Michael McHenry is TFW Biologist for the Lower Elwha S'Klallam Tribe, Fisheries Department, 51 Hatchery Road, Port Angeles, WA 98362.

Manual cover, method illustrations, and layout by Allen Pleus

Acknowledgements

The development of this document was funded by the Timber-Fish-Wildlife (TFW) Cooperative Monitoring, Evaluation, and Research (CMER) committee through a grant from the State of Washington. Special thanks to Phil Peterson for his help in the original development of the methods and for continued assistance as a technical adviser. Thanks to Jeff Cederholm for technical assistance. TFW Monitoring Program (TFW-MP) staff members Amy Morgan and Devin Smith contributed a great many hours collecting information, reviewing and editing drafts, and helping with production. Northwest Indian Fisheries Commission (NWIFC) staff members including Tony Meyer, Sheila McCloud, Debbie Preston, Lois Allen, and Lea Miller have provided valuable proofing, layout, and production assistance. Finally, thanks to the TFW Monitoring Advisory Group members including Randy McIntosh and Jeff Light (Co-chairs) for their support and guidance.

Copying of the Method Manual

All TFW Monitoring Program method manuals are public documents. No permission is required to copy any part. The only requirement is that they be properly cited. Copies of the methods manuals are available from the TFW Monitoring Program at the Northwest Indian Fisheries Commission or from the Washington Dept. of Natural Resources.

Contents

1	Introduction	1
1.1	Purpose	1
1.2	Background	2
1.2.1	Salmonid Incubation Life History	2
1.2.2	Effects of Fine Sediment on the Incubation Environment	2
1.2.3	Natural and Management-Related Sources of Fine Sediments	2
1.2.4	Method Development	2
1.3	Cooperator Services	3
2	Study Design	4
2.1	Selection of Monitoring Segments	4
2.1.1	Identify Sampling Segments	4
2.1.2	Identify Logistically Feasible Sampling Areas Within the Segment	4
2.2	Timing of Surveys	6
2.3	Sample Method Options	6
2.4	Sample Processing Options	6
2.5	Survey Modification Options	7
2.6	Pre-Season Training and Quality Assurance Reviews	7
3	Sample Inventory	8
3.1	Pre-Inventory Tasks	8
3.1.1	Inventory Equipment	8
3.1.2	Inventory Materials	8
3.2	Sample Inventory Method	10
3.2.1	Option 1: Riffle Crest Inventory Procedure	10
3.2.2	Option 2: Gravel Patch Inventory Procedure	15
3.3	Post-Inventory Tasks	19
3.3.1	Sample Population Identification	19
3.3.2	Sub-Sample Population Identification	20
4	Sample Collection	22
4.1	Pre-Collection Tasks	22
4.1.1	Collection Equipment	22
4.1.2	Collection Materials	22
4.2	Sample Collection Method	23
4.3	Post-Collection Tasks	30
5	Sample Processing	31
5.1	Option 1: Volumetric Processing Method	31
5.1.1	Pre-Volumetric Sieve Processing Tasks	31
5.1.2	Volumetric Sieve Processing Procedure	32
5.1.3	Pre-Volumetric Measurement Tasks	35
5.1.4	Volumetric Measurement Procedure	35
5.2	Option 2: Gravimetric Processing Method	39
5.2.1	Pre-Gravimetric Processing Tasks	39
5.2.2	Gravimetric Processing Procedure	40
5.2.3	Post-Gravimetric Processing Tasks	40

Contents (cont.)

6 Survey Documentation 41

6.1 Finalizing Field Forms 41

6.2 Error Checking 42

7 Data Management 43

7.1 Data Preparation 43

7.2 Data Processing, Products, and Archiving 43

7.3 Data Analysis 43

7.3.1 Spawning Gravel Composition Segment Report 44

7.3.2 Spawning Gravel Composition Sample Site Report 44

7.3.3 Spawning Gravel Composition Individual Sample Report 44

8 References 46

9 Appendixes 49

Appendix A: Form 6.0, 6.1R, 6.1P, 6.2, and 6.3 Copy Masters

Appendix B: Completed Examples of Forms 6.0, 6.1R, 6.1P, 6.2, and 6.3

Appendix C: Standard Field and Vehicle Gear Checklist Copy Master

Appendix D: Sample Tracking Slip Copy Master

Appendix E: Data Management Examples

Appendix F: Random Number Table

Salmonid Spawning Gravel Composition Survey

1. Introduction



The Timber Fish Wildlife (TFW) Monitoring Program method manual for the Salmonid Spawning Gravel Composition (SG Comp) Survey provides a standard method for the assessment and monitoring of salmonid spawning gravel composition. The method is divided into sample inventory, collection, and processing sections. The inventory process ensures that samples from either riffle crests or gravel patch features are representative of spawning gravel composition on a stream segment scale. The McNeil sampler is used to collect samples on inventoried sites. There are two options for processing samples through a standard set of sieves. The relatively quicker volumetric method measures the volume (milliliters), and the gravimetric method measures the weight (grams), of sample particles by size class. TFW data management services provides basic data analysis for spawning gravel samples such as calculating the percentage of particles less than 0.85 millimeters ("fine sediments" - volumetric equivalent) and the geometric mean diameter (gravimetric equivalent).

This introduction section describes the purpose of the SG Comp Survey, reviews scientific background information, and describes the services provided by the TFW Monitoring Program. Following the introduction, sections are presented in order of survey application including: study design, sample inventory, sample collection, sample processing, survey documentation, data management, and references. An extensive appendix is also provided that includes copy masters of field forms, examples of completed field forms, standard field and vehicle gear checklist, sample bucket data tracking slips, database management examples, and a random number table.

1.1 Purpose

The Timber-Fish-Wildlife Monitoring Program (TFW-MP) provides standard methods for stream monitoring that reliably detect changes and trends in stream channel morphology and characteristics over time. The Salmonid Spawning Gravel Composition (SG Comp) Survey method has been approved by TFW's Cooperative Monitoring, Evaluation and Research Committee (CMER). It is accepted as a standard method for stream monitoring on forest lands in Washington State by tribal governments, state natural resource agencies, timber industries, environmental organizations, and others.

The survey is designed for use on streams where there is no prior data available on variation in gravel composition to guide sample design. For streams with existing data, it may be preferable to develop custom sampling strategies based on segment-specific variation. The information generated using this methodology is suitable for:

- 1) Evaluating the composition and characteristics of spawning gravel;
- 2) Estimating the percentage of fine sediments less than 0.85 mm for Watershed Analysis;
- 3) Comparing spawning gravel composition among stream segments, watersheds and eco-regions; and
- 4) Monitoring trends in spawning gravel composition over time.

The survey does not attempt to document or predict actual survival to emergence, because that objective would require research of an intensity impractical for management purposes. Neither is it oriented towards the requirements of any particular salmonid species, as species may vary within and between stream segments around the state.

1.2 Background

This section provides a review of the scientific literature used as the basis for the SG Comp Survey. Background information includes salmonid incubation life history, effects of fine sediments on the incubation environment, natural and management-related sources of fine sediment, and method development.

1.2.1 Salmonid Incubation Life History

The development of salmonid eggs and alevin typically occurs in the gravel substrate of freshwater rivers and streams. Mature females choose sites where substrate and flow conditions are favorable and deposit their eggs in nests (redds) they excavate in the substrate. After the eggs hatch, the alevins continue to reside within the stream bed gravel, subsisting on nutrients from an external yolk-sac. When the yolk-sac has been absorbed they emerge from the gravel and begin active feeding.

While developing, the eggs and alevin require a stable stream bed and an adequate supply of water to supply oxygen, carry away metabolic waste, and prevent dehydration. Mortality during intra-gravel development is highly variable, depending on hydrologic, geomorphic and biotic conditions. Mortality has been attributed to a variety of causes including disease, predation, suffocation, dehydration, mechanical disturbance and freezing (McNeil, 1969).

1.2.2 Effects of Fine Sediments on the Incubation Environment

Salmonid eggs require an abundant supply of dissolved oxygen to ensure survival to emergence and proper development (Alderdice et al., 1958). Oxygen reaches the eggs through a three-step process involving dissolution of oxygen from the atmosphere into stream water, transport of oxygenated water to the stream bottom, and interchange of oxygenated water from the stream to the pores between gravel in the egg pocket (Vaux, 1962). Fine sediment (fine sand, silt or clay) that lodges in the interstitial spaces between gravel particles reduces permeability and slows the rate of flow through the gravel substrate (McNeil and Ahnell, 1964; Johnson, 1980). Numerous studies (Chapman, 1988, Everest et al., 1987; Iwamoto et al. 1978) have associated high levels

of fine sediments with elevated mortality rates and reduced fitness of surviving fish (Koski, 1975). These effects are due to increased stress and mortality associated with oxygen deprivation (Alderdice et al., 1958), the accumulation of toxic metabolic by-products (Barns and Lam, 1983), and entombment of emerging fry (Chapman, 1988).

1.2.3 Natural and Management-Related Sources of Fine Sediments

Concentrations of fine sediments in stream channels vary in space and time (Adams and Beschta, 1980). The amount of fine sediments present at a particular location depends on the nature and magnitude of erosional processes that produce fine sediments and introduce them to the stream channel, as well as the geomorphic factors that control the transport and storage of sediments, such as stream gradient and hydrology. In addition, spawning salmonids tend to remove fine sediments from the substrate during redd construction, however the persistence of this effect is not well understood (Everest et al. 1987). During the incubation period, fine sediments moving through the stream channel may intrude into the redd. The severity and significance of fine sediment intrusion is related to the size and amounts of transported sediment, and the depth of intrusion (Lisle, 1989).

Fine sediment levels are higher in watersheds where the geology, soils, precipitation or topography create conditions favorable for erosional processes that produce fine sediments (Duncan and Ward, 1985). Fine sediments are typically more abundant where land-use activities such as road-building or land-clearing expose soil to erosion and increase mass wasting (Cederholm et al., 1981; Swanson et al., 1987; Hicks et al., 1991).

1.2.4 Method Development

The McNeil sampler modified with the Koski plunger was selected to collect samples of spawning gravel for analysis as recommended by Peterson et al. (1992). It was chosen for the following reasons: a) it is a reliable sampling device that is simple to operate; b) although bulky, it is relatively portable and requires little auxiliary equipment; and c) it has been used in Washington State for survival to emergence studies that were the basis of the Forest Practices Board cumulative effects

threshold values for spawning gravel fine sediments.

The riffle crest sampling method is based on original research by Tripp and Poulin (1986) and modified through original research and recommendations by a TFW technical advisory committee. Riffle crests were chosen as sampling sites for the following reasons: a) they are utilized by nearly all salmonids for spawning; b) they are distinct geomorphic features that can be identified and located by different observers in a wide variety of streams. The gravel patch sampling method was developed using the riffle crest method as a template. Both sampling methods are designed to eliminate bias associated with using species-specific criteria to identify sampling sites and the effect of run-size with using historic spawning sites.

Parameters used to assess spawning gravel were selected as recommended by Schuett-Hames and Pleus (1996) and applied in the Salmonid Spawning Habitat Availability Survey (Schuett-Hames and Pleus, 1999). Maximum water depth (0.3 meters) and dominant substrate size (8 and <100 millimeters) have been modified due to equipment limitations. The systematic random sampling strategy was developed through statistical examination of four existing large spawning gravel data sets from Washington State to determine variation within and among riffle crests.

The volumetric (wet) method of processing spawning gravel originated with Dr. William McNeil's studies of pink and chum salmon spawning grounds in southeast Alaska in the late 1950's (McNeil and Ahnell, 1960). This method has been used, with refinements, in many additional studies of spawning gravel in Washington State (Koski, 1966 and 1975; Cederholm and Lestelle, 1974; Tagart, 1976).

The gravimetric method of processing spawning gravel samples has its foundation in the engineering (materials testing) and soil sciences. This method has been used occasionally within Washington (McHenry et al., 1994; Peterson, pers. com., 1999). Outside of Washington, fisheries biologists have increasingly used this methodology (Lotspeich and Everest, 1981, Shepard et al., 1984, Platts et al., 1989).

1.3 Cooperator Services

The TFW Monitoring Program provides a comprehensive suite of services to support TFW cooperators. Services include study design assistance, pre-season training through annual workshops and on-site visits, pre-season quality assurance reviews, data entry systems, summary reports of monitoring results, and database/data archiving services. An instructional video has been produced for this survey and is available for loan or purchase through other sources. These services are offered free of charge. To find out more about these services and the TFW Monitoring Program, contact us or visit our link on the NWIFC homepage. The address is:

TFW Monitoring Program
Northwest Indian Fisheries Commission
6730 Martin Way East
Olympia, WA 98516

Ph: (360) 438-1180
Fax: (360) 753-8659

Internet site: <http://www.nwifc.wa.gov>

2. Study Design

Effective monitoring study designs require rigorous planning, documentation, and consistency in methods, method application, and data analysis. This ensures that the monitoring data produced meets the objectives of the project and monitoring plan. A good study design identifies changes in channel characteristics over time due to land management or natural disturbances by establishing either a sound baseline or following the original study design. Poor study designs detect changes that are the result of differences in crew method application or changes in where the samples were collected on the stream.

The following TFW Monitoring Program surveys provide the best monitoring framework for documentation and analysis of SG Comp data. These methods are required or highly recommended prior to conducting the SG Comp Survey:

- ◆ Stream Segment Identification (required)
- ◆ Reference Point Survey (recommended)

Segment data documented on Form 1 and USGS topographic maps are required for data tracking and provide important information for identifying segment boundary locations and access points. Information on channel width and survey reach length provided by the TFW Reference Point Survey are used to characterize the frequency, distribution, and location of sample sites.

Basic study design elements include: selection of monitoring sites, timing of surveys, sample method options, sample processing options, survey modification options, and pre-season crew training and quality assurance reviews.

2.1 Selection of Monitoring Segments

This methodology characterizes spawning gravel composition at the stream segment scale. The TFW stream segment is used as the fundamental unit of analysis. This section provides guidelines for determining which segments are best suited to gravel sampling and then identifying the logistically feasible sampling reaches within it. Additional criteria used to select monitoring segments includes land management practices affect-

ing the channel and current, historic, or future potential salmonid use.

2.1.1 Identify Sampling Segments

One or more sampling segments are selected based on survey suitability and other study design factors. The TFW method identifies stream segments by gradient, valley confinement, and flow. A USGS 7.5 minute topographic map (photocopy worksheet) with delineated segments is required for this part of the study design development. Many streams have already been segmented through past TFW monitoring projects, Watershed Analysis processes, and the Salmon and Steelhead Habitat Inventory and Assessment Project (SSHIAP). If the stream has not been pre-segmented, or pre-segmented boundaries are not suitable for your study design, partition the river system into stream segments using the TFW Monitoring Stream Segment Identification method (Pleus and Schuett-Hames, 1998) before continuing.

Once a stream segment map is generated, a list of segments are identified and rated for suitability. The first step is to identify all stream segments in the area of interest with gradients less than 2 %. The SG Comp Survey is best suited in stream reaches having pool-riffle sequences, and these are typically found in segments with gradients less than 2 % (Figure 1). Next, identify all segments in the 2 to 6 % gradient range. Field verification of the segment gradient is necessary to determine which 4 to 8% gradient segments are suitable for sampling. Spawning gravels in these segments tend to occur in smaller isolated patches and there are more problems collecting samples due to equipment limitations. Segments with gradients over 6% are generally unsuitable for this survey as gravel sizes become too large and spawning gravel patches too small for the sample collection equipment.

2.1.2 Identify Logistically Feasible Sampling Areas Within the Segment

The next step is to identify which portions of the selected segment are suitable for sampling and to elimi-

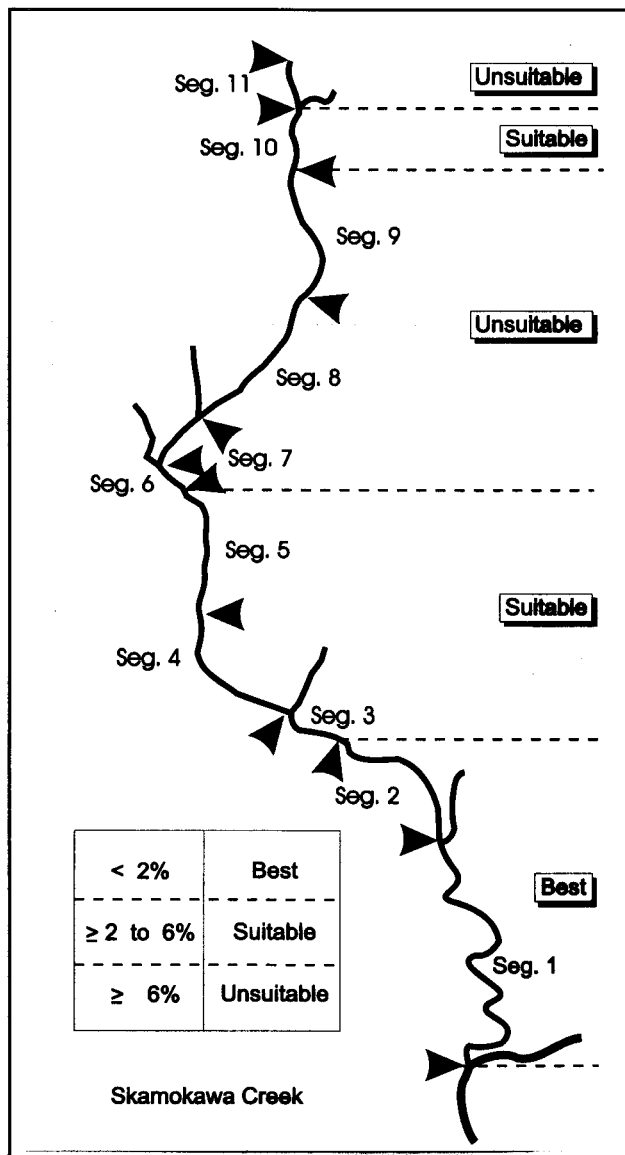

Figure 1. Suitability of gravel sampling by segment and gradient.

nate portions where sampling is not recommended or logistically impractical. Sampling is not recommended on stream reaches within the segment that would characterize local rather than the whole channel influences. Also, sampling on some stream reaches within the segment may not be logistically feasible due to equipment bulk and weight, sample transport limitations, or crew safety. This section provides guidelines on how to identify those portions of stream segments for elimination from the study design.

Use the topographic map, aerial photographs, and other resources to identify known or suspected human structures and disturbance in the stream channel. Mark their

locations on the topographic map worksheet (Figure 2). Include factors that affect sediment deposition patterns such as bridges, culverts, weirs, dams, bank protection, and fords that locally alter hydraulic conditions in stream channels. Samples taken in the vicinity of these structures or disturbances reflect the local effects of the structure and mask the overall effect of watershed conditions on the stream channel. The area of influence is related to the structure and stream's size, gradient, and confinement and boundaries are identified in the field.

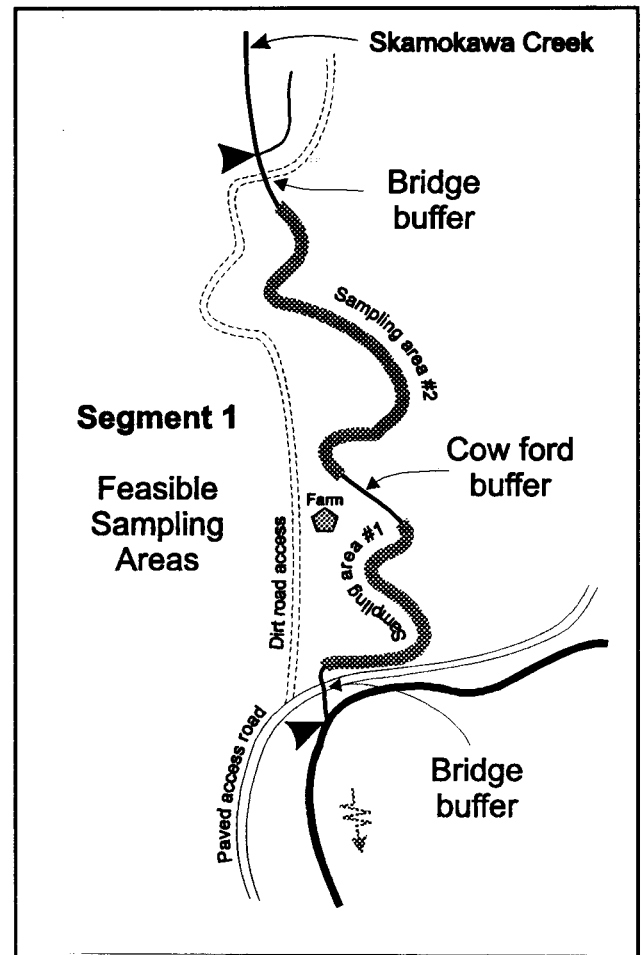

Figure 2. Determining and finalizing potential sampling areas in segments 1 and 2 based on topographic map and local knowledge. The circular areas are the finalized areas for sampling.

The same resources are then used to identify and mark the downstream and upstream boundaries of known or suspected segment areas where sampling is not logistically feasible. Start by identifying potential access roads and trails. Then identify terrain or other factors that may impede access or affect crew safety. Determine

how far it is feasible for crews to transport equipment and samples to and from the marked access points. This will depend on the terrain and the physical strength and endurance of those transporting the samples. Transporting samples for distances greater than 0.75 - 1.0 kilometers is probably not practical in most cases as total carry-out weight of equipment and samples often exceeds 500 pounds per segment. Alternative transport systems such as helicopters or boats may allow better access.

Once these areas have been eliminated from the study design, the remainder of the segment is available for sampling. In situations where multiple areas must be eliminated, review the monitoring plan to see if the segment would still meet its objectives.

2.2 Timing of Surveys

The ideal time to sample is in the late summer/early fall low flow period when conditions are the most stable and similar to those encountered by salmonids when they begin to spawn. Sampling should be conducted during moderate to low flow conditions to provide a management indicator of substrate composition that can be used to compare stream reaches and determine trends over time. If you are unfamiliar with the hydrologic regime of the stream to be sampled, consult with people familiar with the system or refer to USGS stream flow records to determine an appropriate sampling period. However, avoid working in the channel during spawning or when there are eggs in the gravel to prevent unnecessary disturbance and mortality to salmonid populations.

Timing is an important study design factor as spawning gravel composition (especially fine sediment levels) in a stream reach can vary over the course of the year. This is illustrated in research conducted on western Oregon streams that showed substrate composition being relatively stable from early summer to early fall, and most variable during the winter storm season when peak flows mobilized the substrate and the processes of fine sediment infiltration were most active (Adams and Beschta, 1980).

Collecting spawning gravel samples during extremely low flow conditions is also to be avoided, because only a small portion of the potentially available spawning habitat will be wetted. This may introduce bias into

site selection. Dry gravel areas within the channel are not included in the TFW sample design as the potential effect this may have on the sampling process or the composition of the sample is unknown.

2.3 Sample Method Options

A sampling method must be chosen for the collection of a minimum of 12 gravel composition samples per segment. Two options are available: (1) the riffle crest sample method, and (2) the gravel patch sample method.

The riffle crest sampling method is the preferred strategy, because it allows the most consistent and reproducible sampling at a specific geomorphic feature. Also, riffle crests are located at the transition between riffles and pools, the two areas most heavily utilized for spawning by salmonids. The riffle crest sampling method is most commonly used in segments with gradients less than 2 percent due to their potential for having optimal substrate size and pool/riffle characteristics.

The gravel patch method is used where there are not enough riffle crests to provide the minimum 12 samples. This occurs most often on steeper streams with gradients between 2 and 6 percent where pool-riffle sequences are less well defined and the riffle crests contain larger particles. In these situations, spawning gravels are typically found in patches associated with obstructions or the tailouts of large pools. A sampling transect technique has been developed as a framework for the objective characterization of spawning gravel composition within a given gravel patch. This technique divides patches along their length into equal sections and transect points are established at the center of each section. The sample inventory using this method requires more time and calculations for estimating the number of potential samples within a segment. The patch method may be used on lower gradient streams in situations where there is a lack of riffle crest features, significant obstructions preventing use of the gravel sampler, or armoring of the bed surface. Stream segments with gradients greater than 6% are the least likely to have a suitable number of either riffle crest or patch sampling sites.

2.4 Sample Processing Options

Once riffle crests or patches have been inventoried and

samples are collected from the stream, a sample processing method must be chosen. Two options are available: (1) the volumetric processing method, and (2) the gravimetric processing method.

The volumetric (wet) processing method uses a manual shaking and washing technique to sort the sample and allow the smaller gravel particles to move downward through the sieve stack until they are retained on a sieve corresponding to their proper particle size class. The volume (milliliters) of sample particles retained on each sieve is then measured by using a displacement technique. The volumetric method is quicker and requires less equipment, reducing processing costs, but it provides greater potential for inaccuracies.

The gravimetric (dry) method is conceptually similar to that of the volumetric method, with the main differences involving drying of samples and weighing of sample class sizes. Each sample must be oven-dried prior to sieve sorting. A mechanical shaker is then used to sort the sample and allow the smaller gravel particles to move downward through the sieve stack until they are retained on a sieve corresponding to their proper particle size class. The weight (grams) of particles retained on each sieve are then measured by using a level or beam balance. The greater labor and more elaborate equipment required by the gravimetric method make it more expensive, but the procedure eliminates many potential sources of inaccuracy and provides data meeting geology and engineering standards. This method is not advised for streams with substrate materials that tend to fracture when heated.

Both processing methods use the same progressive sieve series for sorting individual gravel samples into their size classes. The volume or weight of contents retained on each sieve is measured for analysis of overall composition and fine sediment levels. The choice of methods is left to the cooperator depending on data needs and the time and equipment available. During data analysis, gravimetric data will be converted to volumetric equivalents and vice-versa.

2.5 Survey Modification Options

Contact the TFW Monitoring Program for assistance when modifying the methods. We encourage the collection of additional information useful for individual cooperator monitoring plans. However, the integrity of

the core TFW methods is required for consistent data collection, standard analysis, and will help ensure that data from different monitoring projects are comparable.

2.6 Pre-Season Crew Training and Quality Assurance Reviews

Appointments should be made with the TFW Monitoring Program for pre-season training and quality assurance reviews. Annual training workshops are provided and on-site training is available. Repeat training is encouraged to learn new methods and techniques or refresh skills. A training video of this survey is available for loan or purchase. Pre-season quality assurance reviews provide the highest level of documentation that crews are applying the methods in an accurate and consistent manner *before* collecting project data.

3. Sample Inventory

A sample inventory is conducted on all stream segments included in the study design prior to collection of spawning gravel samples. This part of the SG Comp Survey provides segment verification of sampling and non-sampling areas, sample population data for selecting and relocating sampling sites, and documentation of channel conditions. This section is divided into pre-inventory tasks, riffle crest and gravel patch inventory methods, and post-inventory tasks.

3.1 Pre-Inventory Tasks

Gather, prepare, record, and pack for transportation all necessary survey equipment and materials required for field crews to complete the field portion of the sample inventory.

3.1.1 Inventory Equipment

Inventory equipment are those items necessary for crews to conduct the sample inventory and measure site and channel parameters. The TFW-MP database is designed to use metric units so metric measurement equipment should be used.

Inventory Equipment

- ◆ Hip-chain (w/bio-degradable string)
- ◆ Measuring tape (30+ meters)
- ◆ Measuring Rod (5 - 7 meters)
- ◆ Field vehicle
- ◆ Standard field and vehicle gear (Appendix C)

Check all measurement equipment for damage and calibrate to document accuracy. TFW-MP recommends calibrating all measurement equipment to a known accurate standard both before and after the survey to meet quality assurance plan monitoring requirements. Determine the type of vehicle and safety gear required.

The use of metric measurement equipment complies with standard scientific methods. The cost of purchasing metric equipment is often offset by savings in per-

sonnel time and effort required to convert from English to metric units, and results in the highest quality data due to avoidance of errors during conversion of large data sets. Mixing unit types within a survey is strongly discouraged due to potential for multiple conversion errors. If using English units, all measurements must be converted to metric units before entry into the TFW-MP database.

3.1.2 Inventory Materials

Inventory materials are those items necessary for crews to locate and document the stream segment and access points, plus field forms for documenting sampling site locations and characteristics.

Inventory Materials

- ◆ USGS 7.5 minute topographic map worksheet
- ◆ Road map
- ◆ Copy of segment's Form 1.0 and 2.0
- ◆ Form 6.0 and 6.1 copy masters (Appendix A)

Supplemental materials

- ◆ Aerial photos in waterproof/clear case
- ◆ Timber/Landowner road/resource maps
- ◆ Watershed Analysis Segment maps
- ◆ SSHIAP maps
- ◆ Survey data from resource agencies

Start by gathering and organizing stream site access information and logistical factors. This includes: obtaining directions and maps; contacting landowners and securing permission to access property; acquiring necessary permits and passes; and determining if the access roads are gated and get gate keys or make necessary arrangements with landowner to open access. Next, begin the survey documentation by preparing and fill-out header and inventory field forms.

Form 6.0 "HEADER INFORMATION"

Use the Form 6.0 copy master to make one copy on regular white paper for office files (Figure 3). Most of the header information can be copied directly from the segment's completed Form 1. The Study Design Information, Sample Inventory, Sample Collection, Sample Processing, and Survey Notes portions of the form will be covered in Section 6 of the manual. The Water Resource Inventory Area number (WRIA #), unlisted tributary number (Unlisted Trib), segment number (Segment #), Sub-Segment Code, and Date are key fields used to identify unique monitoring segments for the TFW-MP database, so they must be filled in on every form copy used. Refer to Appendix B for examples of completed field forms.

Figure 3. SG Comp Survey "Header Information" Form 6.0.

Stream Name: Record the WRIA-designated stream name. Use "Unnamed" where appropriate.

WRIA #: Record the six digit Water Resource Inventory Area (WRIA) number (00.0000).

Unlisted Trib: Record the three digit cooperator-designated unlisted tributary number (001 - 999) and mark the appropriate RB/LB circle (leave blank otherwise).

Segment #: Record the one to three digit segment number (1 - 999).

Sub-Segment Code: Record the one or two letter character sub-segment code (a - z; aa - zz).

Date: Enter the date the form is being filled-out. The

date documents the time line of this portion of your monitoring plan. It also is a reference to the manual version used to survey the stream.

Survey Crew: Record the names and affiliations of all the field crew involved in data collection for the survey. Fill-in the appropriate circle(s) of lead responsibilities and participation in survey sections. Affiliations correspond to employers such as a tribe, government agency, industry, environmental group, consulting company, etc.

Crew Lead Experience: Mark the appropriate circle(s) corresponding to the year(s) the lead crew person received official TFW Monitoring Program on-site and/or annual workshop SG Comp Survey training, and/or a QA Review. Note any other relevant training or field experience.

Equipment: As equipment is selected for conducting the SG Comp Survey, document the equipment type, size, condition, measurement accuracy, and pre-survey calibration dates as indicated. Mark the appropriate circle corresponding to whether equipment is in metric or English units. Document the type of wading gear used (wet/knee/hip/chest/dry/swim/etc.). Document any other measurement equipment used during the survey.

Form 6.1R "RIFFLE CREST INVENTORY"
Form 6.1P "PATCH INVENTORY"

Use the copy master to make one copy on regular white paper for copy purposes (Figures 4 and 5). Record the Stream Name/WRIA #/Unlisted Trib/Segment #/Sub-

Figure 4. SG Comp Survey "Riffle Crest Inventory" Form 6.1R.

and secure area downstream of the site to allow greater flexibility to examine the sampling site.

Cumulative Distance Measurement Technique

Cumulative distance is measured along the center line of the bankfull channel. Anchor the end of the hip chain line to an object at the last transect's midpoint in the bankfull channel. Proceed up the center of the bankfull channel, staying midway between the banks and following the curvature of the channel (Figure 6). Anchor the hip chain line to objects along the channel to maintain proper position, especially when going around channel meanders. Pieces of branches pushed into the gravel are useful as anchor points. Follow the center line within the limits of personal safety and accessibility.

The cumulative distance for a riffle crest or other feature located at the lower segment boundary is "0". Each subsequent feature's cumulative distance reflects its total distance from the lower segment boundary as measured along the center line of the bankfull channel.

Cumulative distance is measured to the upstream segment boundary. Using this system, the distance of a riffle crest from the nearest landmark or reference point can be calculated for backup relocation purposes.

Difficult Situations

In situations where a non-sampling section of stream cannot be measured along the channel, record the distance to the downstream point and break off the line. Estimate the distance to the upstream point where the sample inventory can continue and either continue the distance measurement where left off or zero-out the hip chain. Marking the location on aerial photographs provides another level of documentation.

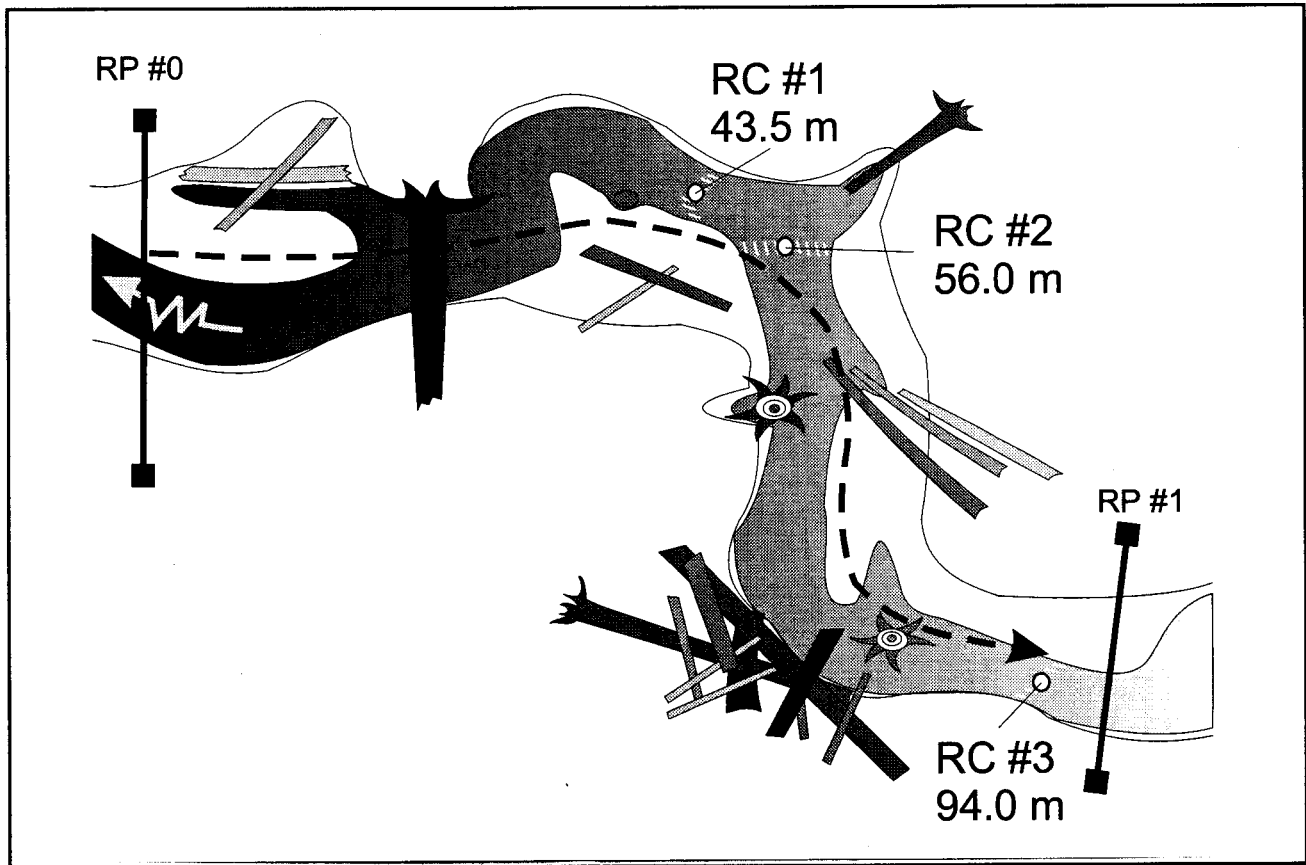

Figure 6. Walk up the center of the bankfull channel and record reference point numbers and landmark structures as measured distance from the downstream segment boundary along the center of the bankfull channel.

Step 2: Determine suitability of the candidate riffle crests.

General Procedure

Riffle crests suitable for inventory must meet all five spawning gravel criteria including:

- 1) Dominated by spawning gravels between 8 and < 100 millimeters;
- 2) Minimum surface area of 1 square meter and 0.5 meter width (2.0 m length);
- 3) In the wetted channel under flowing water;
- 4) Water depth less than 0.3 meters; and
- 5) Obstructions do not affect criteria #2.

Record a unique riffle crest number ("Riffle Crest RC #" column) as each suitable riffle crest is identified. Begin at the downstream end of the segment and assign riffle crest numbers sequentially (1, 2, 3, ...) until the upstream end of the segment. Record the distance ("Dis-

tance" column) measured where the center of the riffle crest intersects the centerline of the bankfull channel at a 90 degree angle.

Riffle Crest Identification Techniques

The term "riffle crest" refers to a specific geomorphic feature that is found within the wetted portion of the channel. It is commonly the transitional area between an upstream pool and a downstream riffle (Lisle, 1987), but can also be found between an upstream pool and a downstream pool or cascade (Figure 7). The riffle crest is a line that identifies the highest points in bed elevation along the unit boundary as viewed in a longitudinal profile.

SG Comp and Habitat Unit Survey quality assurance reviews indicate that most crew can readily identify the presence of a riffle crest, but have difficulty in identifying the actual riffle crest line along the highest elevation. The following technique provides a systematic process for consistent riffle crest line identification.

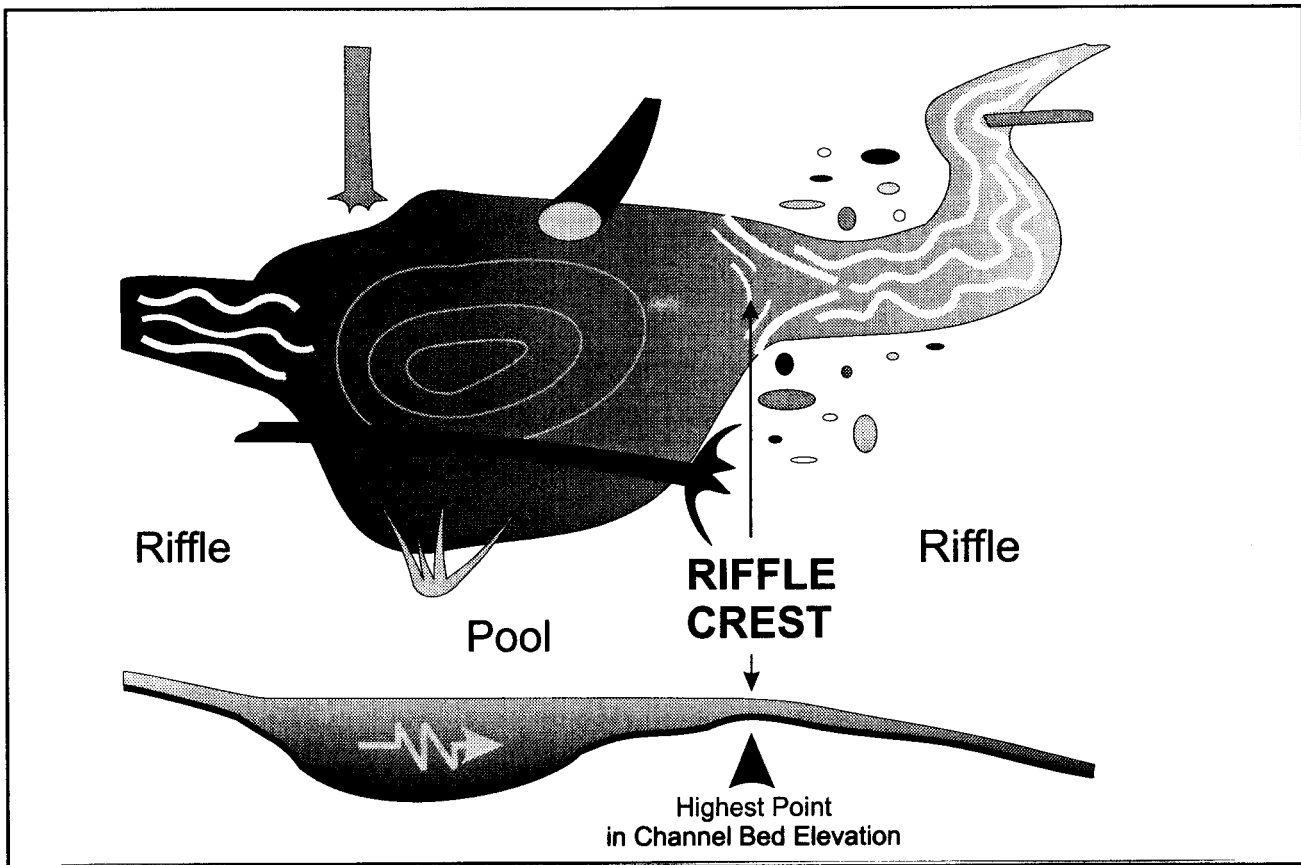

Figure 7. The riffle crest is a specific geomorphic feature found within the wetted channel and identified as a line along the highest points in bed elevation between an upstream pool and most commonly, a downstream riffle.

Consistent riffle crest identification between riffle and pool habitats first requires the ability to positively identify those habitat types. The most useful indicators are grouped by hydraulic and geomorphic characteristics (Table 1). Riffles are stream reaches that have relatively shallower (-) water depths, greater (+) water speed and surface turbulence, steady upstream (+) bed elevation increases, a flatter (-) channel bed cross section shape, and larger (+) gravel sizes. Pool indicators show generally opposite characteristics such as relatively increasing (+) water depths, decreased (-) water speed and surface turbulence, a decrease (-) in bed elevation until the pool's deepest point, a curved or cupped (+) channel bed cross section shape, and smaller (-) sediment sizes. Refer to the TFW Habitat Unit Survey (Pleus and Schuett-Hames, 1999) for more habitat unit identification information.

Table 1. Hydraulic and geomorphic indicators of riffle and pool habitat types.

Indicators	Riffle	Pool
<i>Hydraulic</i>		
Water Depth	-	+
Water Speed	+	-
Surface Turbulence	+	-
<i>Geomorphic</i>		
Bed Elevation	+	-/+
Bed Cross Section Shape	-	+
Gravel Size	+	-

Once the unit types have been positively identified, the next step is to focus attention on the transitional area between them. Based on the available indicators and crew experience, a confidence range is identified across the channel using weighted flags (Figure 8). As viewed from the riffle, a downstream flag marks the point where the crew is no longer 100 percent confident they are still within the riffle. As viewed from the pool, an upstream flag marks the point where the crew is no longer 100 percent confident they are within the pool. This technique can be applied at several points across the channel in complex situations. The riffle crest is identified as a line formed through the center of the confidence range.

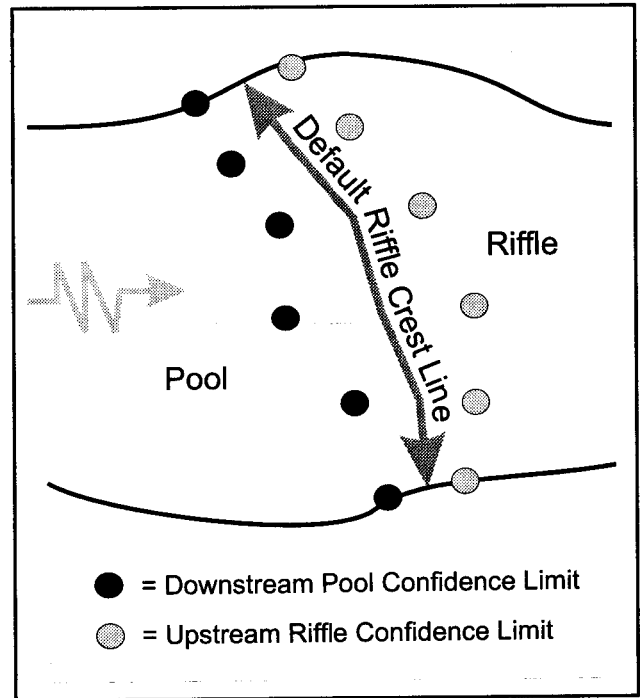

Figure 8. Using weighted flags to identify the pool and riffle confidence range and default riffle crest line.

Dominant Spawning Gravel Identification Techniques

Spawning gravel is defined as a range of particle sizes between 8 and 100 millimeters (Figure 9). The upper range is due to sampling equipment limitations. Particle size is determined by measuring across its b-axis using a caliper or ruler (Figure 10). Of the three axes that define the dimensions of a particle, the b-axis is intermediate between longest and shortest axes. After some practice, it is often possible to accurately esti-

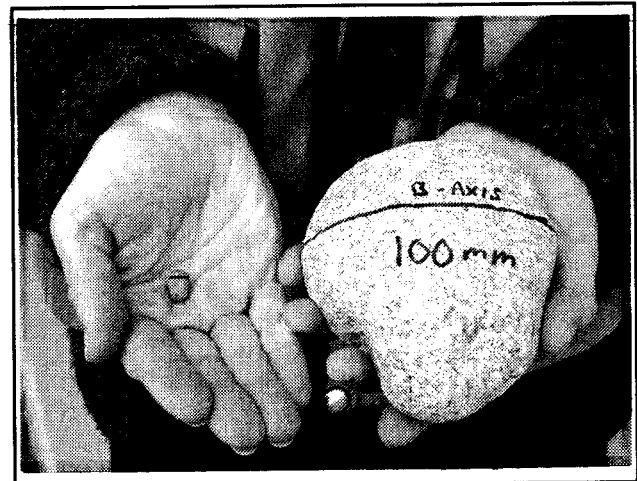

Figure 9. Crew holding an 8 and a 100 millimeter particle that shows the size range of spawning gravel.

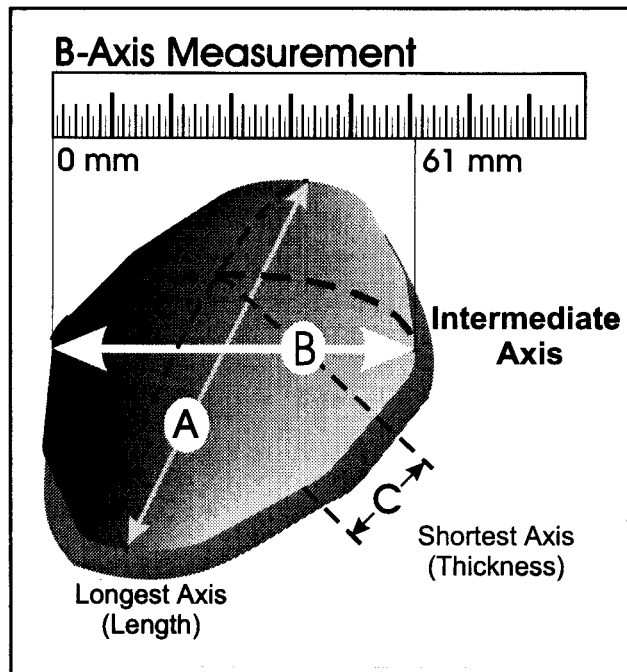

Figure 10. Particle size is determined by measuring across its b-axis using a caliper or ruler.

mate the size class of a particle without using a measuring device unless it is near the range limits. Estimates require checking periodically to ensure accuracy. Along a riffle crest, it is necessary to identify the area of dominant spawning gravel suitable for sampling. To qualify, areas of dominant spawning gravel must be equal to or greater than one square meter ($\geq 1.0 \text{ m}^2$). Minimum surface area criteria can be interpreted as either 0.5 meter wide and 2.0 meters in length, or 1.0 meter wide and 1.0 meter long (Schuett-Hames and Pleus, 1999).

When determining whether spawning gravel is the dominant substrate size, it is important to focus on surface area – not number of particles. Dominance is where more than half of the surface area is made up of a single size class. The greater area taken up by larger particles means fewer of them are required to be considered dominant. Pick up representative dominant particles and measure them to determine size class. Portions of a riffle crest dominated by smaller ($< 8 \text{ mm}$) or larger ($\geq 100 \text{ mm}$) sediment particle sizes are not suitable for sampling.

Water Flow and Depth Identification Techniques

Water is considered flowing if movement is perceived other than that caused by wind. Test with a small piece

of twig. The wetted channel is the portion of the bankfull channel at the time of the survey that contains flowing water to the point along the edge where sediment particles are no longer surrounded by water. The maximum depth is related to equipment limitations and may vary with flow velocity and surface turbulence conditions. Use a stadia or other measuring rod to test depths. Samples can not be taken where water would flow into and out the top of the collection cylinder.

Sampling obstructions

Sampling obstructions are related to equipment limitations and include factors on, above, adjacent, or under the riffle crest that completely or partially prevent the collection of a sample. Obstructions above, adjacent to or on spawning gravel require a 0.5 meter buffer on either side. Obstructions under spawning gravel prevents samples from being collected to the required depth of 23 centimeters. Common obstructions are logs, sediment particles greater than 100 millimeters, and bedrock.

Step 3: Estimate number of potential samples.

General Procedure

Estimate the number of potential samples by measuring the width of the suitable spawning gravel across the riffle crest. Record one estimated sample for each meter of width up to a maximum of three in the "Samples EST #" column.

Sample Estimation Techniques

In situations where suitable spawning gravel dominates the entire riffle crest area, apply the criteria to the measured distance between the edges of the wetted channel along the riffle crest line (Figure 11). In situations where suitable spawning gravel is divided by non-sampling areas, apply the criteria to individual sections and add the estimated numbers together.

Step 4: Record optional riffle crest information.

Optional information can be recorded for each riffle crest. This information is useful for additional segment characterization, assistance for collection crews in site relocation, and to alert the collection crew of special sampling conditions or obstructions. Optional informa-

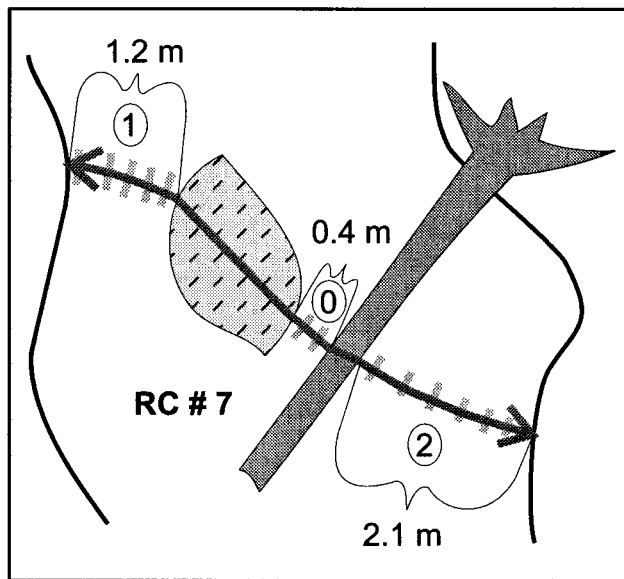

Figure 11. In this situation, the criteria was applied to individual sections and resulted in three estimated samples for RC #7.

tion includes: channel category, channel location, spawning gravel size, whether presence of larger particles, and collection obstructions. Other sample site or segment information can be recorded by adding columns in the "Field Notes" section, or by changing the existing optional column headings.

Channel category ("Chan. Cat. 1-3") uses the Habitat Unit Survey channel location category criteria to characterize the position of the riffle crest within the bankfull channel. A category "1" riffle crest spans more than 50 percent of the wetted channel width. A category "2" riffle crest spans less than 50 percent of the wetted channel width. These riffle crests are commonly found associated with small pools within larger riffles, or in adjacent channels separated from the main channel by a dry gravel bar. A category "3" riffle crest is located in a side channel that is separated from the main channel by an island. Refer to the Habitat Unit Survey (Pleus and Schuett-Hames, 1999) for complete channel location category protocols.

Channel location ("Channel Loc., RB, C, LB") is most useful for category 2 and 3 riffle crests as it identifies whether the riffle crest is located along the right bank ("RB"), center channel ("C"), or left bank ("LB"). Right and left bank are designated facing downstream. Use a check or "X" mark for all that apply.

Spawning gravel size ("SG Dom Sub Size Range")

characterizes whether the dominant spawning gravel along the riffle crest ranges in size from 8 to 100 millimeters or can be characterized in a narrower size classes such as "8 - 16 mm", "8 - 64 mm", or "32 - 96 mm."

The presence of *larger particles* ("Lrg Sub 100 mm+") can make collection of samples more difficult and time-consuming. A check mark or "Yes"/"No" documents whether one or more particles are present along the riffle crest.

Collection obstructions ("Collect. OBS") identifies whether there are sampling obstructions present along the riffle crest. Identify all obstructions that apply by abbreviation or name such as "LWD," "Boulder," "Bedrock," or "Roots."

Step 5: Place marked flagging adjacent to the sampling site.

Label a piece of survey flagging with a permanent marker identifying the riffle crest number ("RC # ___") and attach it to a feature as close as possible to the riffle crest site. The flagging provides quick relocation for crews returning at a later date to collect gravel samples on specific riffle crests. Once flagged, pick up the hip chain and proceed up the center of the bankfull channel until the next riffle crest is identified.

3.2.2 Option 2: Gravel Patch Inventory Procedure

The objective of the gravel patch inventory is to identify, characterize, and document the location of all suitable gravel patches within the entire segment. Start by verifying the lower segment boundary using reference point tags or other documentation. Organize inventory equipment and check the hip chain for proper function. Zero out the counter. Next, identify the intersection of the segment boundary and the center of the bankfull channel. Tie the zero end of the hip chain line to a secure object at this point.

There are five basic steps to the patch inventory method. These are: 1) Identify locations of reference points, landmarks, and candidate gravel patches; 2) Determine suitability of the candidate gravel patches; 3) Determine the number and location of patch transects; 4) Estimate number of potential samples and flag transect lo-

cations; and 5) Record patch and transect distance information.

Step 1: Identify locations of reference points, landmarks, and candidate gravel patches.

General Procedure

Walk up the center of the bankfull channel and record reference point numbers and landmark structures in the "Landmark RP #" column by type (bridge, culvert, ...) as encountered. Record their location as measured distance from the downstream segment boundary along the center of the bankfull channel in the "Distance" column. The downstream and upstream distance locations of non-sampling areas are also documented in the "D/DN" and "D/UP" columns and characterized in the field notes section. When a potential gravel patch is encountered stop to examine it, placing the hip chain in a dry and secure area downstream of the site to allow greater flexibility for the identification process.

Cumulative Distance Measurement Technique

Cumulative distance is measured along the center line of the bankfull channel using the following technique. Anchor the end of the hip chain line to an object at the last transect's midpoint in the bankfull channel. Proceed up the center of the bankfull channel, staying midway between the banks and following the curvature of the channel. Anchor the hip chain line to objects along the channel to maintain proper position, especially when going around channel meanders. Pieces of branches pushed into the gravel are useful as anchor points. Follow the center line within the limits of personal safety and accessibility.

The cumulative distance for a gravel patch or other feature located at the lower segment boundary is "0". Each subsequent feature's cumulative distance reflects its total distance from the lower segment boundary as it intersects the centerline of the bankfull channel at a 90 degree angle. Cumulative distance is measured to the upstream segment boundary. Using this system, the distance of a gravel patch from the nearest landmark or reference point can be calculated for backup relocation purposes.

Difficult Situations

In situations where a non-sampling section of stream cannot be measured along the channel, record the distance to the downstream point and break off the line. Estimate the distance to the upstream point where the sample inventory can continue and either continue the distance measurement where left off or zero-out the hip chain. Marking the location on aerial photographs provides another level of documentation.

Step 2: Determine suitability of the candidate gravel patches.

General Procedure

Gravel patches suitable for inventory must meet all five spawning gravel criteria including:

- 1) Dominated by spawning gravels between 8 and < 100 millimeters;
- 2) Minimum surface area of 1 square meter and 0.5 meter width (2.0 m length);
- 3) In the wetted channel under flowing water;
- 4) Water depth less than 0.3 meters; and
- 5) Obstructions do not affect criteria #2.

Locate the downstream start and upstream end of the patch and mark their locations with weighted flags.

Record a unique gravel patch number ("Patch P #" column) as each suitable gravel patch is identified. Begin at the downstream end of the segment and assign patch numbers sequentially (1, 2, 3, ...) until the upstream end of the segment.

Gravel Patch Identification Techniques

The term "gravel patch" covers a broad range of potential spawning gravel situations. They are found in both riffle and pool habitats. Basically, a patch is one contiguous formation of suitable spawning gravel as defined in the riffle crest identification section. Patches are most often located on the downstream side of an obstruction such as a log or boulder, in the tailout of a pool, across a riffle crest, along the submerged edge of a gravel point bar, and sometimes as a portion of a riffle unit. Patches can also be formed upstream of those obstructions that have sediment storage functions.

Single patches may only meet minimum criteria, or span several habitat types and geomorphic features. Patches are separated where completely divided by non-sampling areas or obstructions such as logs.

Step 3: Determine the number and location of patch transects.

General Procedure

Measure the length of the patch as it is oriented along the center of the bankfull channel with a measuring tape or rod. Record the measurement in the "Unit Length" column. Based on the patch length, determine the number and location of sampling transects and mark their positions along the channel with weighted flags. Record the transect numbers on separate rows in the "Trans. T#" column after the corresponding patch number. Transect numbers are assigned sequentially (1, 2, 3, ...) beginning at the downstream end of the segment until the upstream end of the segment.

Transect Identification Techniques

Table 2 provides the criteria for determining the number and locations of patch sampling transects as distance measured from the downstream patch boundary. Calculations are provided to simplify identification of transect points. For patch lengths between 1 and 2 meters, one transect is required and its location would

Table 2. Criteria for determining the number and locations of patch sampling transects.

Patch Length (m)	Number Transects	Transect Location (Patch Length multiplied by:)
≥ 1 and < 2	1	0.50
≥ 2 and < 4	2	0.25 and 0.75
≥ 4 and < 20	3	0.17, 0.50, and 0.83
≥ 20	4	0.13, 0.38, 0.63, and 0.88

be halfway (length multiplied by 0.50) between the downstream and upstream patch boundaries. Patch lengths between 2 and 4 meters require two sampling transects that are located by multiplying the total patch length by 0.25 and again by 0.75. Patch lengths between 4 and 20 meters require three sampling transects (length multiplied by 0.17, 0.50, and 0.83) and patches with lengths equal to or greater than 20 meters require four sampling transects (length multiplied by 0.13, 0.38, 0.63, and 0.88).

For example, a patch length of 1.8 meters would have one transect located at 0.9 meters as measured from the downstream end of the patch (Figure 12). A patch length of 3.5 meters would have two transects located at 0.9 and 2.6 meters (rounded to nearest 0.1 meter). A patch length of 6.0 meters would have three transects located at 1.0, 3.0, and 5.0 meters.

Step 4: Estimate number of potential samples and flag transect locations.

At each transect location, record the number of estimated sampling points in the "Sample EST. #" column. Label a piece of survey flagging with a permanent marker identifying the patch transect number ("T # __") and attach it to a feature as close as possible to the transect sampling site. The flagging provides quick relocation for crews returning at a later date to collect gravel samples on specific riffle crests.

Sample Estimation Techniques

Start by measuring the width of the suitable spawning gravel at the first transect. Transects are oriented at a 90 degree angle to the centerline of the bankfull channel (Figure 13). The criteria is the same as for riffle crests: record one estimated sample for each meter of width up to a maximum of 3.

Step 5: Record patch and transect distance information.

Pick up the hip chain and record the following distances measured along the centerline of the bankfull channel as flagging is intersected: patch lower boundary ("D/DN" column); transect sampling sites ("Distance" column); and patch upper boundary ("D/UP" column).

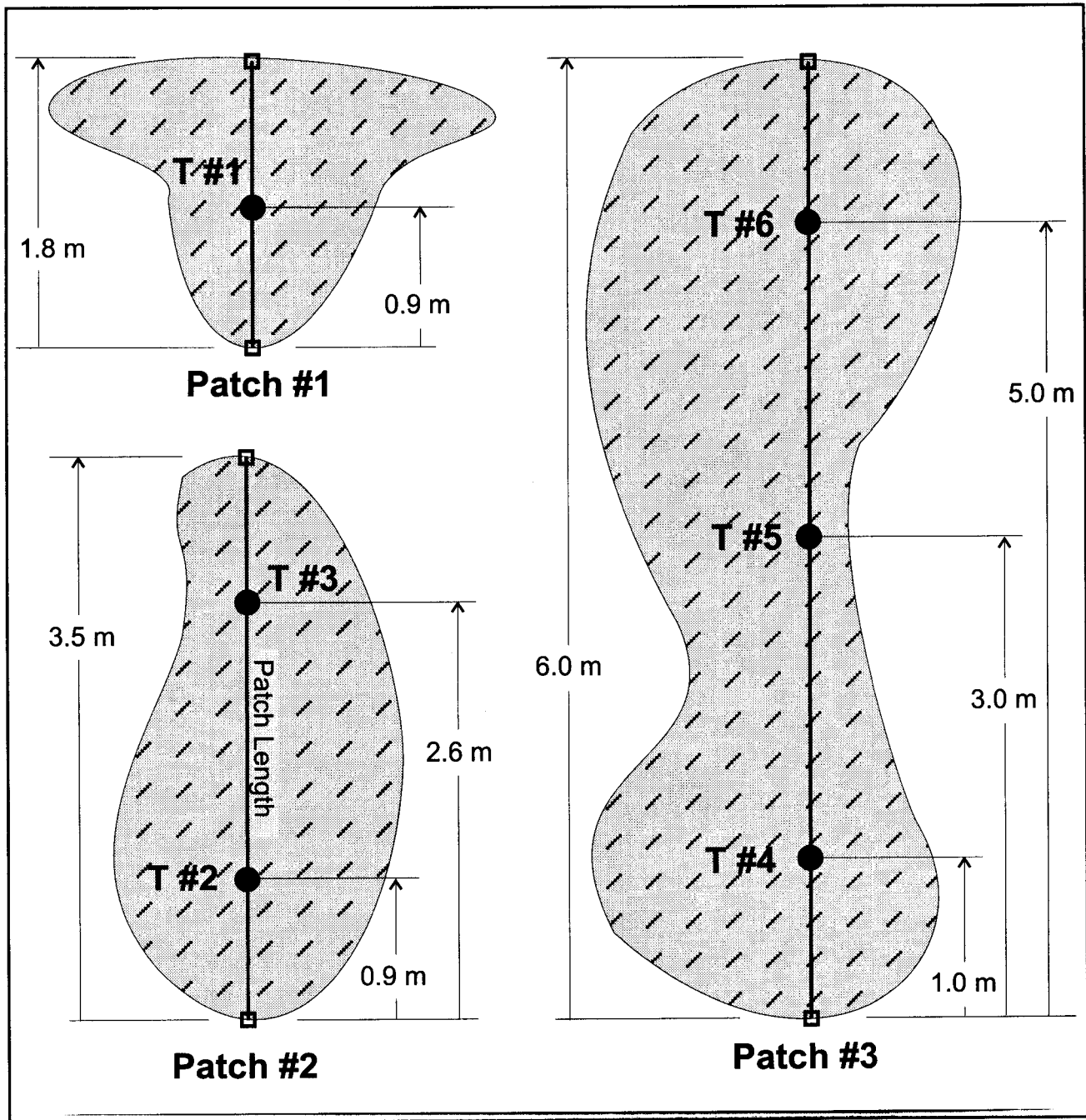

Figure 12. Three examples of measuring spawning gravel patch lengths and calculating transect locations.

Optional Information

Optional information can be recorded on Form 6.1P for each transect and/or sampling site. This information is useful for additional segment characterization, assistance for collection crews in site relocation, and to alert the collection crew of special sampling conditions or obstructions. Optional information includes: channel category, channel location, spawning gravel size,

whether presence of larger particles, and collection obstructions. Other sample site or segment information can be recorded by adding columns in the "Field Notes" section, or by changing the existing optional column headings. Refer to the "Riffle Crest Inventory Procedure" for instructions on collecting optional information.

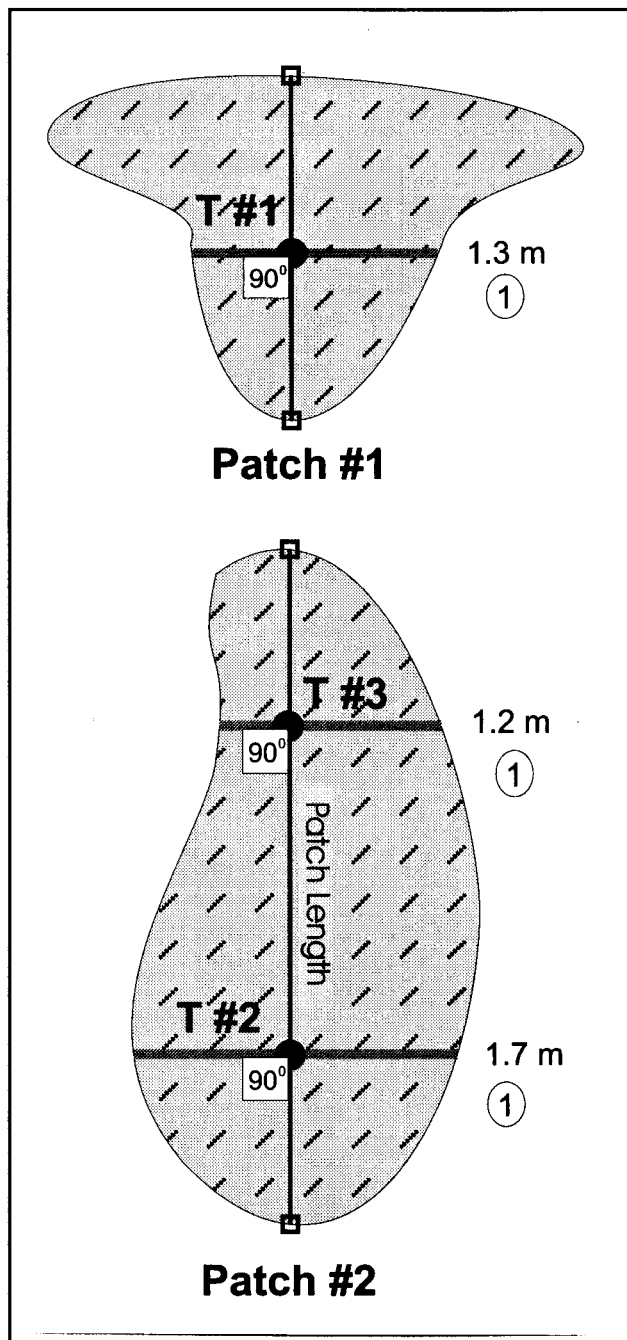

Figure 13. Two examples of measuring transect widths and estimating the number of samples.

3.3 Post-Inventory Tasks

At the end of the sample inventory, mark the blank row after the last inventory record "END OF INVENTORY" for documentation. Upon return to the office, ensure that all field forms are complete and organized and check your work to verify that no errors exist in the documentation. A systematic random sampling strat-

egy is used to select the number and location of riffle crests or gravel patches from which samples will be collected.

3.3.1 Sample Population Identification

The complete set of suitable riffle crests or gravel patch transects identified during the inventory constitutes the pool of sampling sites from which a final sampling population is determined. Count the number of estimated samples for all riffle crests (Form 6.1R) or gravel patches (Form 6.1P).

a.) If the total number of estimated samples falls between 12 and 18, the result constitutes your total sampling population from which 100 percent of the samples will be collected for segment characterization. Skip the rest of this section and go to the "Sample Collection" section.

b.) If the number is greater than 18, the result constitutes your sampling population from which a random sub-sample will be collected. Skip the rest of this section and go to the "Sub-Sample Population Identification" section.

c.) If the total estimated number of samples is below 12, there are several options based on inventory method used and segment conditions.

In situations where the riffle crest inventory was conducted, samples can simply be collected from the sites identified or the segment is re-inventoried using the gravel patch method. In situations where the gravel patch inventory was conducted and all patch lengths are less than 4 meters, the sample size adequately represents the segment conditions. In situations where one or more gravel patches were greater than 4 meters, the sample population can be increased by recalculating patch transect intervals using a smaller interval criteria. Transect locations are adjusted during the sample collection phase of the survey.

A low sample population could be the result of many factors such as stream and segment size, substrate armoring, or access. Ultimately, it is up to the cooperator to determine whether such a low sample population adequately characterizes their segment. A low sample population may also indicate that the segment is limited more by quantity rather than quality of spawning

habitat. In these situations, conducting the TFW Salmonid Spawning Habitat Availability Survey (Schuett-Hames et al., 1999) may be useful.

3.4.2 Sub-Sample Population Identification

The following systematic sub-sampling strategy was developed by examining four existing large data sets from Washington State to determine variation within and between riffle crests. It uses a two-part sample design with sampling sites (riffle crest or patch transects) as the primary units and estimated number of samples within the sampling sites as the secondary units. Systematic sub-sampling using a random starting point is recommended to avoid potential clustering, because fine sediments may systematically increase in a downstream direction where gradient decreases.

Based on the examination of existing data, a coefficient of variation less than 20 percent can be achieved for the segment by collecting up to a maximum of three samples per riffle crest and sampling as many riffle crests as possible, but no fewer than 10 percent of the total riffle crests. The following recommendations for sampling are based on the number of riffle crest or gravel patch transect sites inventoried in the stream segment. The objective is to maximize the distribution of sampling sites, but within the logistical constraint of keeping the total number of samples per segment under 20.

Part 1. Count the number of riffle crests (RC #) or patch transects (T #) inventoried for the segment. This number is applied to the first column in Table 3. Locate the row corresponding to the total number inventoried. Move along the row to the "Sub-Sample" column and identify the percentage of sites to be sampled based on the segment's total sampling site population. Continue along the row to the "Choose..." column and identify the range of numbers from which a random number is selected.

For example, if either 17 riffle crests or patch transects were inventoried, then the third row (13 - 18) is selected. The two pieces of information to carry on to the second step are a "33%" sub-sample and a random number selected between 1 and 3. Random numbers are selected using techniques such as a die (1-6), numbers in a hat, a random number generator, or a random number table (Appendix F).

Table 3. First part for systematic sub-sampling strategy based on total number of inventoried riffle crest or patch transect sampling sites.

Total Number RC or T	Sub-Sample	Choose a random number between
7-12	50%	1 and 2
13-18	33%	1 and 3
19-24	25%	1 and 4
25-30	20%	1 and 5
> 30	12.5%	1 and 8

Part 2. The random number selected in the first part is located in the "Random No." column on Table 4. Follow that row to the right until it intersects with its corresponding sub-sample percent from Table 3. The result is a list of the specific riffle crest or patch transect numbers from which samples are collected. Continuing the previous example, the number 2 is randomly selected and is associated with a 33% sub-sample strategy. The random number 2 row is identified and followed until it intersects with the 33% column. The resulting list requires samples to be collected from either riffle crest or patch transect numbers 2, 5, 8, 11, 14, and 17.

Cross-check the selected riffle crest or patch transect numbers with the inventory form and add together the estimated number of samples. If the total is less than 12 estimated samples, additional sampling sites must be randomly selected. In these cases, randomly select additional sampling sites as needed from the un-selected sample population using a random number table or generator.

Table 4. Second part for systematic sub-sampling strategy based on percent sub-sample identified in and random number selected from Table 3.

Random No.	50%	33%	25%	20%	12.5%
1	1, 3, 5, 7, 9, 11	1, 4, 7, 10, 13, 16	1, 5, 9, 13, 17, 21	1, 6, 11, 16, 21, 26	1, 9, 17, 25, 33, 41, etc.
2	2, 4, 6, 8, 10, 12	2, 5, 8, 11, 14, 17	2, 6, 10, 14, 18, 22	2, 7, 12, 17, 22, 27	2, 10, 18, 26, 34, 42, etc.
3		3, 6, 9, 12, 15, 18	3, 7, 11, 15, 19, 23	3, 8, 13, 18, 23, 28	3, 11, 19, 27, 35, 43, etc.
4			4, 8, 12, 16, 20, 24	4, 9, 14, 19, 24, 29	4, 12, 20, 28, 36, 44, etc.
5				5, 10, 15, 20, 25, 30	5, 13, 21, 29, 37, 45, etc.
6					6, 14, 22, 30, 38, 46, etc.
7					7, 15, 23, 31, 39, 47, etc.
8					8, 16, 24, 32, 40, 48, etc.

4. Sample Collection

The completion of the Sample Inventory provides a list of riffle crests or patches from which to collect spawning gravel composition samples. This section provides the pre-collection tasks, sample collection method, and post-collection tasks required for collecting spawning gravel samples at those sites.

4.1 Pre-Collection Tasks

Gather, prepare, record, and pack for transportation all necessary survey equipment and materials required for field crews to complete the field portion of the sample collection.

4.1.1 Collection Equipment

Collection equipment are those items necessary for crews to conduct the sample collection and measure site and channel parameters. The TFW-MP database is designed to use metric units.

Collection Equipment

- ◆ McNeil sampler with plunger
- ◆ Hip chain
- ◆ Measuring Tape (30, 50 or 100 meter, depending upon channel width)
- ◆ Plastic buckets (5 gallon) with lids- one per sample minimum
- ◆ Wash bottles (2)
- ◆ 150 millimeter ruler
- ◆ Sample tracking inserts (Appendix D)
- ◆ Standard field and vehicle gear (Appendix C)

Check all measurement equipment for damage and calibrate to document accuracy. Mark the outside of each bucket with a unique number using paint or a permanent marker. Determine the type of vehicle and safety gear required. The use of metric measurement equipment complies with standard scientific methods and the TFW Monitoring Program database.

4.1.2 Collection Materials

Collection materials are those items necessary for crews to relocate the stream segment and access points, plus field forms for documenting sample site collection locations and characteristics.

Collection Materials

- ◆ Completed Form 6.1R or 6.1P
- ◆ Form 6.2 copymaster (Appendix A)
- ◆ Map and directions to sampling site locations

Make a copy of all original completed inventory forms to take out in the field. This is used for locating and verifying sampling sites, especially those where the sample site identification flagging has been lost or removed.

Form 6.2 "SAMPLE COLLECTION"

Use the copy master to make one copy on regular white paper for copy purposes (Figure 14). Record the *Stream Name/WRIA #/Segment #/Sub-Segment Code* as documented on Form 6.0. Record the initials of the crew lead and others in the spaces provided in the upper right-hand corner. Mark the appropriate circle to identify

Figure 14. SG Comp Survey "Sample Collection" Form 6.2.

whether riffle crest or gravel patch information was collected during the survey. Leave the "Page ___ of ___" and "Date" fields blank as they must be recorded as the sheet is used in the field during the survey. Use this copy to make multiple field copies on waterproof paper such as "Rite in the Rain" brand. This process eliminates the need to fill out all header information on each form. Copies can be made single-sided or duplex. Two pages per segment is common.

Map and directions to sampling site locations: Use the same resources required for the sample inventory. The detail of maps and directions necessary should be documented at a level where someone unfamiliar with the study could relocate segment access and sample point locations.

4.2 Sample Collection Method

The McNeil gravel sampler has been specifically designed to collect a standard volume of spawning gravel to a depth of 23 centimeters. It weighs around 25 pounds. Its basic components consist of a coring cylinder, a collection cylinder, a coring handle, and the Koski plunger (Figure 15.) A stop ring welded to the interior of the coring cylinder provides a consistent marker for gauging the depth to which sediment is excavated and a platform for the plunger to rest upon when fully inserted. The plunger captures sediment-bearing water after extraction of the sample by way of a flapper valve.

There are five basic steps to the sample collection procedure. These are: 1) Locate and verify the selected sampling site; 2) Establish sampling points; 3) Collect spawning gravel sample at sampling point; 4) Transfer the sample into to a storage bucket; and 5) Sample documentation and tracking.

Step 1: Locate and verify the selected sampling site.

Locate the access path for the furthest downstream selected sampling site using the completed Form 6.1 and other documentation resources as needed. Pack the equipment required for the expected number of samples to be collected from the sampling sites associated with access point.

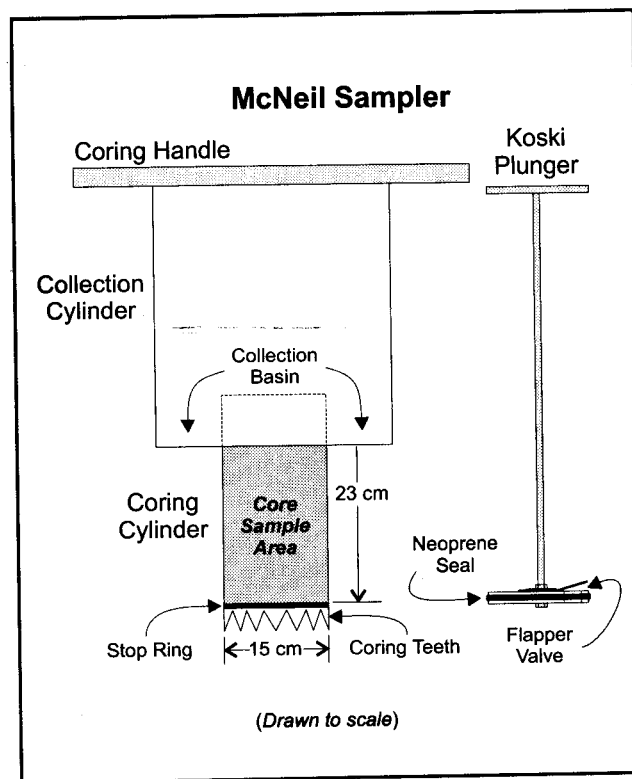

Figure 15. Schematic diagram of the McNeil Sampler.

Once on the stream, identify the selected riffle crest or patch by the marked flagging or, if missing, by the documentation noted on Form 6.1. Remember to avoid disturbing the sampling site area. Reconfirm the suitability of the riffle crest or patch according to hydraulic, geomorphic, and spawning gravel criteria outlined in the sample inventory section.

Step 2: Establish sampling points.

General Procedure

Identify and mark sampling point locations along the riffle crest or gravel patch transect. The general procedure includes establishing the measurement line and applying the sample point criteria.

Establish measurement line

Stretch the measuring tape across the spawning gravel dominated section along the top of the riffle crest or transect. For riffle crests, allow the tape to follow the shape of the riffle crest. For transects, measure in a straight line at a 90 degree angle oriented to the

centerline of the bankfull channel across the stream. Disregard small non-sample features within the sampling area (Figure 16). Secure the tape at one or both ends of the sampling area with a chaining pin or stick and a spring clip. The sampling point or points along the tape are then calculated.

Establish sampling points

The number of estimated samples per sampling site is based on the width of the sampling area across the channel (Table 5). Where the sampling width is equal to or greater than (\geq) 1 and less than ($<$) 2 meters, multiplying the actual width by 0.5 to identify the one sample point along the tape. Where the sampling width is ≥ 2 and < 3 meters, multiplying the actual width by 0.25 and again by 0.75 to identify the two sample points. Where the sampling width is ≥ 3 meters, multiplying the actual width by 0.17, 0.50, and again by 0.83 to identify the three sample points. Mark the sample point locations with weighted flags even if they fall on non-sample areas.

Table 5. Riffle crest sample point criteria.

Sample Area Width	Number Samples	Multiply Width by
$\geq 1.0 - 2.0$	1	0.50
$\geq 2.0 - 3.0$	2	0.25 and 0.75
$\geq 3.0 +$	3	0.17, 0.50, and 0.83

This system identifies the starting points for taking samples. If the spot selected is on non-sample features such as a small dry bar, too close to a log or boulder, or in still water, go to the nearest suitable location along the tape. If a sampling point is lightly covered with organic debris such as leaves or twigs, gently remove them without disturbing the gravel underneath. The tape, chaining pins and spring clips are then removed.

Step 3: Collect spawning gravel sample at sampling point.

General Procedure

The general procedure for the collection of spawning gravel composition samples includes rinsing the gravel sampler, selecting the sample point, inserting the sampler, excavating the sample, and inserting the Koski plunger.

Rinse sampler

Before taking a sample, remove the plunger and rinse the sampler to insure it is free of sediment, vegetation, or other debris. Make a quick check with a bare hand to verify.

Select sample point

Approach the sampling site from the downstream side, remove the flag and place the bottom of the coring cylinder where the flag was on the surface of the stream bed. The first sampling point is generally the furthest point downstream to minimize disturbance to other potential sampling areas.

Insert sampler

Firmly grasp the handle on top of the collection basin, placing one hand on each end of the handle on the outside of the basin (Figure 17). Square the sampler so that it is perpendicular to the channel bed. Apply upper

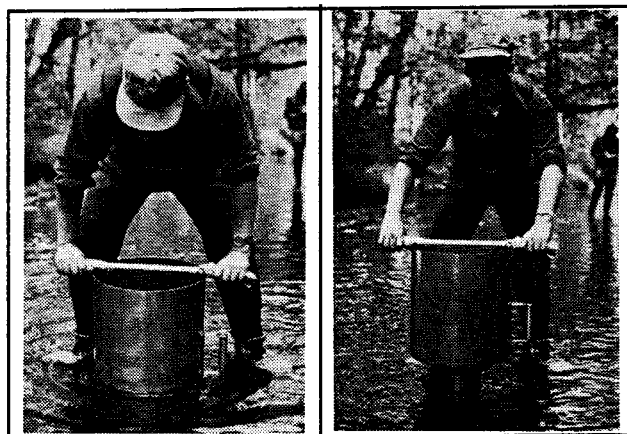

Figure 17. Grasp coring handle, square sampler, apply upper body weight, and use rotation technique to insert coring cylinder into stream bed.

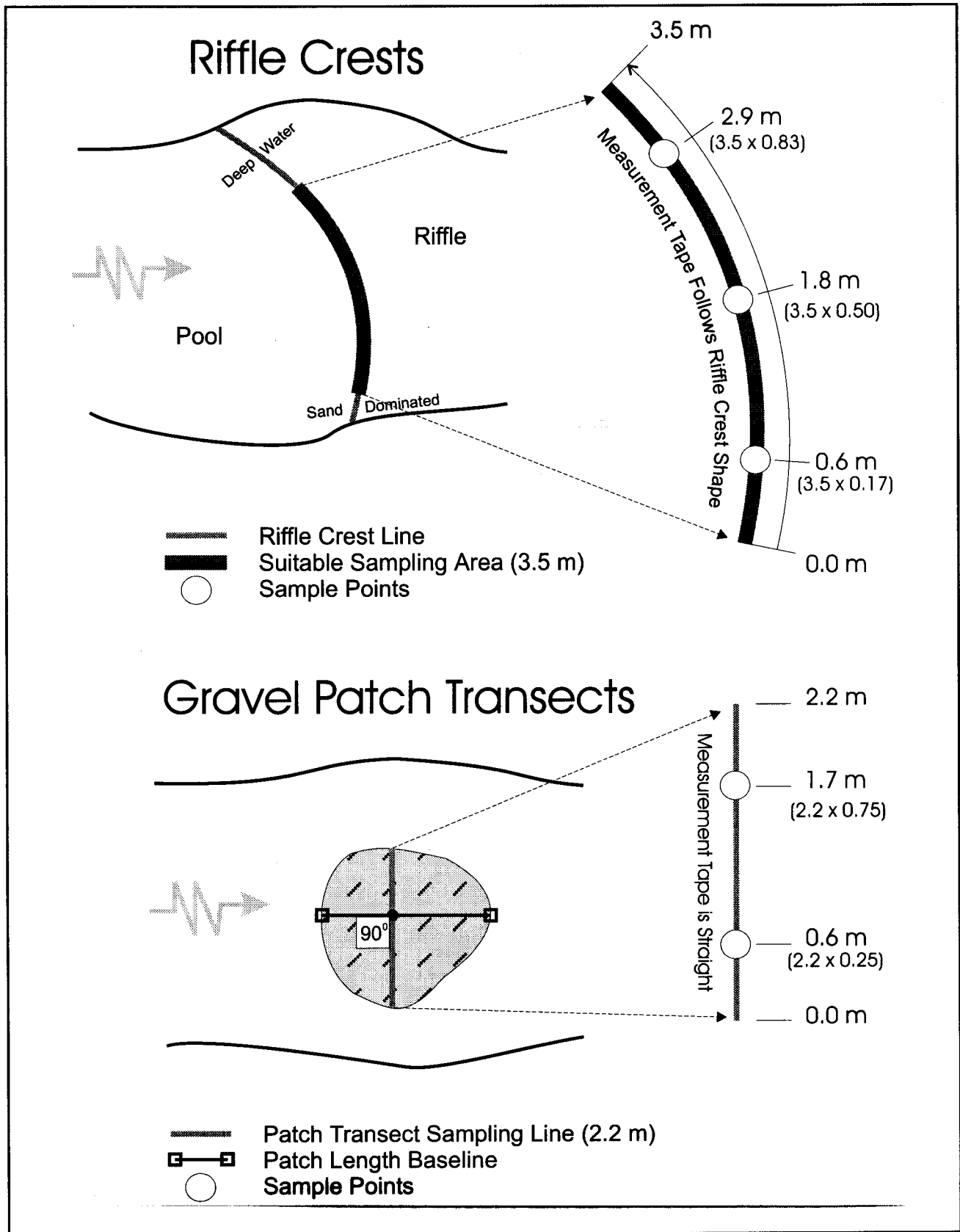

Figure 16. General technique for establishing measurement lines and sampling points along riffle crests and patch transects.

body weight directly over the coring handle. The McNeil sampler is worked into the stream bed using downward pressure and a rotation technique similar to the action of a washing machine. The rate of progress will depend on the size composition of the sediment and degree of armoring. Avoid side to side and up and down agitation as it causes fine sediment particles to filter down and be lost out the bottom of the coring cylinder. The sampler is fully inserted when the bottom of the collection cylinder is just resting on top of the stream bed (Figure 18). This is confirmed when fingers no longer fit between the bottom of the cylinder and the stream bed. Check points directly upstream, downstream, and towards the right and left banks. Work the sampler down until fingers cannot be inserted at a minimum of three of those points.

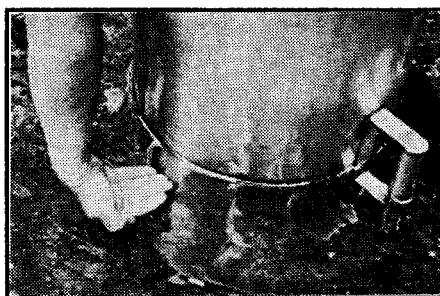

Figure 18. Using fingers to check for proper insertion at multiple points around the bottom of the collection cylinder .

Difficult sampler insertion situations

It is common for unseen obstructions, such as large substrate particles, wood, or bedrock to prevent the sampler from being fully inserted. In these situations, remove the sampler, rinse it out, and attempt another sample at the nearest undisturbed location along the original sampling line or the next sample point. New sample points cannot be established within 1 meter of the rejected sample point or an established sample point.

On many stream systems, it is common to take several coring attempts with the McNeil gravel sampler before a successful sample is taken due to unseen obstructions under the stream bed. In situations where all sample points are rejected, randomly select either the upstream or downstream adjacent riffle crest (flip a coin) and collect the samples at this location. Note this change on Form 6.2. This technique is also used for selecting additional riffle crest sampling sites where there is concern of meeting the minimum of 12 samples for the segment.

Excavate sample

Excavate the gravel slowly, layer by layer, using the hand as a scoop (Figure 19). This technique must be conducted bare-handed. Place the excavated material into the collection cylinder's donut-shaped basin. Rinse the hand in the basin water to remove clinging particles before taking another scoop. Add clean stream water to the basin if needed to provide rinse water. Repeat the scoop and rinse technique until the stop ring is reached. During the excavation process, there are three factors to focus on for preventing loss of fine sediments out the bottom of the coring cylinder and thus biasing a sample. First, keep fingers tightly closed as each handful is removed from the coring cylinder. When fingers are loose, finer particles easily fall through them back into the coring cylinder. Second, scoop rather than pluck out the larger particles. This action allows the surrounding

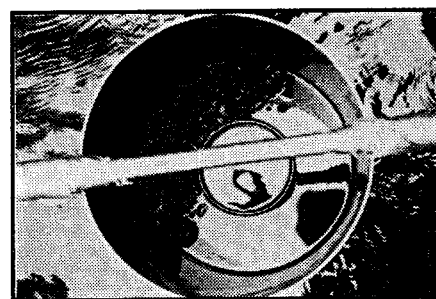
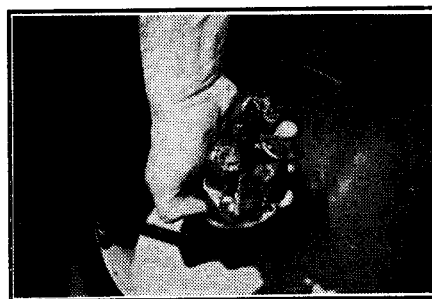

Figure 19. Excavate sample from coring cylinder using the hand as a scoop and placing material into the collection basin. Rinse hand in basin water between scoops.

finer particles to work their way down the coring cylinder. Third, always rinse the scooping hand in the collection basin water between each excavation. This prevents clinging particles from quickly washing off un-rinsed hands back into the coring cylinder.

Removal of the sample material is complete when the level of excavation is just below the top of the stop ring (Figure 20). Finger tips are used to check the level of

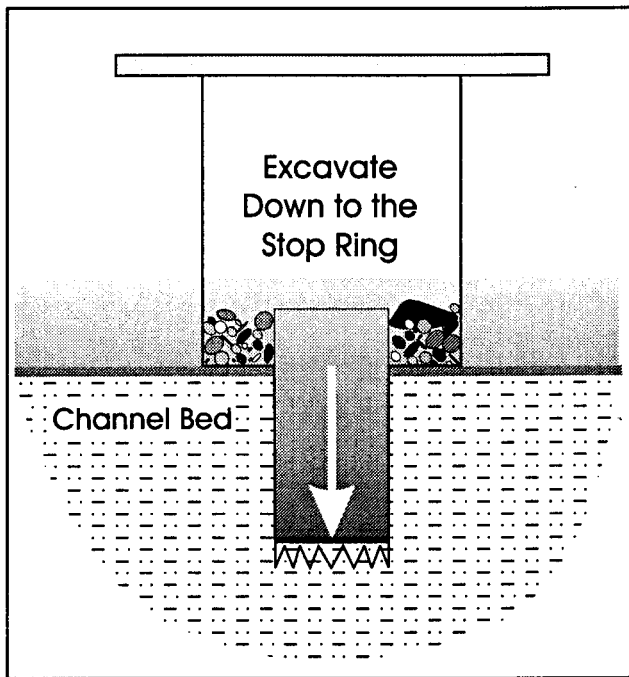

Figure 20. Remove sample material in coring cylinder down to just below the top of the stop ring.

excavation and position of the stop ring around the entire circumference of the coring cylinder. This is a fairly long reach for most crews with the hand inserted deeply into the coring cylinder and standing water.

Occasionally a larger particle will partially protrude above the ring. In these cases, the particle is removed along with the surrounding material to provide an unbiased sample (Figure 21). In situations where the protruding particle also extends below the bottom of the coring cylinder (top of teeth), the sample is rejected and another sample point selected.

When excavation is complete or when taking a break, use a wash bottle to rinse all clinging particles from hands, arms, or sleeves back into the collection basin - NOT back into the coring cylinder (Figure 22).

Insert Koski plunger

Rinse the plunger to insure it is free of sediment, veg-



Figure 22. Rinse all clinging particles from hands, arms, or sleeves back into the collection basin.

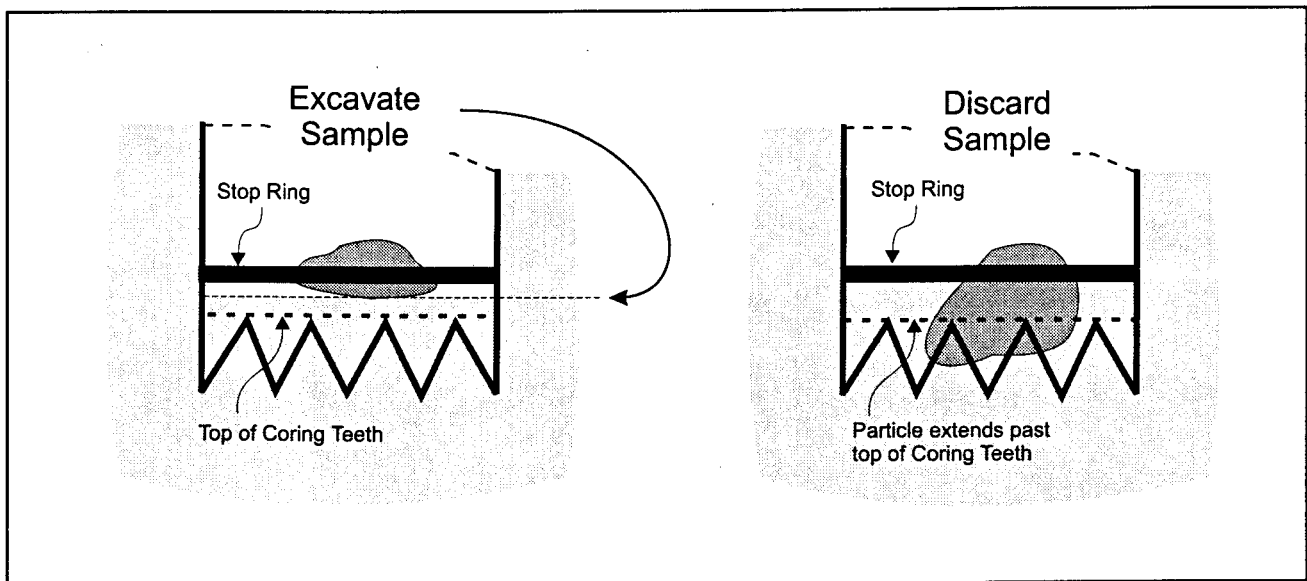

Figure 21. Stop ring protocol for particles extending below the stop ring and/or below the top of the coring teeth.

etation, or other debris and make a quick check with a bare hand to verify. Insert the clean plunger into the top of the coring cylinder (Figure 23) and slowly push it down in an even motion until it rests against the stop ring. The flapper valve should allow the suspended sediments to pass through, and be trapped in the coring cylinder. If the plunger is pushed too fast, suspended sediments are forced down into the substrate and lost out the bottom of the coring cylinder. Many McNeil samplers are designed so that when the plunger is fully inserted, the plunger handle fits just under the coring handle of the sampler.

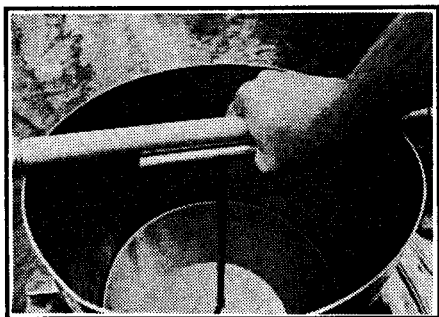
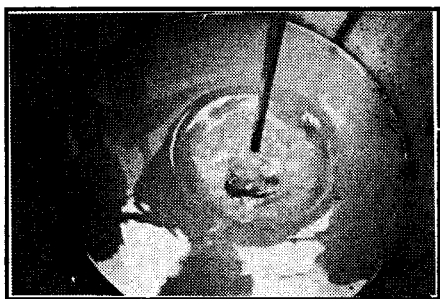

Figure 23. Rinse and then slowly insert the plunger into the top of the coring cylinder until it rests on the stop ring.

Step 4: Transfer the sample into to a storage bucket.

General Procedure

The general procedure for transferring the spawning gravel composition sample into a storage bucket in-

cludes preparing the storage bucket, transferring the sample, and rinsing the sampler.

Prepare storage bucket

Rinse out a 5 gallon bucket to ensure that it is free of sediment, vegetation, or other debris and make a quick check with a bare hand to verify. A second crew member positions and stabilizes the bucket at a short distance from the sampler. Avoid placing the bucket where it causes disturbance of other sample points or potential sampling areas. One bucket will usually hold an entire sample, however samples taken in deep areas contain more water and may require two buckets.

Transfer sample

Grasp the coring and carrying handles and in one smooth motion, lift the sampler out of the substrate and carefully pour the gravel and water from the sampler into the clean bucket (Figure 24). Too fast, and the sample may get spilled. Too slow, and the suspended sediments in the coring cylinder leak excessively out the bottom. This task requires strength, crew coordination, and proper lifting technique. Depending upon the situation, the crew could be lifting between 60 and 100 pounds from the combined weight of the sampler, sample, water, and initial resistance/vacuum of the buried coring cylinder.

Rinse sampler

After the first pour, wash bottles are used to systematically rinse clinging particles on the inside of the sampler into the storage bucket. Materials on the outside of the sampler are not part of the sample and must not enter the storage bucket. Rinse water added during this process becomes part of the sample and therefore, part of the weight that will be carried out in the storage bucket.

First, the crew stabilizing the bucket pulls the plunger out of the coring cylinder and thoroughly rinses it (Figure 25). Make sure to check the handle stem, under the flapper valve, around the neoprene seal, and on the bottom side of the disk. Second, rinse out the coring cylinder. Rinse particles from the bottom towards the top so that they are washed into either the collection cylinder or directly into the storage bucket. Third, set the sampler upright in the bucket and positioned a slight angle away from the carrying (side) handle. Rinse par-



Figure 24. Carefully pour the gravel and water from the sampler into a clean sample bucket.

ticles from the top towards the bottom of the collection cylinder so that they are grouped into the lowest portion of the basin. This includes rinsing around the outside of the coring cylinder wall that protrudes into the basin.

Lift and tip the sampler for a second pour into the storage bucket. The final rinse is required with the wash bottle positioned up at the collection basin so that clinging particles are rinsed towards the bucket. Use a bare hand to verify that the sampler is clean. Set the sampler aside and move the bucket to a dry stable area for recording information and sealing with a lid.

Step 5. Sample documentation and tracking.

General Procedure

Sample documentation and tracking includes recording sample information on Form 6.2, and completing and inserting a sample tracking slip into the storage bucket.

Form 6.2

Record sample collection information on Form 6.2. For each sample, note its riffle crest or patch transect

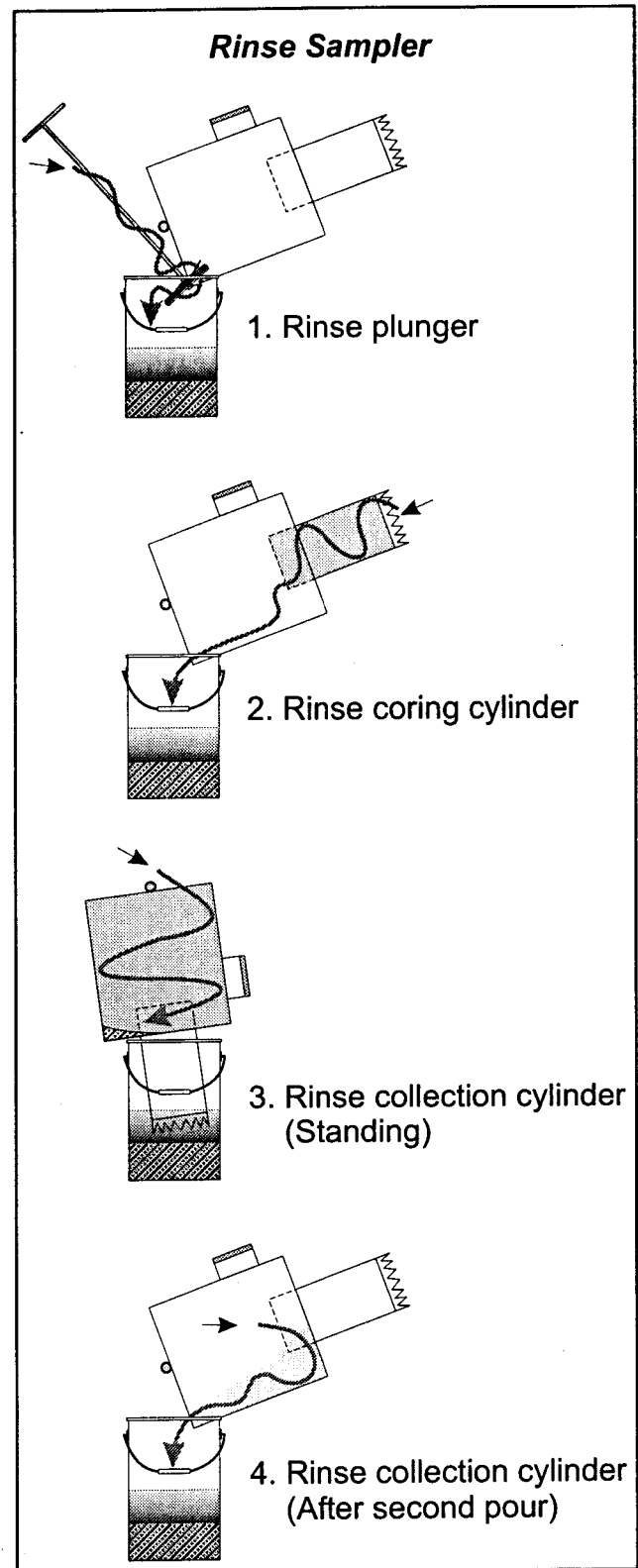

Figure 25. Four-step rinsing technique for final transfer of residual particles from the McNeil sampler into the sample bucket.

number (RC/T #) (circle appropriate type), sample number (Sample #), storage bucket number(s) (Bucket # __ + __), plus any notes related to sample quality or site characterization. Fill-in the "2 Bucket Sample" circle when appropriate.

Sample tracking slip

After completing the sample information on Form 6.2, a separate sample tracking slip is filled out and placed inside the storage bucket. Tracking slip information includes: collection date, stream name, WRIA and segment number, riffle-crest or patch number, sample number, bucket number, crew names and their affiliations (Figure 26). Place the tracking slip inside a zip-lock bag or film canister. Rinse the lid and seal the bucket. A tight fitting lid is essential for packing the sample out through rough terrain, transporting it back in the vehicle, and safe storage.

Decanting sample bucket water

The weight of the spawning gravel sample can be reduced by carefully decanting (draining) off the *clear* water in the sample bucket (Tripp and Poulin, 1986). The bucket must not be disturbed for a minimum of one hour before decanting. Where samples will be processed using the volumetric method, residual suspended sediments remaining after one hour settling can be drained off. This is most common on streams fed by glaciers. However, where samples will be processed using the gravimetric method, water containing residual suspended sediments is *not* drained off. Reseal the bucket and transport the entire sample for processing.

4.3 Post-Collection Tasks

At the end of the sample collection, mark the blank box after the last sample record "END OF COLLECTION" for documentation. Transport equipment and samples back to the office. Even on good trails, this is a rigorous and time-consuming process. In most situations, there are between 12 and 18 sample buckets to carry out per segment at an average weight of 45 pounds per bucket. Added together, a crew can expect to transport between 500 and 800 pounds in sample buckets alone.

Back at the office, store all sample buckets in a safe place to await processing. Ensure that all field forms are completed and organized. Check your work for legibility and errors in documentation.

Stream Name <i>KENNEDY CREEK</i>			
WRIA # <i>14.0012</i>	Seg # <i>2</i>	<i>0</i>	
RC/T # <i>4</i>	Date: <i>9/15/98</i>	2 Bucket Sample	
Sample # <i>7</i>	Crew Names <i>Allen Pleus</i>	Affiliation <i>TFW-MP</i>	
Bucket # <i>52</i>	<i>DEVIN SMITH</i>	<i>TFW-MP</i>	

TFW MONITORING PROGRAM
 6730 MARTIN WAY E.
 OLYMPIA, WA 98516
 (360)438-1180

Figure 26. Example of a completed sample tracking slip copied on waterproof paper that is inserted into the sample bucket. The back of the slip can have contact information copied on it.

5. Sample Processing

Processing uses sieves with mesh sizes in a geometric progression to sort each spawning gravel sample into size classes required for analysis of composition factors such as percent fine sediments. Sorting is the process of using shaking and gravity to allow smaller particles to move downward through the sieve stack until they are retained on a sieve corresponding to their proper particle size class. This section provides the tasks and procedures for processing samples using either the volumetric or gravimetric method.

5.1 Option 1: Volumetric Processing Method

The volumetric processing method uses water to help sort each spawning gravel sample through a series of sieves and then measures the amount of material collected on each sieve as displaced water volume. The volumetric method is divided into Pre-Volumetric Sieve Processing Tasks, Volumetric Sieve Processing Method, Pre-Volumetric Measurement Tasks, Volumetric Measurement Method, and Post-Volumetric Processing Tasks.

5.1.1 Pre-Volumetric Sieve Processing Tasks

Gather, prepare, and record all necessary survey equipment and materials required by crews to complete the volumetric sieve processing procedure.

Volumetric Sieve Processing Equipment

Sieve processing equipment are those items necessary for crews to divide spawning gravel samples into size classes for volumetric measurement. The TFW-MP database is designed to use metric units.

The volumetric sieve processing station is composed of a stable platform that supports a series of large stainless steel funnels (Figure 27). The top funnel is the sieve holder and it rests upon a metal stand that also supports the catch basin. Underneath the platform, a valve is attached to the base of the catch basin. The lab should provide protection from the weather, but must be capable of handling water on the floor. An enclosed room

Sieve Processing Equipment

- ◆ Sieve Processing Station
- ◆ Sieves- 12" diameter- one each of the following sizes:
 - 63.0 mm
 - 31.5 mm
 - 16.0 mm
 - 8.0 mm
 - 4.0 mm
 - 2.0 mm
 - 1.0 mm
 - 0.85 mm
 - 0.5 mm
 - 0.25 mm
 - 0.125 mm
- ◆ Modified graduated cylinders (3)
- ◆ Hose connected to pressurized water supply
- ◆ Nozzle w/volume adjustment
- ◆ Standard Screwdriver
- ◆ Rain gear

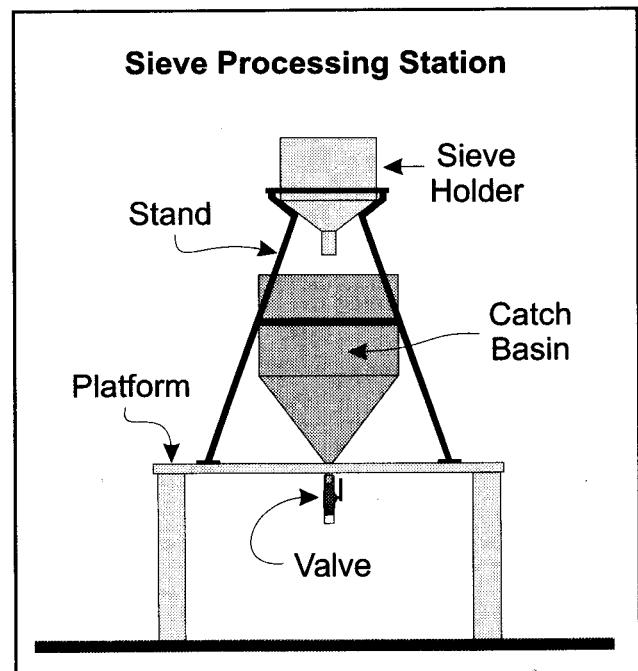

Figure 27. Standard components of the volumetric sieve processing station.

with heat, electricity, a water faucet and a concrete floor with a drain is ideal for volumetric processing in all weather and temperature conditions.

The recommended sieves provide a geometric progression of sizes for characterizing the overall particle size-distribution of the sample. In addition, a 0.85 millimeter sieve is included in the series for calculating percent fine sediment. In some cases, cooperators may not have all of the suggested sieves, or may have a set with somewhat different sizes. At a minimum, the sieve stack should contain eight sieves including the 0.85 millimeter with four sieves larger and three sieves smaller at geometrically spaced intervals.

Check all measurement equipment for damage and calibrate to document accuracy. The use of metric measurement equipment complies with standard scientific methods and the TFW Monitoring Program database.

Volumetric Sieve Processing Materials

Sieve processing materials are those items necessary for crews to cross-check sample information and document sample processing measurements.

- Volumetric Sieve Processing Materials*

 - ◆ Completed "SAMPLE COLLECTION" Form 6.2s
 - ◆ Form 6.3 Copy master (Appendix A)

Form 6.3 "SAMPLE PROCESSING"

Use the copy master to make one copy on regular white paper for office files (Figure 28). Record the *Stream Name/WRIA #/Segment #/Sub-Segment Code* as documented on Form 6.0. Record the initials of the crew lead and recorder in the spaces provided in the upper right-hand corner. Mark the "Volumetric (ml)" circle to identify that the volumetric processing method was used and that measurements are recorded in milliliter units. Leave the "Page ___ of ___" and "Date" fields blank as they must be recorded as the sheet is used during processing.

Record the sieve sizes (in descending order) in the column on the left hand side of the form. Include a row for

Figure 28. SG Comp Survey "Sample Processing" Form 6.3.

the material captured in the modified graduated cylinder attached to the bottom of the catch basin. Label this row as less than the smallest sieve size (e.g., <0.125). Use this copy to make multiple field copies on waterproof paper such as "Rite in the Rain" brand. This process eliminates the need to fill out all header information on each form. Copies can be made single-sided or duplex. Two pages per segment is common.

5.1.2 *Volumetric Sieve Processing Procedure*

There are seven basic steps to the sieve processing procedure. These are: 1) Sieve processing preparation; 2) Sample preparation and tracking; 3) Sample transfer; 4) Sort, rinse, and dry top sieve; 5) Set the 15 minute timer; 6) Sort, rinse, and dry each subsequent sieve; and 7) Set the 20 minute timer.

Step 1. Sieve processing station preparation.

Clean, rinse, and check the catch basin and sieve holder and place them in the stand. Clean, rinse, and check the valve and attach it to the catch basin. Close the valve. Clean, rinse, and check each sieve for loose or stuck sediment particles. Stack the sieves one on top of another in order of descending mesh size, so that the one with the largest mesh size is on the top and the one with the smallest mesh size is on the bottom. Place the tightly nested stack of sieves in the sieve holder. It is important to have the sieves in perfect descending order, otherwise the material will not be properly sorted and the sieve that is out of order will become clogged.

Clean, rinse, and check a modified graduated cylinder and attach it to the valve under the platform. Open the valve. Make sure the rubber hose connecting the modified cylinder is not twisted or pinched. The station is now ready for processing a new sample

Step 2. Sample preparation and tracking.

Clean, rinse, and check the outside of the selected sample storage bucket while it is still sealed. Remove the lid using a lid puller and remove the sample tracking slip. Cross-check the data on the slip with its corresponding SAMPLE COLLECTION field Form 6.2 to verify that the sample is from the same stream and segment. Switch to the SAMPLE PROCESSING Form 6.3 and record the riffle crest or patch number and sample number in the next available column. Fill-in the "X-Check" circle at the bottom of the column to document sample tracking is completed.

Step 3. Sample transfer.

Transfer the sample contents from the storage bucket into the top sieve on the processing station (Figure 29). In most situations, dividing the sample into two buckets is recommended for safety and lifting comfort purposes. Pour the water from the sample bucket into a clean station bucket. Pour the station bucket contents into the top sieve. Adjust the water nozzle for moderate pressure. Clean, rinse, and check the bucket for complete sample removal before setting aside. Next, pour the sample bucket contents into the top sieve. Clean, rinse, and check this bucket also before setting it aside. Some shaking of the sieve stack may be required to fit the entire sample into the sieve.

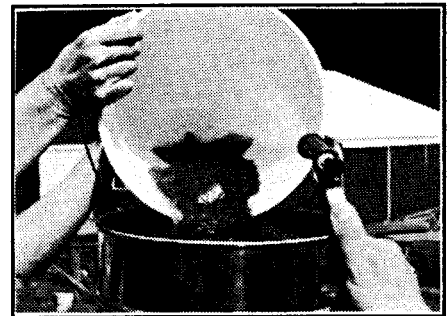

Figure 29. Transfer sample from the storage bucket into the top sieve then clean, rinse, and check it before setting aside.

Step 4. Sort, rinse, and dry top sieve.

General Procedure

Grasp the outside of the top sieve and use a variety of techniques to shake them back and forth (Figure 30). Combine the shaking with water from the nozzle in a downward direction. Wash repeatedly across the particles and around the inside walls of the sieve. Water nozzle pressure and intensity of shaking are adjusted according to the needs of each sieve. Insufficient washing and shaking will require more processing time and may not provide effective sorting for all size classes.

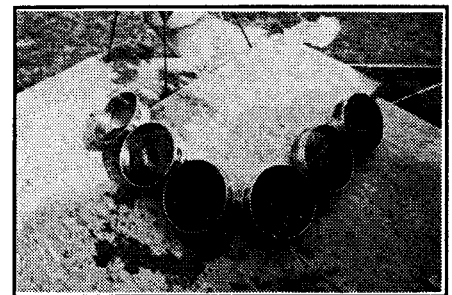
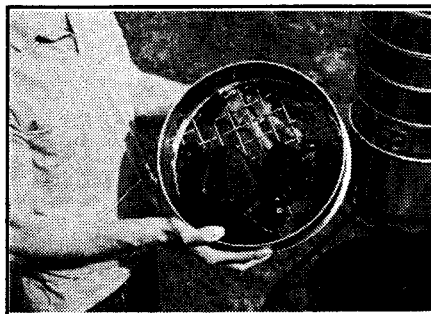

Figure 30. Sort, rinse, and dry top sieve.

Overaggressive washing and shaking can cause particles to be lost out the top of the sieve, eventual overfilling of the catch basin, and unseating of the sieve stack. This can result in a complete loss of the sample.

Technique for sorting sieve sizes of 31.5 millimeters and larger

On these size sieves, the basic washing and shaking action is supplemented with a hand sorting technique. Select particles that are suspected to be of a smaller size class and manually test them to see if their B-axis can pass through a mesh opening in the sieve. The B-axis is the standard dimension for determining a particle's size class. One minute per sieve is common for sorting this size class.

When the top sieve is fully sorted, lift it just off the stack. Tilt the sieve so that the lowest edge is over the top of the next sieve. Adjust the nozzle and gently rinse the sieve bottom so that clinging particles held by surface tension are transferred into the next sieve. A standard screwdriver is used to dislodge stuck sieves. Remove the sieve from the station to the drying area and gently place it at an angle to dry.

Step 5. Set the 15 minute timer.

Once the first sieve has been placed to dry, a timer is set for 15 minutes. This timer provides a minimum standard drying time for the sieves. It is important to allow time for water to drain from the spaces between the particles because water mixed with the particles will create additional displacement, resulting in an overly high volume measurement. Some inaccuracy is unavoidable because water will be held between the smaller particles by capillary action.

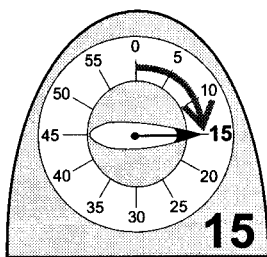

Step 6. Sort, rinse, and dry each subsequent sieve.

General Procedure

Grasp the outside of the top sieve and use a variety of techniques to shake them back and forth. Combine the shaking with water from the nozzle in a downward di-

rection. Wash repeatedly across the particles and around the inside walls of the sieve. Water nozzle pressure and intensity of shaking are adjusted according to the needs of each sieve. Additional sorting techniques can be applied based on size ranges of sieves.

Technique for sorting sieve sizes of 2.0 to 16.0 millimeters

As one crew takes the sorted sieve to the drying area, the other proceeds with sorting the next sieve. On these size sieves, sorting effort varies with quantity of particles at similar size classes and the amount of finer sediments required to pass through. One to two minutes per sieve is common for sorting these size classes. More particles mean more time is needed to allow all particles to come in contact with the screen and have an opportunity to pass through. Indicators of a fully sorted sieve include consistency in particle size, colors, and textures. Another indicator is clear water draining out the bottom of the sieve.

Technique for sorting sieve sizes less than 1.0 millimeters

On these size sieves, the smaller particles tend to clump together. This is a result of similar size particles being held by the surface tension of the water. Alternate between overall rinses and focusing on spraying into the clump. Keep the water nozzle just above the particles and use a circular wash pattern. Be careful of water pressure as this size particle is the most susceptible to being driven out the top of the sieve. Finish by working the clump of particles into a limited area of the sieve for more effective removal later. One to three minutes per sieve is common for sorting these size classes.

Use an adequate amount of water during processing to ensure good results. However, there is a limit to the amount of water that can be held by the catch basin without causing an overflow. Monitor the water level in the catch basin to avoid overflowing it. If the catch basin overflows and suspended fine sediments are lost, document the problem and note the estimated pan sediment bias.

Step 7. Set the 20 minute timer.

Immediately after the last sieve is taken off and placed to dry, the second timer is set for 20 minutes. This timer allows a standard amount of time for the smallest sediments to settle out of the catch basin and into the modified cylinder. The 20 minute timer will ring sometime during the volumetric measurement section of the processing.

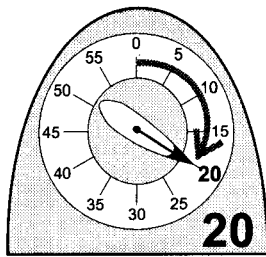

The particle size class captured in the modified cylinder is called "pan sediments." These are the clay and silt particles fine enough to pass through the smallest sieve. In order to ensure consistent results, adequate time must be provided for sediment to settle into the graduated cylinder. Use this time to begin volumetric measurement of the sieve contents.

5.1.3 Pre-Volumetric Measurement Tasks

Gather, prepare, and record all necessary equipment required by crews to complete the volumetric measurement procedure. The use of metric measurement equipment complies with standard scientific methods and the TFW Monitoring Program database.

Volumetric Measurement Equipment

- ◆ Sturdy table
- ◆ Displacement flask, with rubber tubing on outlet and clip to control flow
- ◆ Graduated cylinder- 1000 ml
- ◆ Graduated cylinder- 500 ml
- ◆ Graduated cylinder- 100 ml
- ◆ Pick or awl
- ◆ Brass wire brushes (1 med/1 small)
- ◆ Nylon brushes (1 med/1 small)
- ◆ Turkey baster or small cup
- ◆ Timers (3)
- ◆ Towel
- ◆ Clamp or light with extension cord
- ◆ Level

Setting Up the Volumetric Measurement Station

The volumetric station is composed of a level table that supports a stainless steel displacement flask, graduated cylinders, and other tools used to transfer sieve contents and measure displaced water volumes. The flask is designed to hold an entire gravel sample without adding more water or removing sediment. The station must be protected from the weather, but must be capable of handling water. An enclosed room with heat, electricity, a water faucet and a sink or floor drain is ideal for processing.

A dry workstation is essential to prevent external water from biasing measurements. This is because the unit of measure changes during the next processing stage from sediment volume to water volume. The basic principle followed is that the volume of a particle displaces the exact same volume of water within a container. In volumetric processing, the displacement flask is used to capture and funnel the displaced water into a graduated cylinder for measurement (Figure 31). A "Law of Fives" technique is applied during this process as a standard procedure for leaving a consistent amount of residual water or sediment on measurement equipment. It was developed by Jeff Cederholm of the Washington Department of Natural Resources.

The displacement flask catch basin can be pre-marked for quick reference to displaced volume and cylinder selection before volumetric measurement begins. This procedure first requires conducting steps 1 and 3 below. Next, in the zeroed-out flask add 100 milliliters of water and mark the waterline with a permanent marker. Add 400 milliliters more water to the flask and mark the new waterline. Add 500 milliliters more water and mark the waterline. This process identifies the 100, 500, and 1000 milliliter displaced volume waterlines. Additional water can be added to identify greater volumes.

5.1.4 Volumetric Measurement Procedure

After the 15 minute timer rings, the contents of each sieve are removed and measured in the same order that they were sorted during sieve processing. A systematic volumetric measurement process helps to eliminate

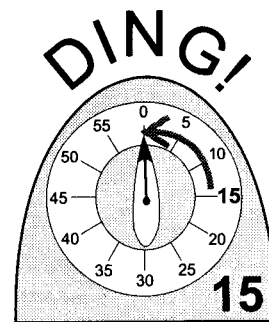

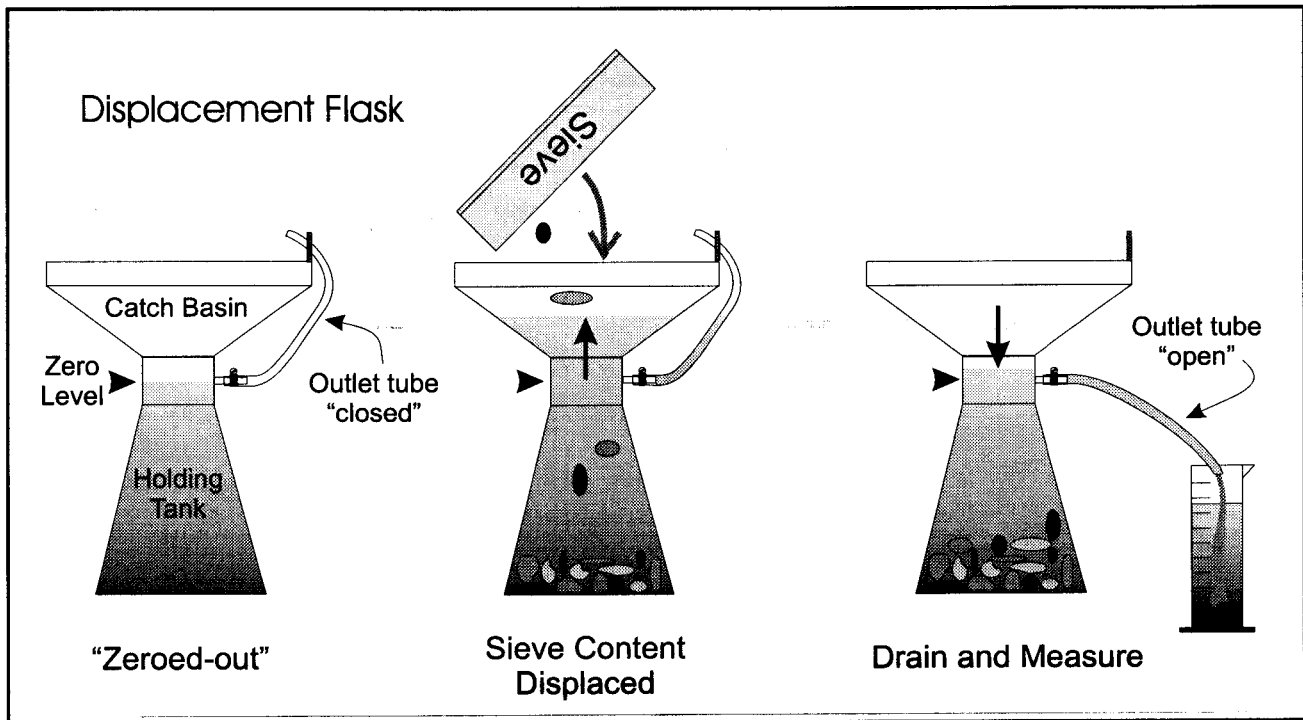

Figure 31. General concept for volumetric measurement using a "zeroed-out" displacement flask, adding sieve contents, and measuring the displaced volume of water.

errors and ensure that each sieve drains for a similar amount of time.

There are seven basic steps to the sieve processing procedure. These are: 1) Volumetric measurement station preparation; 2) Cross-check sample documentation; 3) Zero-out displacement flask; 4) Sample transfer from sieve to flask; 5) Select graduated cylinder; 6) Measure displaced water; 7) Record volume measurement; 8) 20 minute timer; and 9) 60 minute timer.

Step 1. Volumetric measurement station preparation.

Clean, rinse, and check the displacement flask for damage and contamination from sediment, vegetation, or other debris. Set the flask on a support platform to stabilize. Orientation marks are made on the flask and support platform and these must remain lined up throughout the processing. Check the outlet tube for defects and loose connections and secure it in the "closed" position. Fill the flask with water until the level is well over the outlet. Rinse each graduated cylinder and shake 5 times.

Step 2. Cross-check sample documentation.

Check and make sure the riffle crest or patch number and the sample number are recorded on the data form (circle appropriate type).

Step 3. Zero-out displacement flask.

Release the outlet tube and let the excess water in the flask drain out. When the flow stops or reaches a consistent slow drip, tap the end of the outlet tube 5 times and secure it in the closed position.

Step 4. Sample transfer from sieve to flask.

General Procedure

Use the "tap, check, and dislodge" technique to transfer the contents of the first sieve into the displacement flask (Figure 32). Hold the sieve over the displacement flask and carefully pour the particles out of the sieve into the displacement flask, taking care not to splash water out. Larger particles can be picked out and placed by hand into the flask. Next, firmly tap the upside-down

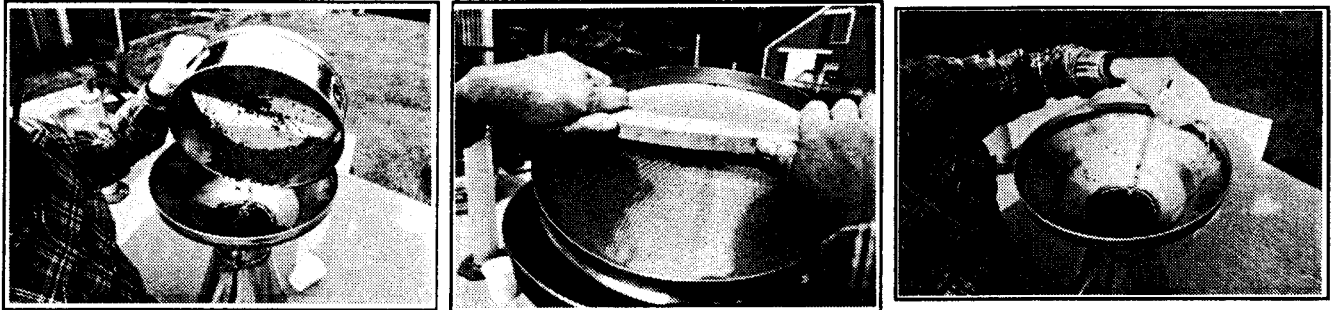

Figure 32. General procedure for transferring material from the sieve into the catch basin of the flask using the "tap, check, and dislodge" technique and finishing by rinsing clinging particles from the catch basin into the holding tank.

sieve 5 times into the flask's catch basin. Check the sieve for stuck particles by holding it in front of a good light source so that the mesh openings are clearly visible. Dislodge stuck particles using tools appropriate for the sieve's mesh size. Repeat the tap, check, and dislodge technique as needed until the entire mesh is free of stuck particles.

Next, check the inside rim of the sieve and rinse residual clinging particles into the flask with a turkey baster and water from the flask. When the entire sieve is clean, tap the turkey baster and the sieve 5 times into the flask. Complete the content removal by rinsing residual clinging particles in the flask's catch basin into the holding tank. Tap the turkey baster 5 more times into the flask and set aside. The displaced water is now ready to be measured.

Technique for sieve sizes of 2.0 millimeter and greater

On these size sieves, an awl and a medium size brass wire brush are the most effective tools for dislodging stuck particles. Be thorough and make sure all particles are removed from sieve meshes.

Technique for sieve sizes of 1.0 millimeters and less

On these size sieves, the brass wire brush is the principal tool used as the awl may damage the more delicate mesh wires. Firm pressure and slow strokes provide the most effective and stable cleaning action. Be sure to run the edge of the brush around the inside rim of the sieve. The nylon brush is used on the 0.125 millimeter sieve to prevent damage to the mesh. Start on one end and use a variety of brushing strokes to cover the entire mesh surface. Some residual sediment stuck in the sieve mesh is expected.

Step 5. Select graduated cylinder.

Select the smallest graduated cylinder that will hold the entire displaced volume at one time. This requires experience to judge unless the flask has been pre-marked. In situations where water levels indicate displaced volumes exceeding 1000 milliliters, two or more cylinders will be required. Start with the 1000 milliliter cylinder.

The displacement flask catch basin can be pre-marked for quick reference to displaced volume and cylinder selection before processing begins. Zero-out the flask and close the outlet tube. Add 100 milliliters of water to the flask and mark the waterline with a permanent marker. Add 400 milliliters more water to the flask and mark the new waterline. Add 500 milliliters more water and mark the waterline. This process identifies the 100, 500, and 1000 milliliter displace volume waterlines. Additional water can be added to identify greater volumes.

Step 6. Measure displaced water.

After the water in the flask has become still, release the outlet tube and carefully lower the tip of the tube and the cylinder together until the water is flowing freely into the cylinder (Figure 33). When the flow stops or reaches a consistent slow drip rhythm, tap the end of the outlet tube 5 times into the cylinder. Secure the outlet tube in the closed position on the displacement flask. This procedure automatically re-calibrates the flask back to zero for the next sieve measurement.

In situations where displace volumes are greater than

Salmonid Spawning Gravel Composition Survey

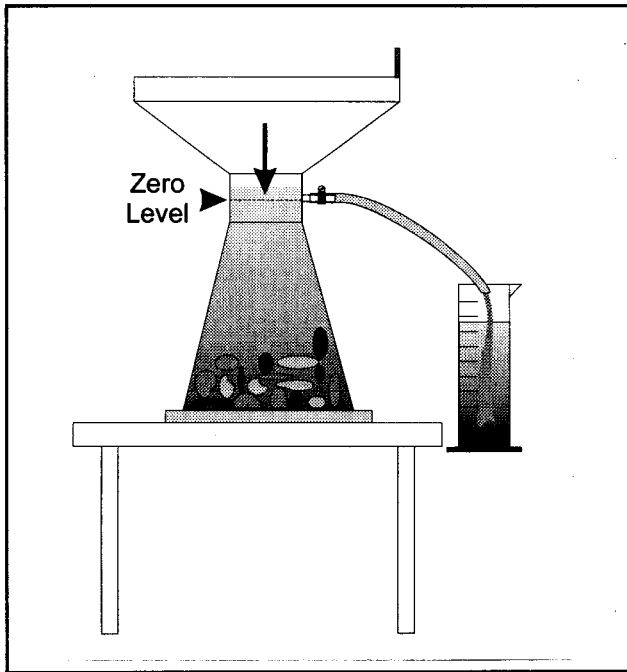

Figure 33. Release the outlet tube and drain the excess water into the selected graduated cylinder.

1000 milliliters or when proper cylinder size was not selected, multiple graduated cylinders are required to measure total displace volume. Stop the water flow before it reaches the highest measurement mark on the cylinder by lifting the tube and cylinder up past the waterline in the flask. Set the first cylinder on the table and select the next graduated cylinder based on the remaining volume in the flask. Repeat the measurement procedure.

Water loss through spilling or splashing biases the measurement and must be recorded. Excessive water loss may require reprocessing or discarding the entire sample.

Step 7. Record volume measurement.

Hold the graduated cylinder vertically level and read the measurement corresponding to the water level (Figure 34). A good light source behind the cylinder helps in this process. Where a meniscus is evident, consistently read either the bottom or the top for all samples in the segment. Use of wire handles or a two finger technique at the top of the cylinder allows the cylinder to find a natural level. The bases on the graduated cylinders cannot be trusted for consistent leveling due to damage, warping, and comparability to other gradu-

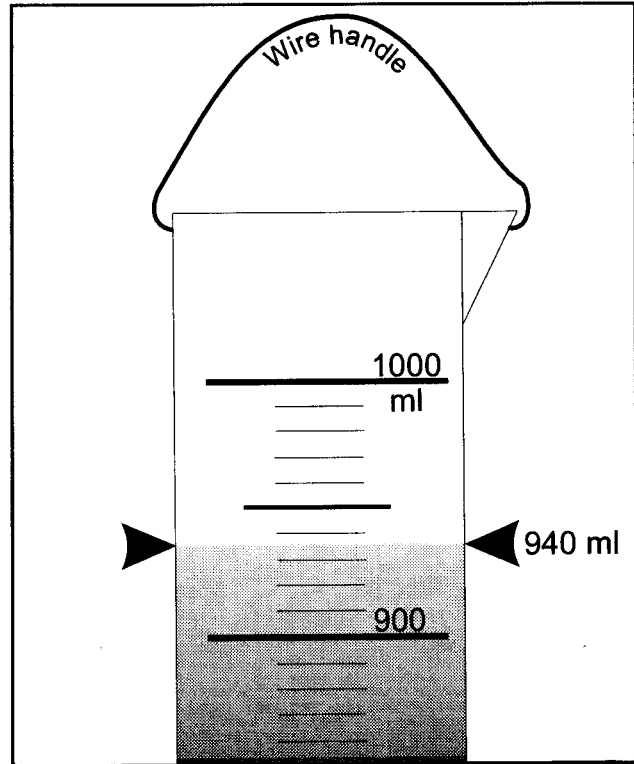

Figure 34. Read the volume corresponding to the water line and round to the nearest measurement mark for that graduated cylinder.

ated cylinders. Measurements are rounded to the nearest measurement mark based on the accuracy of the cylinder. 1000 milliliter cylinders are generally accurate to the nearest 10 ml, 500 ml cylinders to the nearest 5 ml, and 100 ml cylinders to the nearest 1 ml.

Record the measurement on Form 6.3 corresponding to RC/P# and sieve size. Add any notes related to sample processing quality. Where multiple graduated cylinders are used, record all measurements with a plus sign in between (e.g., "940 + 245"). Discard the cylinder water only *after* the measurement has been recorded. Shake the cylinder 5 times.

Step 8. 20 minute timer.

Sometime during the volumetric measurement process, the 20 minute timer will ring. Return to the sieve processing station and close the valve. Carefully remove the modified cylinder. Once re-

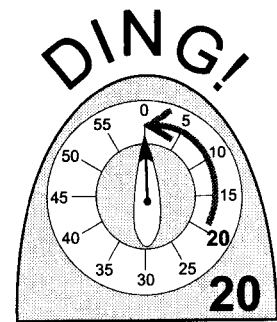

moved, the valve is reopened to drain the remaining water in the catch basin. Gently set the modified cylinder aside in a secure and stable location. Place the appropriate sample tracking slip under the cylinder's base. Set the third timer for 60 minutes.

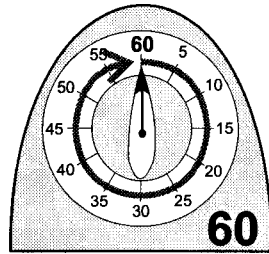

Step 9. 60 minute timer.

The 60 minute timer will ring sometime during the next sample processing cycle. When this happens, collect the cylinder and read the volume based on the sediment line level. This measurement is recorded in the proper sample number column on the "<1.25" millimeter row. The entire volumetric measurement process is now complete for that sample.

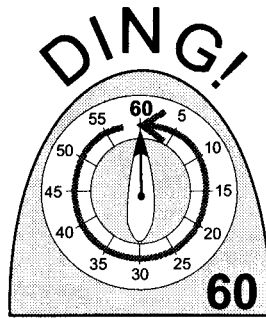

5.1.5 Post-Volumetric Processing Tasks

At the end of the sample processing, mark the blank column after the last sample record "END OF PROCESSING" for documentation. Clean and store all processing equipment. Back at the office, check to make sure that all field forms are completed and organized. Check documentation for legibility and errors.

5.2 Option 2: Gravimetric Processing Method

The gravimetric processing method uses a dry sieve sorting procedure to divide each spawning gravel sample. The weight of material collected on each sieve is measured in gram units. The gravimetric method is divided into Pre-Gravimetric Processing Tasks, Gravimetric Processing Method, and Post-Gravimetric Processing Tasks.

5.2.1 Pre-Gravimetric Processing Tasks

Gather, prepare, and record all necessary survey equipment and materials required by crews to complete the

gravimetric processing procedure.

Gravimetric Equipment

Sieve processing equipment are those items necessary for crews to divide spawning gravel samples into size classes for gravimetric measurement. The TFW-MP database is designed to use metric units.

Gravimetric Sieve Processing Equipment

- ◆ Drying oven (Gilson BO-550). Note: Many options available. Regular domestic ovens will also work.
- ◆ Sieves- 12" diameter- one each of the following sizes:
 - 63.0 mm
 - 31.5 mm
 - 16.0 mm
 - 8.0 mm
 - 4.0 mm
 - 2.0 mm
 - 1.0 mm
 - 0.85 mm
 - 0.50 mm
 - 0.25 mm
 - 0.125 mm
- ◆ Mechanical shaker
- ◆ Sample splitter
- ◆ Filter masks

Sample Measurement Equipment

- ◆ Triple beam or electronic balance (20 kg capacity)
- ◆ (6) Drying pans (stainless steel, 52.5 x 32.2 x 10.1 cm)
- ◆ (11) Weighing pans (34.29 cm diameter, 8.9 cm height)

Lab requirements for gravimetric processing are similar to those for the volumetric method. A dry, dust-resistant room, with a concrete floor, good lighting and ample electrical outlets is necessary. Because the shaking process is noisy, try to locate the lab away from other co-workers. A sturdy table to place the balance and record data is also nice. It is recommended that the mechanical shaker be bolted to a secure base, as vibration and movement of the unit can be significant.

Gravimetric Materials

Materials are those items necessary for crews to cross-check sample information and document sample processing measurements.

Gravimetric Processing Materials

- ◆ Completed "SAMPLE COLLECTION" Form 6.2s
- ◆ Form 6.3 Copy master (Appendix A)

Form 6.3 "SAMPLE PROCESSING"

Use the copy master to make one copy on regular white paper for office files. Record the *Stream Name/WRIA #/Segment #/Sub-Segment Code* as documented on Form 6.0. Record the initials of the crew lead and recorder in the spaces provided in the upper right-hand corner. Mark the "Gravimetric (gm)" circle to identify that the gravimetric processing method was used and that measurements are recorded in gram units. Leave the "Page ___ of ___" and "Date" fields blank as they must be recorded as the sheet is used during processing.

Record the sieve sizes (in descending order) in the column on the left hand side of the form. Include a row for the material captured in the modified graduated cylinder attached to the bottom of the catch basin. Label this row as less than the smallest sieve size (e.g., <0.125). Use this copy to make multiple field copies on waterproof paper such as "Rite in the Rain" brand. This process eliminates the need to fill out all header information on each form. Copies can be made single-sided or duplex. Two pages per segment is common.

5.2.2 Gravimetric Processing Procedure

Field collected samples (previously stored in individual, labeled 5-gallon buckets) must be dried prior to processing. Sample buckets should be left undisturbed for 48 hours to allow the suspended fraction to drop out. Carefully open the lids of the sample buckets to be processed. Inspect the volume of water in each gravel sample. If there is significant water in your sample, carefully siphon or pump away excess supernatant (clear water) to within five cm of the gravel layer.

Place samples in individual drying trays making sure that the bucket is cleaned of remaining sediment particles. Be sure to include the metal identification tag as well. Drying trays should be large enough to contain one entire McNeil sample. Oven dry each sample for 12-24 hours at between 50-105 degrees centigrade. Experience will dictate the time and temperature setting for efficient processing of your samples. If you are sampling in geologies dominated by clay, use a lower temperature setting, as some researchers have reported fracturing of gravel and rubble particles.

Once your samples have been dried and cooled, they can be sieved. Check to see that the sieves are in descending order. Place them into the shaker frame, and add the gravel sample to the sieve stack. Place the shaker lid over the largest sieve, then adjust and tighten the adjustment bolts and set the shaker timer for five minutes. In clay geologies a longer shaking time may be necessary. If using the recommended Phi-series of sieves it will be necessary to shake each sample through 11 sieves. Because standard shakers hold only 6 sieves, the investigator must shake the sample through the larger 5 sieves, then again through the final 6 small sieves. Once the samples have been shaken, remove each size sieve and place the sample portion into individual weighing pans.

As sieve size decreases, the sieves will become increasingly "clogged" with sediment. Be sure to thoroughly clean each sieve with the appropriate brush. It is a good idea to pre-mark each weighing pan to a corresponding size class and to clearly mark the tare weight of the pan. Samples can then be weighed on the balance. The total weight of the sample/pan minus the tare weight equals the sample weight. Record the weight of material in each sieve on Form 6.3.

5.2.3 Post-Gravimetric Processing Tasks

At the end of the sample processing, mark the blank column after the last sample record "END OF PROCESSING" for documentation. Clean and store all processing equipment. Back at the office, check to make sure that all field forms are completed and organized. Check documentation for legibility and errors.

6. Survey Documentation

After completion of the field portion of the SG Comp Survey, field forms need to be organized, supplemental information and calculations completed, and all forms and information error checked before the data is ready to be entered into the database. The objective of this section is to organize the data to ensure that this survey can be repeated the same way in the future by different crews. Refer to Appendix B for examples of completed forms.

6.1 Finalizing Field Forms

All Forms

◆ Page numbering is related to form type. Count the number of total pages separately for Forms 6.0, 6.1R or 6.1P, 6.2, and 6.3.

◆ The page number should be filled in as used during the survey (e.g., Page 1 of __, Page 2 of __, Page 3 of __, etc.). Forms that have been copied on both sides of one sheet of paper will count as two separate pages.

◆ The total number of pages for each type of form is filled in at the end of the survey (e.g., Page 1 of 6, Page 2 of 6, Page 3 of 6, etc.).

◆ Organize the field forms by type and then by page number for easy reference. It is common to have different totals for each type.

Form 6.0

◆ *Study Design Information:*

Survey Length: Record the total sample and non-sample reach inventoried for sample collection. Refer to Sample Inventory Form 6.1R or 6.1P "Distance" column for the actual or calculated measurement.

Survey Coverage: Fill-in the survey's coverage circle and percentage of the survey length that best applies to the survey. Mark "WHL" if the whole or entire segment or sub-segment was inventoried for sample collection (100%). Mark "PRT" if the survey was applied on a consecutive length of a partial segment/sub-seg-

ment. For example, where only the first 500 meters of a 2,000-meter-length segment will be inventoried for sample collection (25%). Mark "SUB" if the survey was applied using a random or systematic placement sub-sampling strategy. For example, where every other 100 meter interval reach will be inventoried for sample collection (50%). Mark "PSB" if a combination of PRT and SUB was applied. Mark "OTH" if your study design differs from the above.

Partial/Other Survey Location: These locations are associated with survey length lower and upper boundaries - that is, the section of stream inventoried for sample collection. *WRIA River Mile:* Record the WRIA river/stream mile locations to the nearest tenth of a mile (0.0 - 9999.9). *Reference Points:* Record the reference point numbers (0 - 9999).

Sample Method: Fill-in the circle corresponding to the type sample method applied.

Sample Processing: Fill-in the circle corresponding to the type sample processing applied.

◆ *Sample Inventory:* Record the beginning and ending dates of sample inventory as noted on Form 6.1. Record the results of the inventory and the sub-sample population identification strategy including: total number of inventoried riffle crests/patch transects; sub-sample percent from Table 3; random number selected based on Table 3; riffle crest/patch transect sites identified from Table 4 plus additional sites if needed; and the resulting estimated number of samples.

◆ *Sample Collection:* Record the beginning and ending dates of sample collection as noted on Form 6.2. Record the results of the sample collection including the actual riffle crest/patch transect sites where samples were collected, and the resulting number of samples collected using those sites.

◆ *Sample Processing:* Record the beginning and ending dates of sample processing as noted on Form 6.3 and the actual number of samples processed.

◆ *Survey Notes:* This section is provided to make brief notes related to unique survey conditions and problems encountered. Additional information can be included on the back of the form or on separate sheets of paper. If separate sheets are used, they need to be included in the "Page ___ of ___" information and have the key header information listed at the top of each page.

6.2 Error Checking

Error checking of field forms is a very important task and sufficient time should be taken to complete it. It is best done during or immediately after data collection. It becomes more difficult to reconcile discrepancies and track down correct information the more time passes since the survey was completed. Where information cannot be corrected, the data may not be useful for monitoring purposes. Contact the TFW-MP for assistance in determining how to handle missing data fields.

Review Forms 6.0, 6.1R, 6.1P, 6.2, and 6.3 plus all other documents compiled during the SG Comp Survey. Have a second person look them over for completeness, legibility and errors. Every page of every form requires error checking for legibility, complete and consistent header information, obvious measurement and transcription errors, and calculation errors. Work systematically through each section and when completed, put your initials and date in the "Error Checked by" box at the bottom of each page. If the person error checking the data is not a crew member, their full name and task should be recorded in the "Survey Summary Field Notes" section of Form 6.0.

7. Data Management

The TFW Monitoring Program offers data management services to help cooperators quickly analyze data collected with the program's methods and to produce standard monitoring reports. The heart of the service is a database system housed at the Northwest Indian Fisheries Commission. This database is available to do calculations, produce reports and archive electronic versions of the data. The database is also an important archive of monitoring data that can be used for developing study designs and identifying control or reference sites.

7.1 Data Preparation

Before data entry can occur for the SG Comp Survey, some preparation must be done. The following materials are needed:

- ◆ completed and error-checked Forms 6.0 and 6.3 as needed for each segment,
- ◆ a data entry system;
- ◆ a set of data entry system instructions; and
- ◆ an "Ambsys" data dictionary
- ◆ copy of completed Stream Segment Identification Form 1.0
- ◆ copy of completed Reference Point Survey Form 2.0

Before the data entry process can begin, an entry system must be selected. Choose a data entry system from the list below and request a free copy from the TFW Monitoring Program. The database has three entry system options for survey data. These are:

- ◆ Microsoft Excel 4.0 pre-formatted spreadsheets;
- ◆ Lotus 1-2-3 (vers. 3) pre-formatted spreadsheets; and
- ◆ Microsoft Access 7.0 pre-formatted entry forms

Refer to Appendix E for an example of the Excel pre-formatted spreadsheet. Select a spreadsheet format if your data requires conversion from English to metric units. Replace all English unit measurements with metric equivalents. Read the instructions for the data entry

system and the Ambsys data dictionary, noting the field types and data constraints (what type of data can be entered into each field).

7.2 Data Processing, Products, and Archiving

Open the section of the entry system pertaining to the SG Comp Survey on your computer. You must complete both the header and sieve sample forms. Following the entry system instructions, key in the data from Forms 6.0 and 6.3 as directed. After you have completed keying in the data and saved the session, have another person compare the data recorded on the original field forms to the corresponding data on the screen. Save the file a final time once the accuracy of the entered data is verified.

Data can be sent to the TFW Monitoring Program using several different methods. A few are described here. Gather together: a) copies of the field forms; b) USGS topographic maps with the stream segment locations marked; and c) the floppy disk with the electronic version of the data. This package can be delivered in person to the Northwest Indian Fisheries Commission, or sent through the mail. The electronic versions can be sent via e-mail, and hard copies can be faxed. After the program receives the electronic files, the data is imported into the database by a TFW-MP staff person. Safe and efficient archiving is also provided through Data Management Services. The data generated by individual cooperators is archived electronically in the database system. Hard copies of the field forms, topographic maps and supplemental information can also be archived at the TFW-MP facility to meet quality assurance needs and to reduce the chance of loss due to personnel changes or destruction. Access to cooperator data can be limited by request.

7.3 Data Analysis

Spawning gravel composition has been characterized in a variety of ways by different investigators. Young et al. (1991) evaluated 15 different measures of substrate composition. They determined that geometric mean diameter (Dg) was the most sensitive measure of

survival to emergence and the percentage of particles less than 0.85 millimeter (mm) was the most sensitive indicator of changes to substrate induced by land management activities. They concluded that no single measure would be adequate to describe both potential survival to emergence and alteration of substrate due to land management activities.

Consequently, substrate samples will be analyzed using both measures. The percentage of particles less than 0.85 mm (volumetric equivalent) will be calculated for each individual sample and the segment average will be provided for use in Watershed Analysis. The geometric mean diameter (gravimetric equivalent) of the particles per sample will also be provided.

The results of the data analysis are available in three reports: the Spawning Gravel Composition Segment Report; the Spawning Gravel Composition Sampling Site Report; and the Spawning Gravel Composition Individual Sample Report. Refer to Appendix E for examples of these reports.

7.3.1 Spawning Gravel Composition Segment Report

This report contains the results of data analysis on the stream segment scale and is divided into Segment Data Summary and Individual Sample Summary sections. The Segment Data Summary section includes: number of samples in segment; Watershed Analysis rating for the segment; segment mean and standard deviation of the percentage of particles less than 0.85 mm (volumetric) and the geometric mean diameter (gravimetric); and the percentage of samples for each Watershed Analysis rating category. The Individual Sample Summary section includes: sample site and sample number; percent particles less than 0.85 mm; Watershed Analysis rating; and geometric mean diameter.

The Watershed Analysis rating categories are based on the percentage of particles less than 0.85 mm (fine sediments) and includes: samples with less than 12% fine sediment (GOOD), samples with 12-17% fine sediment (FAIR), and samples with greater than 17% fine sediment (POOR).

Information on the amount of material retained on each sieve will have been recorded in either grams or milliliters depending on the processing method used. This

information will be entered into the database and a conversion factor will be used to calculate equivalent gravimetric values for volumetric data or volumetric equivalents for gravimetric data.

The percentage of fine sediments less than 0.85 mm will be calculated by summing the total amount of material in the size classes less than 0.85 mm and dividing by the total amount of material in the sample. The average value for percentage of fine sediments less than 0.85 mm is calculated by summing all the individual sample values for percent of particles less than 0.85 mm and dividing by the total number of samples from the segment. The standard deviation of segment percent particles < 0.85 mm is calculated.

The geometric mean diameter will be calculated with the formula used by Young et al. (1991) from Lotspeich and Everest (1981). The average value for geometric mean diameter is calculated by summing the individual geometric mean diameter values for all the samples in the segment and dividing by the total number of samples. The standard deviation of segment geometric mean diameter is calculated.

7.3.2 Spawning Gravel Composition Sample Site Report

This report contains the results of data analysis on the riffle crest or patch transect scale. Categories of analysis include: percent of total sample sites rated by Watershed Analysis good/fair/poor category; mean percent of particles less than 0.85 mm; standard deviation of percent particles less than 0.85 mm; Watershed Analysis rating by sample site; geometric mean diameter; and standard deviation of geometric mean diameter.

Watershed Analysis ratings, percentage of particles less than 0.85 mm, and geometric mean diameter are calculated as noted in the segment report.

7.3.3 Spawning Gravel Composition Individual Sample Report

This report contains the results of data analysis on each sample and is divided into Individual Sample Summary and Individual Sample Data sections. The Individual Sample Summary section includes: Sample site and

sample number; percentage of particles less than 0.85 mm (volumetric); and geometric mean diameter (gravimetric). The Individual Sample Data section includes: sieve size; weight in grams; volume in milliliters; and cumulative percent finer than in milliliters.

Percentage of particles less than 0.85 mm and geometric mean diameter are calculated as noted in the segment report. The amount of material retained on each sieve expressed both as volume and weight and the cumulative percentage less than the next sieve size will be calculated for each sample taken. The cumulative percent less than the next largest sieve size will be calculated for each sieve size by summing the amount of material on that sieve and all smaller size classes and dividing this figure by the total material in the sample.

8. References

- Adams, J.N. and R.L. Beschta. 1980. Gravel bed composition in Oregon coastal streams. *Can. J. Fish. Aquat. Sci.* 37:1514-1521.
- Alderdice, D.F., W.P. Wickett and J.R. Brett. 1958. Some effects of temporary exposure to low dissolved oxygen levels on Pacific salmon eggs. *J. Fish. Res. Bd. Can.* 15(2):229-249.
- Bams, R.A. and C.N.H. Lam. 1983. Influence of deteriorating water quality on growth and development of chum salmon (*Oncorhynchus keta*) larvae in a Japanese-style keeper channel. *Can. J. Fish. Aquat. Sci.* 40:2098-2104.
- Cederholm, C.J. and L.C. Lestelle. 1974. Observations on the effects of landslide siltation on salmon and trout resources of the Clearwater River, Jefferson County, Washington, 1972-73. Final Rept. FRI-UW-7404. Fish. Res. Inst. Univ. Wash. Seattle.
- Cederholm, C.J., L.M. Reid, and E.O. Salo. 1981. Cumulative effects of logging road sediment on salmonid populations in the Clearwater River, Jefferson County, Washington. p. 38-74 IN: Proceedings of the conference on salmon spawning gravel: a renewable resource in the Pacific Northwest? Wash. Stat. Univ. Pullman.
- Chapman, D.W. 1988. Critical review of variables used to define effects of fines in redds of large salmonids. *Trans. Amer. Fish. Soc.* 117(1):1-21. Jan. 1988.
- Duncan, S.H. and J.W. Ward. 1985. The influence of watershed geology and forest roads on the composition of salmon spawning gravel. *Northwest Science* 59(3):204-212.
- Everest, F.H., R.L. Beschta, J.C. Scrivener, K.V. Koski, J.R. Sedell, and C.J. Cederholm. 1985. Fine sediment and salmonid production: a paradox. p. 98-142 IN: E.O. Salo and T.W. Cundy (eds.). *Streamside management: forestry and fishery interactions*. Cont. No. 57. Coll. of For. Res. Univ. of Wash. Seattle.
- Hicks, B.J., J.D. Hall, P.A. Bisson and J.R. Sedell. 1991. Response of salmonids to habitat changes. p. 483-518 IN: Influences of forest and rangeland management on salmonid fishes and their habitats. *Amer. Fish. Soc. Spec. Publ.* 19.
- Iwamota, R.N., E.O. Salo, M.A. Madej and R.L. McComas. 1978. Sediment and water quality: a review of the literature including a suggested approach for water quality criteria. EPA 910/9-78-048. USEPA. Seattle.
- Johnson, R.A. 1980. Oxygen transport in salmon spawning gravels. *Can. J. Fish. Aquat. Sci.* 37:155-162.
- Koski, K V., 1966. The survival and fitness of coho salmon (*Oncorhynchus kisutch*) from egg deposition to emergence in three Oregon coastal streams. Masters Thesis, OSU, Corvallis. 84 p.
- Koski, K V., 1975. The survival and fitness of two stocks of chum salmon (*Oncorhynchus keta*) from egg deposition to emergence in a controlled stream environment at Big Beef Creek. PhD dissertation. Univ. of Wash. Seattle.
- Lisle, T.E. 1987. Using residual depths to monitor pool depths independently of discharge. Res. Note. PSW-3994. USDA For. Serv. Pac. SW For. Range Exp. Stat. Berkeley.

- Lisle, T.E. 1989. Sediment transport and resulting deposition in spawning gravels, north coastal California. *Wat. Resour. Res.* 25(6):1303-1319. June 1989.
- Lotspeich, F.D. and F.H. Everest. 1981. A new method for reporting and interpreting textural composition of spawning gravel. USDA For. Serv., Research Note PNW-369, Pacific Northwest For. Rng. Exp. Stat. Portland.
- McNeil, W.J. 1969. Survival of pink and chum salmon eggs and alevins. p. 101-117 IN: T.G. Northcote (ed.). Symposium on salmon and trout in stream. H.R. McMillan Lectures in Fisheries. Univ. of British Columbia. Vancouver, B.C.
- McNeil, W.J. and W.H. Ahnell. 1960. Measurement of gravel composition of salmon streambeds. Circ. No. 120. Fish. Res. Inst. Univ. of Wash. Seattle.
- McNeil, W.J. and W.H. Ahnell. 1964. Success of pink salmon spawning relative to size of spawning bed materials. Spec. Rpt.- Fisheries No. 469. US Fish and Wildlife Serv. Washington, D.C.
- McHenry, M L, C M Douglas, and E Currence. 1994. Spawning gravel quality, watershed characteristics, and early life history survival of coho salmon and steelhead in five North Olympic Peninsula watersheds. Lower Elwha S'Klallam Tribe, Fisheries Dept. And Makah Tribe Fisheries Management.
- Peterson, N.P., A. Hendry and T.P. Quinn. 1992. Assessment of cumulative effects on salmonid habitat: some suggested parameters and target values. TFW-CMER. Wash. State Dept. of Nat. Res. Div. For. Reg. Asst. Olympia.
- Platts, W.S., R. Torquemada, M.L. McHenry and C.K. Graham. 1989. Changes in salmon spawning and rearing habitat from increased delivery of fine sediment to the South Fork Salmon River, Idaho. *Trans. Amer. Fish. Soc.* 118:274-283.
- Pleus, A.E., and D. Schuett-Hames. 1998. TFW Monitoring Program methods manual for stream segment identification. Prepared for the Washington State Dept. of Natural Resources under the Timber, Fish, and Wildlife Agreement. TFW-AM9-98-001. DNR #103. May.
- Pleus, A.E., and D. Schuett-Hames. 1998. TFW Monitoring Program methods manual for the reference point survey. Prepared for the Washington State Dept. of Natural Resources under the Timber, Fish, and Wildlife Agreement. TFW-AM9-98-002. DNR #104. May.
- Pleus, A.E., and D. Schuett-Hames. 1998. TFW Monitoring Program methods manual for the Habitat Unit Survey. Prepared for the Washington State Dept. of Natural Resources under the Timber, Fish, and Wildlife Agreement. TFW-AM9-99-003. DNR #105.
- Schuett-Hames, D., A.E. Pleus, and D. Smith. 1998. TFW Monitoring Program methods manual for the Salmonid Spawning Habitat Availability Survey. Prepared for the Washington State Dept. of Natural Resources under the Timber, Fish, and Wildlife Agreement. TFW-AM9-98-001. DNR #103.
- Shepard, B.B., S.A. Leathe, T.M. Weaver and M.D. Enk. 1984. Monitoring levels of fine sediment within tributaries to Flathead Lake and impacts of fine sediment on bull trout recruitment. Proceedings of the Wild Trout III Symposium. Yellowstone Nat. Park. Wy.
- Swanson, F.J., L.E. Benda, S.H. Duncan, G.E. Grant, W.F. Megahan, L.M. Reid and R.R. Ziemer. 1987. Mass failures and other processes of sediment production in Pacific Northwest landscapes, p. 99-38 IN: E.O. Salo and T.W. Cundy (eds.). Streamside management: forestry and fishery interactions. Cont. No. 57. Coll. of For. Res. Univ. of Wash. Seattle.

- Tagart, J.V. 1976. The survival from egg deposition to emergence of coho salmon in the Clearwater River, Jefferson County, Washington. M.S. Thesis. Univ. Wash. Seattle.
- Tripp, D. and V.A. Poulin. 1986. The effects of logging and mass wasting on salmonid habitat in streams on the Queen Charlotte Islands. Land Mngt. Rpt. No. 50.. B.C. Ministry of For. and Lands. Vancouver.
- Vaux, W.G. 1962. Interchange of stream and intragravel water in a salmon spawning riffle. Spec. Sci. Rpt. Fisheries No. 405. USDI Fish and Wildlife Serv. Washington, D.C.
- Young, M.K., W.A. Hubert and T.A. Wesche. 1991. Selection of measures of substrate composition to estimate survival to emergence of salmonids and to detect changes in stream substrates. N. Amer. J. Fish. Mngt. 11:339-346.

9. Appendixes

Appendix A

Form 6.0, 6.1R, 6.1P, 6.2, and 6.3 Copy Masters

Appendix B

Completed Examples of Forms 6.0, 6.1R, 6.1P, 6.2, and 6.3

Appendix C

Standard Field and Vehicle Gear Checklist Copy Master

Appendix D

Sample Tracking Slip Copy Master

Appendix E

Data Management Examples

Appendix F

Random Number Table



Appendix A

Form 6.0, 6.1R, 6.1P, 6.2, and 6.3 Copy Masters

(Keep original copy master with manual)



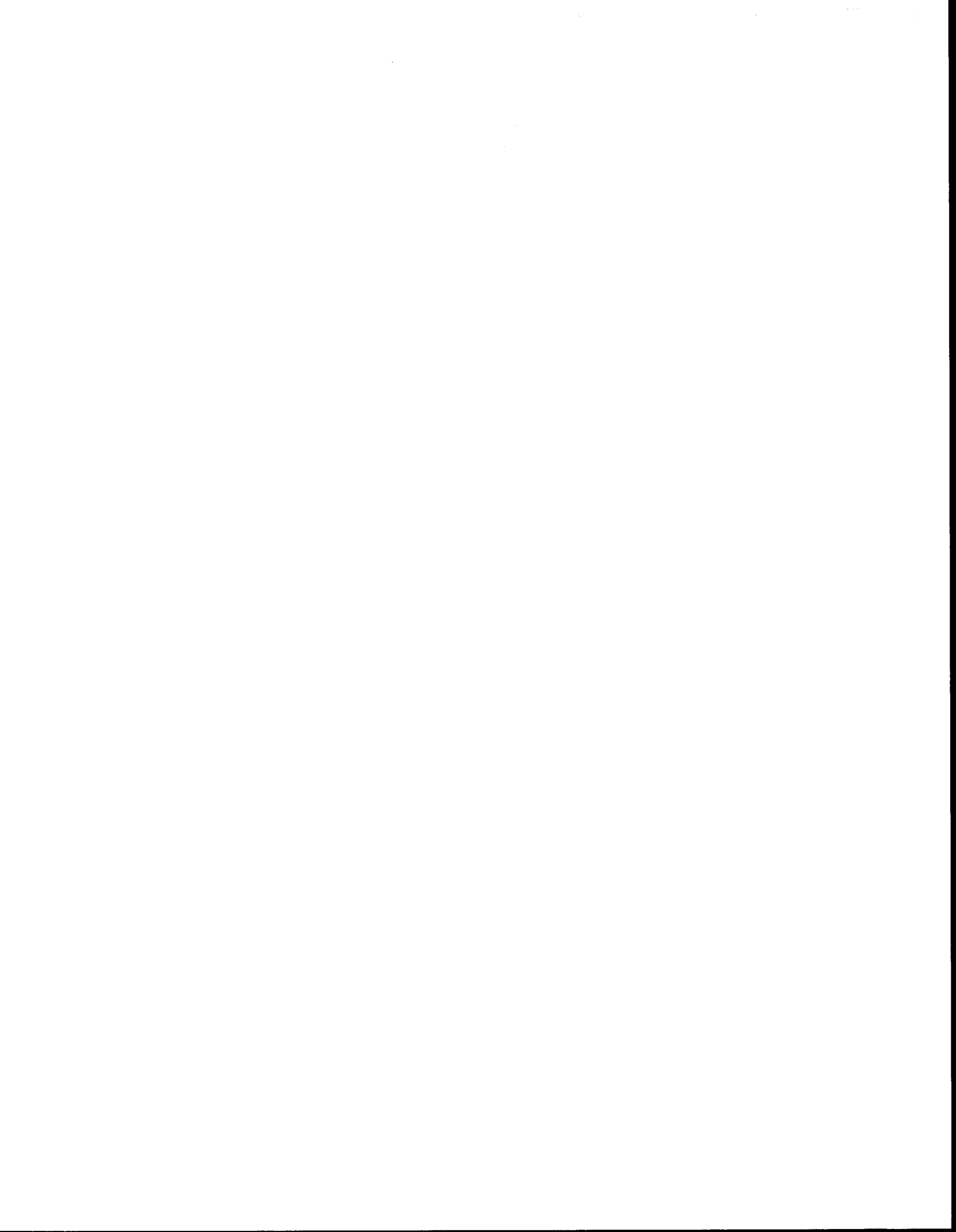



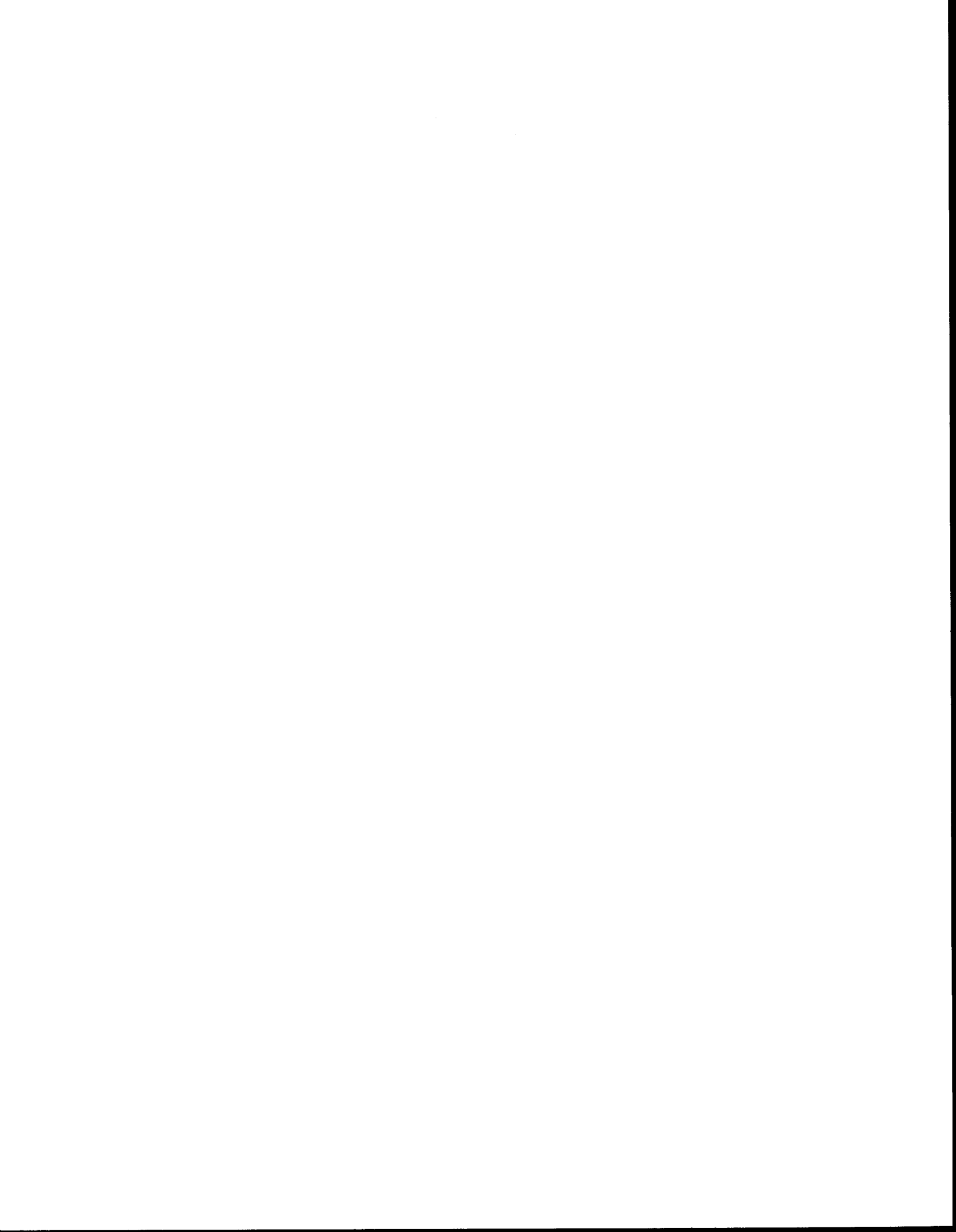

S.G. COMPOSITION SURVEY

SAMPLE COLLECTION

- Riffle Crest
- Patch
- Transect



FORM 6.2

WRIA # _____ Date _____ / _____ / _____
 Unlisted Trib RB LB Segment # _____ Sub-Segment Code _____

RC/T # _____ Sample # _____ Bucket # _____ + _____ Notes: _____ _____ _____	RC/T # _____ Sample # _____ Bucket # _____ + _____ Notes: _____ _____ _____	RC/T # _____ Sample # _____ Bucket # _____ + _____ Notes: _____ _____ _____	RC/T # _____ Sample # _____ Bucket # _____ + _____ Notes: _____ _____ _____
RC/T # _____ Sample # _____ Bucket # _____ + _____ Notes: _____ _____ _____	RC/T # _____ Sample # _____ Bucket # _____ + _____ Notes: _____ _____ _____	RC/T # _____ Sample # _____ Bucket # _____ + _____ Notes: _____ _____ _____	RC/T # _____ Sample # _____ Bucket # _____ + _____ Notes: _____ _____ _____
RC/T # _____ Sample # _____ Bucket # _____ + _____ Notes: _____ _____ _____	RC/T # _____ Sample # _____ Bucket # _____ + _____ Notes: _____ _____ _____	RC/T # _____ Sample # _____ Bucket # _____ + _____ Notes: _____ _____ _____	RC/T # _____ Sample # _____ Bucket # _____ + _____ Notes: _____ _____ _____
RC/T # _____ Sample # _____ Bucket # _____ + _____ Notes: _____ _____ _____	RC/T # _____ Sample # _____ Bucket # _____ + _____ Notes: _____ _____ _____	RC/T # _____ Sample # _____ Bucket # _____ + _____ Notes: _____ _____ _____	RC/T # _____ Sample # _____ Bucket # _____ + _____ Notes: _____ _____ _____



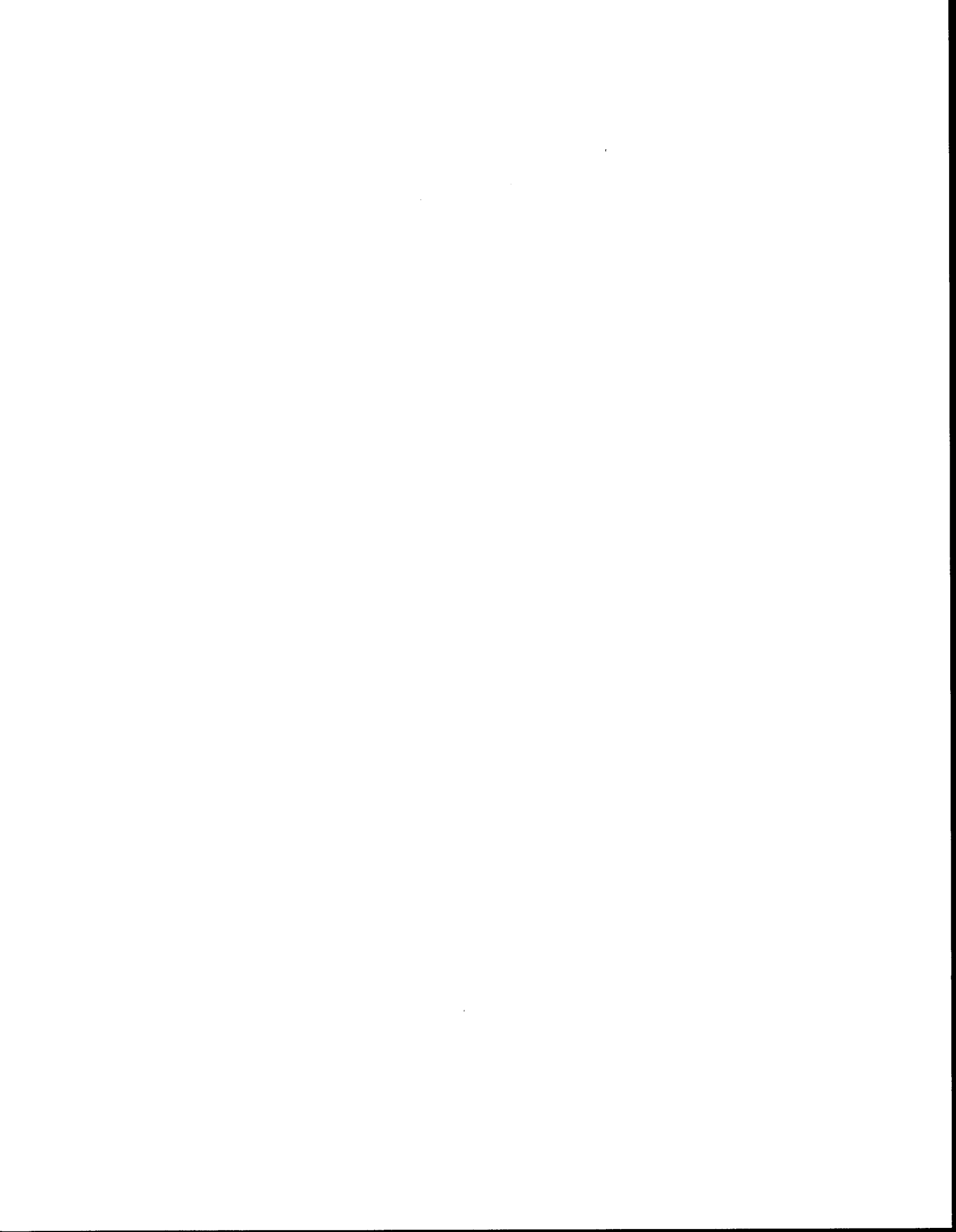

Appendix B

Completed Examples of Forms 6.0, 6.1R, 6.1P, 6.2, and 6.3

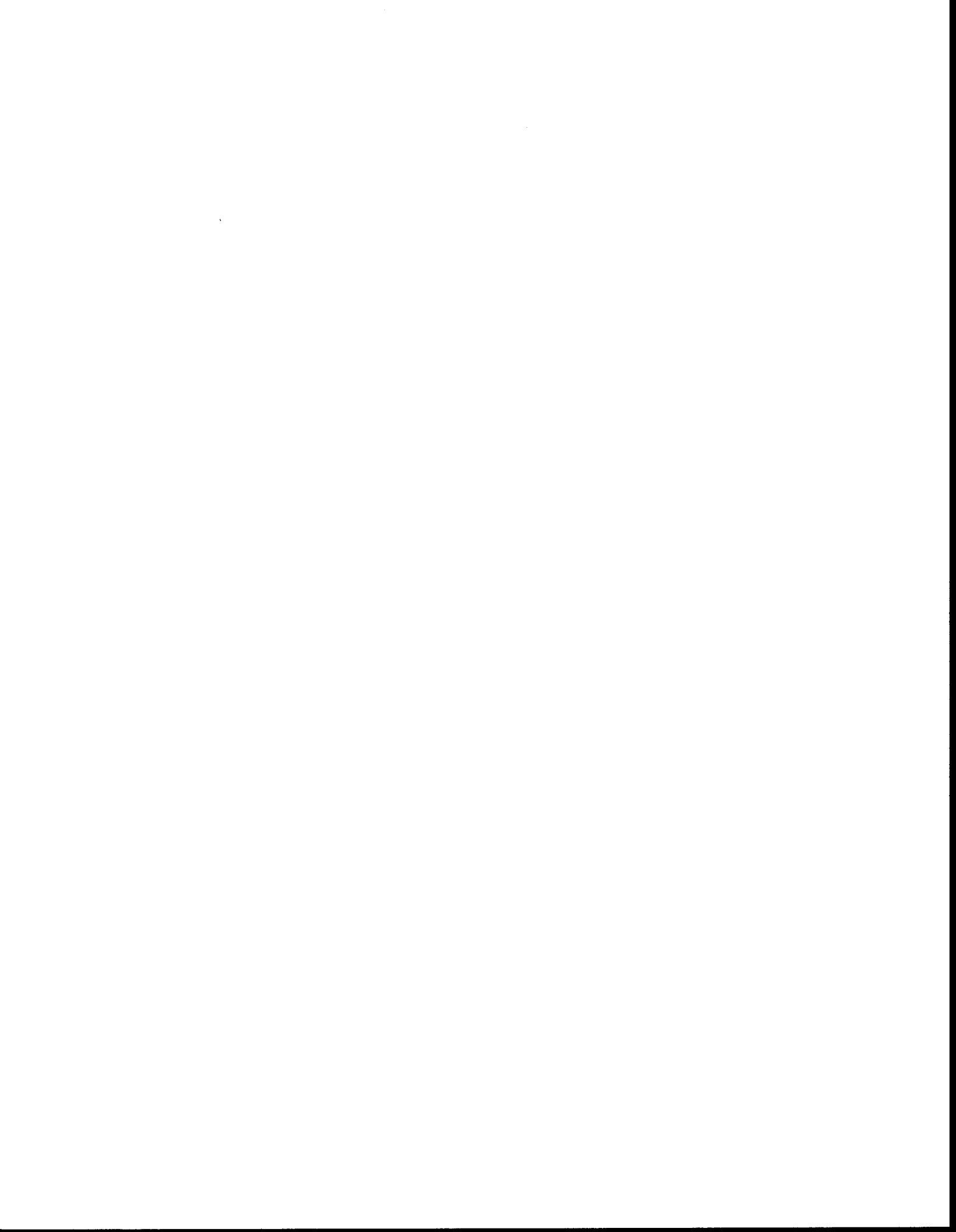



Stream Name PERCIVAL CREEK

TFW Monitoring Program

S.G. COMPOSITION SURVEY

RIFFLE CREST INVENTORY

FORM 6.1R

WRIA # 130029 Unlisted Trib RB LB
 Segment # 2 Sub-Segment Code b
 Date 7/19/98

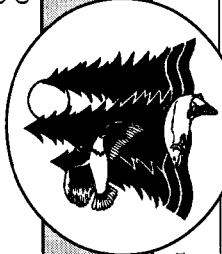

Landmark RP #	Riffle Crest RC #	D/DN	Distance	D/UP	Samples EST #	Chan. Cat. 1-3	Channel Loc. RB/C/LB	SG Dom Sub Size Range	Lrg Sub 100 mm+	Collect. OBS	FIELD NOTES
Ø			Ø								RB = RIGHT BANK LB = LEFT BANK SG = SPANNING GRAVEL RCG = REG CANALY GRASS SOD = SMALL ORGANIC DEBRIS DB = DRY BAR
	1		2		2	2	X	8-32	/	SOD	L. SEGMENT BOUNDARY - RP@ 3M RB CEDAR
	2		12		3	1	X X	8-16	/		BELOW LWD JAM
	3		21		2	1	X	16-64	/	RCG	RCG OVERHANG BOTH BANKS F SAND
	4		36		2	1	X X	32-100	YES	/	JUST DOWNSTREAM OF LEANING CEDAR
	5		67		3	1	X X X	16-64	/	/	LOOKS GOOD!
	6		71		1	2	X	8-16	/	/	CHANNEL SEPARATED BY DB
	7		92		1	2	X	32-64	/	SOD	" " "
RP#1			103								RP#1 RB ON ALDER
	8		105		3	1	X X X	16-64	YES	/	SOME 100' MIXED / POOL FORMED BY ROOTWAD
BRIDGE		117	167	192							167-50 = 117 FOOT BRIDGE W/ CEMENT SUPPORTS 167+25 = 192 W/IN BFC
RP#2			201								RP#2 LB ON D. FIR
	9		211		1	2	X	8-32	/	LWD	
	10		223		3	1	X X	8-64	/	/	SAND DOM LB
	11		234		2	1	X	16-64	/	/	SAND DOM LB/RB
	12		276		1	2	X	8-32	/	/	SMALL CHANNEL SEPARATED BY DB
	13		295		2	1	X X	64-100	YES	/	BELOW PLUNGE POOL

Ⓢ CONT. NEXT PAGE





FORM 6.1P

Stream Name PERCIVAL CREEK

PATCH INVENTORY

METERS
 FEET

S.G. COMPOSITION SURVEY

WRIA # 130029 Unlisted Trb RB LB Segment # 7 Date 7/28/98

Landmark RP #	Patch P #	Unit Length	Trans T #	D/DN	Distance	D/UP	Samples EST #	Chan. Cat. 1-3	Channel Loc. RB/C/LB	SG Dom Sub Size Range	Lrg Sub 100 mm+	Collect. OBS	FIELD NOTES
Ø					Ø								LWR SEGMENT BOUNDARY RP RB @ 2m D-FIR RP LB @ 4m ALDER
	1	6.0	1	12.0	^{1.9} 13.0	18.0	2	2	X	32-100	YES	/	UPPER RIFFLE
			2		^{3.9} 15.0		3	1	X X	32-96	YES	/	TRANSECT ALONG RIFFLE CREST
			3		^{5.9} 17.0		1	2	X	16-32	/	/	SIDE of POOL
	2	1.0	4	14.0	^{0.9} 14.5	15.0	1	2	X	8-32	/	/	DOWNSTREAM of LWD
	3	3.5	5	23.5	^{0.9} 24.4	27.0	2	2	X	8-64	/	/	RIFFLE
			6		^{3.6} 26.1		2	2	X	8-64	/	/	"
BRIDGE		75.0		31.0	81.0	108.0	/						BUFFER 50m/DN + 25m/UP
					101								RP#1 RB @ 3m CEDAR
	4	24.0	7	108.0	^{3.1} 111.1	132.0	2	1	X X	32-64	/	/	LONG RIFFLE
			8		^{9.1} 117.1		3	1	X X X	8-64	/	LWD	SMALL LWD SPANS TRANSECT
			9		^{15.1} 123.1		2	2	X X	32-100	YES	Boulder	
			10		^{19.9} 127.9		1	2	X	8-16	/	/	SG TAPERS AT TOP
	5	3.0	11	147.0	^{0.8} 147.8	150.0	1	3	X	8-32	/	LWD	SIDE CHANNEL
			12		^{2.3} 149.3		2	3	X X	16-64	/	/	
	6	7.5	13	208	^{1.3} 209.3	215.5	1	3	X	8-32	/	LWD	
			14		^{3.8} 211.8		1	3	X	8-32	/	LWD	GO TO NEXT PAGE



S.G. COMPOSITION SURVEY

SAMPLE COLLECTION

- Rifle Crest
- Patch
- Transect



FORM 6.2

WRIA # 130029

Unlisted Tnb RB LB

Segment # 2

Sub-Segment Code 6

Date 7/21/98

RC/T # 3 2 Bucket Sample
 Sample # 1
 Bucket # 12 + _____
 Notes: RCG BOTH BANKS - NO ROOTS IN SG - EASY CORE

RC/T # 7 2 Bucket Sample
 Sample # 2
 Bucket # 16 + _____
 Notes: 2 ATTEMPTS DUE TO BURIED OBS.

RC/T # 7 2 Bucket Sample
 Sample # 3
 Bucket # 02 + _____
 Notes: NO PROBLEM

RC/T # 7 2 Bucket Sample
 Sample # 4
 Bucket # _____ + _____
 Notes: HIT BURIED OBS - NO MORE UNDISTURBED SG

RC/T # 11 2 Bucket Sample
 Sample # 4
 Bucket # 21 + _____
 Notes: GOOD CORE - SOME WOOD PIECES IN SAMPLE

RC/T # 11 2 Bucket Sample
 Sample # 5
 Bucket # 17 + _____
 Notes: GOOD CORE

RC/T # 15 2 Bucket Sample
 Sample # 6
 Bucket # 101 + _____
 Notes: 2 ATTEMPTS - BURIED OBS.

RC/T # 15 2 Bucket Sample
 Sample # 7
 Bucket # 79 + _____
 Notes: NO PROBLEM

RC/T # 15 2 Bucket Sample
 Sample # 8
 Bucket # 32 + _____
 Notes: DIFFICULT CORE - LRG PARTICLES IN SAMPLE

RC/T # 19 2 Bucket Sample
 Sample # 9
 Bucket # 24 + _____
 Notes: LOTS OF WATER

RC/T # 19 2 Bucket Sample
 Sample # 10
 Bucket # 25 + 14
 Notes: DEEP PART OF RC - NEEDED 2 BUCKETS

RC/T # 23 2 Bucket Sample
 Sample # 11
 Bucket # 18 + _____
 Notes: EASY

RC/T # 23 2 Bucket Sample
 Sample # 2
 Bucket # AB + _____
 Notes: 2 - ATTEMPTS/NO SAMPLE DUE TO BURIED OBS. COIN TOSS: HEADS - GO TO RC 22 * TAILS - GO TO RC 21

RC/T # 22 2 Bucket Sample
 Sample # 12
 Bucket # 96 + _____
 Notes: ONLY ONE EST. SAMPLE - NO PROBLEM

RC/T # _____ 2 Bucket Sample
 Sample # _____
 Bucket # _____ + _____
 Notes: END OF

RC/T # _____ 2 Bucket Sample
 Sample # _____
 Bucket # _____ + _____
 Notes: SURVEY





Appendix C

Standard Field and Vehicle Gear Checklist Copy Master

(Keep original copy master with manual)



✓ **STANDARD FIELD GEAR**

- Field clip board/form holder
- Survey Forms (on waterproof paper)
- Copy of survey methods
- Maps- topographic and road
- Pencils & erasers
- Permanent ink marker
- Calculator
- 150 mm ruler
- Pocket field notebook

- Survey Vest
- Compass
- Safety whistle
- Spring clips (2)
- Vinyl flagging
- Pocket knife/multi-purpose tool

- Backpack or canvas tote bag
- First aid kit
- Water bottle and/or filtration system
- Food/energy bars
- Rain gear
- Leather gloves
- Safety glasses
- Bug repellent
- Sun screen
- Small flashlight or headlamp
- Matches/fire starter
- Emergency blanket
- Snake bite kit (eastern Washington)

✓ **STANDARD VEHICLE GEAR**

- Waterproof plastic tote box
- Backup fiberglass tape
- Comprehensive first aid kit
- Rain tarp
- Rope (100 ft.)
- Extra water
- Extra food
- Extra dry clothes
- Extra batteries

- Spare tire/jack/tire iron
- Tire sealant/inflator
- Tow strap
- Come-along winch
- Fire shovel
- Fire extinguisher
- CB radio (to monitor logging activity)
- Cell phone/VHF radio
- Brush cutter
- Ax/bow saw/chain saw
- Tire chains

✓ For remote work, extra survival & safety gear is recommended.

This gear list is provided as a guideline for outfitting field crews and is not intended to cover all situations. Local conditions may require additional or different gear.

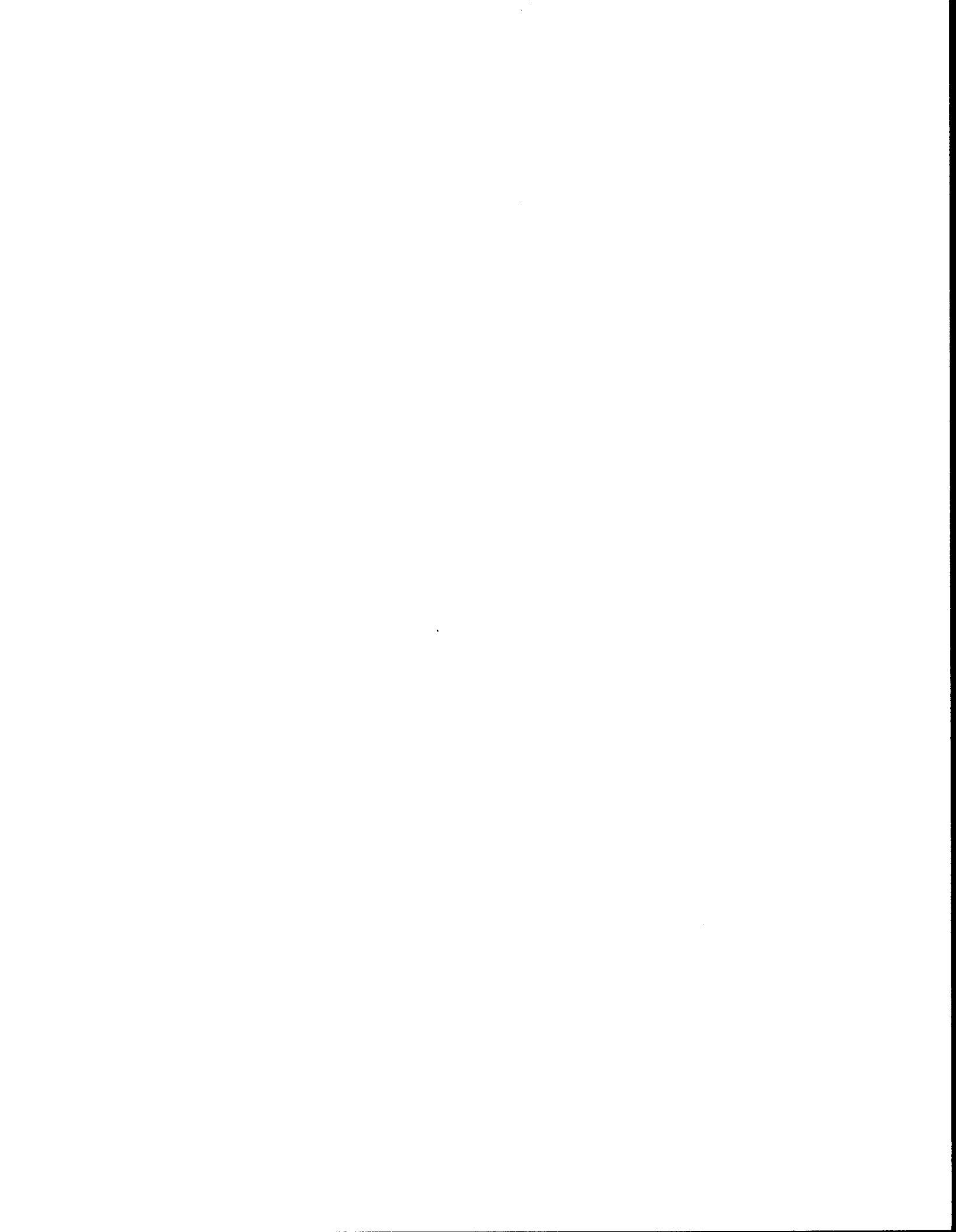

Appendix D

Sample Tracking Slip Copy Master

(Keep original copy master with manual)



Stream Name			
WRIA #		Seg #	O
RC/T #		Date: ___/___/___	2 Bucket Sample
Sample #		Crew Names	Affiliation
Bucket #			

Stream Name			
WRIA #		Seg #	O
RC/T #		Date: ___/___/___	2 Bucket Sample
Sample #		Crew Names	Affiliation
Bucket #			

Stream Name			
WRIA #		Seg #	O
RC/T #		Date: ___/___/___	2 Bucket Sample
Sample #		Crew Names	Affiliation
Bucket #			

Stream Name			
WRIA #		Seg #	O
RC/T #		Date: ___/___/___	2 Bucket Sample
Sample #		Crew Names	Affiliation
Bucket #			

Stream Name			
WRIA #		Seg #	O
RC/T #		Date: ___/___/___	2 Bucket Sample
Sample #		Crew Names	Affiliation
Bucket #			

Stream Name			
WRIA #		Seg #	O
RC/T #		Date: ___/___/___	2 Bucket Sample
Sample #		Crew Names	Affiliation
Bucket #			

Stream Name			
WRIA #		Seg #	O
RC/T #		Date: ___/___/___	2 Bucket Sample
Sample #		Crew Names	Affiliation
Bucket #			

Stream Name			
WRIA #		Seg #	O
RC/T #		Date: ___/___/___	2 Bucket Sample
Sample #		Crew Names	Affiliation
Bucket #			

Stream Name			
WRIA #		Seg #	O
RC/T #		Date: ___/___/___	2 Bucket Sample
Sample #		Crew Names	Affiliation
Bucket #			

Stream Name			
WRIA #		Seg #	O
RC/T #		Date: ___/___/___	2 Bucket Sample
Sample #		Crew Names	Affiliation
Bucket #			

Stream Name			
WRIA #		Seg #	O
RC/T #		Date: ___/___/___	2 Bucket Sample
Sample #		Crew Names	Affiliation
Bucket #			

Stream Name			
WRIA #		Seg #	O
RC/T #		Date: ___/___/___	2 Bucket Sample
Sample #		Crew Names	Affiliation
Bucket #			

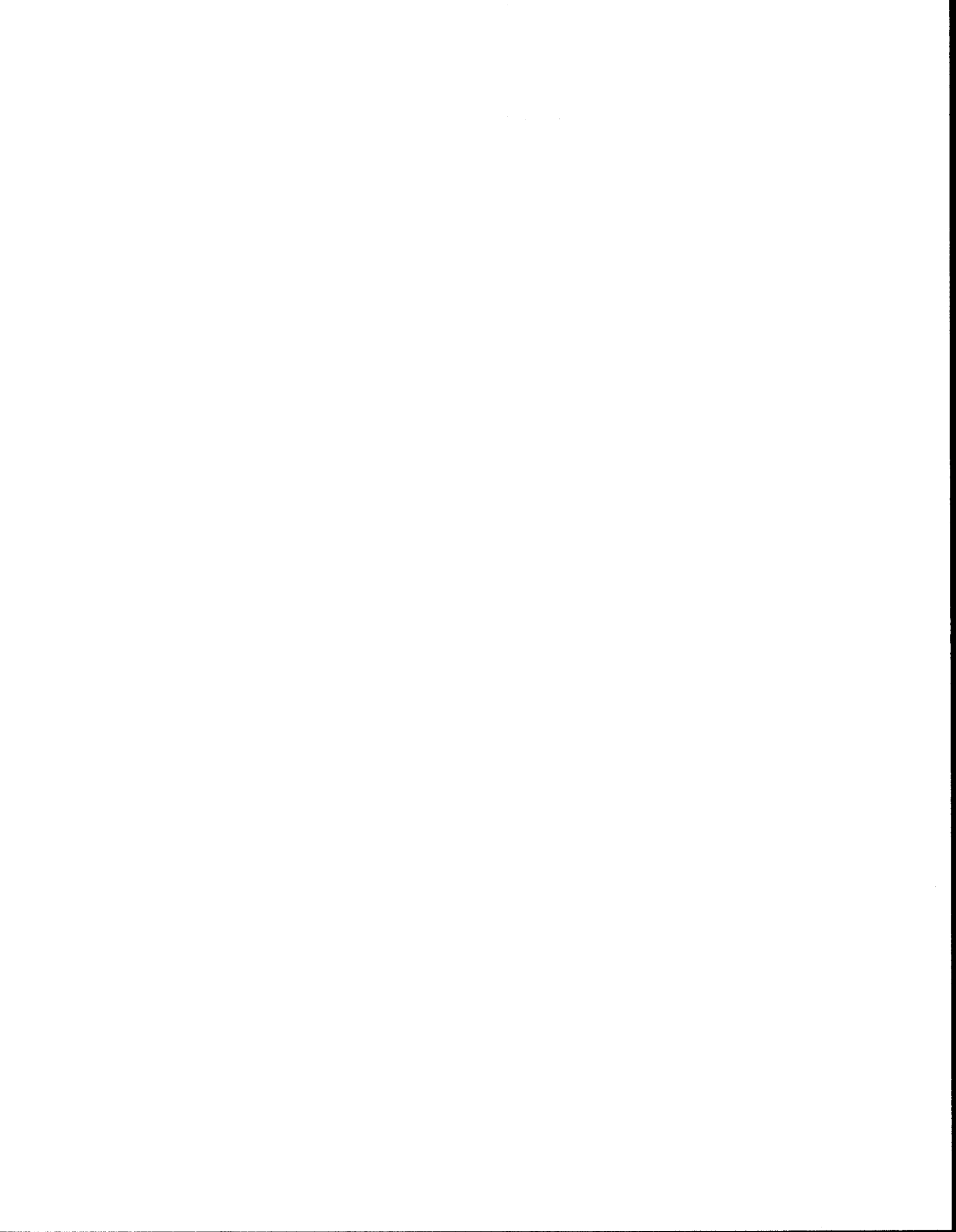

Appendix E

Data Management Examples



TFW Monitoring														
Sediment (Gravel Composition) Survey Header														
wria basin	wria stream	trib segm	sub segm	beginning collection date	end collection date	leader first name	leader last name	leader affiliation	recorder first name	recorder last name	recorder affiliation	sampling field notes	processing begin date	processing end date

processor first name	processor last name	processor affiliation	assistant processor first name	assistant processor last name	assistant processor affiliation	beginning reference point	ending reference point	beginning river mile (mi)	ending river mile (mi)	survey length (m)	survey coverage	survey percentage (%)	processing field notes	



TFW Monitoring												
Sieve Sample (Gravel Composition) Data												
wria	trib	segm	sub	beginning	process	calculated	actual	entry	riffle	sample	field	Sieve
basin	stream	segm	segm	collection	unit	gravel	gravel	date	date		notes	Gravel
				date	(m/g)	density	density					Measure:
												75.00
												26.50
												9.50
												3.35
												2.00
												0.85
												0.106
												0.001





TFW Monitoring

Spawning Gravel Composition Segment Report

Individual Sample Summary

Riffle Crest Number	Sample Number	% Particles < 0.85 mm	Watershed Analysis Rating	Geometric Mean Diameter
24	7	10.41%	GOOD	7.2
24	8	12.13%	FAIR	6.0
24	9	17.95%	POOR	5.0



TFW Monitoring

Spawning Gravel Composition Riffle Report

Stream Name: KENNEDY CREEK WRIA: 14 .0012 .000
 Survey Date: 09/20/1995 to 09/20/1995 Segment: 2 sub: 0
 Processing Date: 10/08/1995 to 10/09/1995
 Reference Points: 4 to 13 River Miles: 0.2 to 0.5
 Survey Length : 915 Survey Coverage:
 Survey Leader: IAN CHILD Affiliation: SQUAXIN ISLAND TRIBE

Percentage of Riffle Crests Rated: GOOD: 50.0% FAIR: 33.3% POOR: 16.7%

Riffle Crest Summary

Riffle Crest Number	# of Samples	Mean % Particles <0.85mm	STD Dev % Particles <0.85mm	Watershed Analysis Rating	Geometric Mean Diameter	STD Dev Geometric Mean Dia.
4	3	16.31%	1.22%	FAIR	6.7	0.9
7	2	18.38%	4.29%	POOR	8.3	1.5
12	3	6.99%	3.20%	GOOD	17.3	2.1
16	3	11.19%	1.00%	GOOD	13.0	2.8
20	3	10.58%	1.52%	GOOD	13.1	3.1
24	3	13.50%	3.95%	FAIR	6.1	1.1



TFW Monitoring

Spawning Gravel Composition Individual Sample Report

Stream Name: KENNEDY CREEK WRIA: 14.0012 .000
Survey Date: 09/20/1995 to 09/20/1995 Segment: 2 sub: 0
Processing Date: 10/08/1995 to 10/09/1995

Reference Points: 4 to 13 River Miles: 0.2 to 0.5
Survey Length: 915 Survey Coverage:
Survey Leader: IAN CHILD Affiliation: SQUAXIN ISLAND TRIBE

Riffle Crest (RC) Number: 4

Sample Number: 15

Individual Sample Summary

Percentage of Particles Less Than 0.85 mm (Volumetric) = 16.34%

Geometric Mean Diameter (Gravimetric) = 6.6

Individual Sample Data

Sieve Size	Weight (gm)	Volume (ml)	Cumulative % Finer Than (ml)
0.106	40.0	80	0.0%
0.250	115.9	190	2.4%
0.500	186.3	270	8.2%
0.850	329.3	445	16.3%
2.000	336.2	415	29.8%
4.000	473.0	550	42.4%
9.500	832.7	915	59.0%
26.500	413.6	440	86.7%
75.000	0.0	0	100.0%
Total	2,726.9	3,305	344.8%



Appendix F

Random Number Table

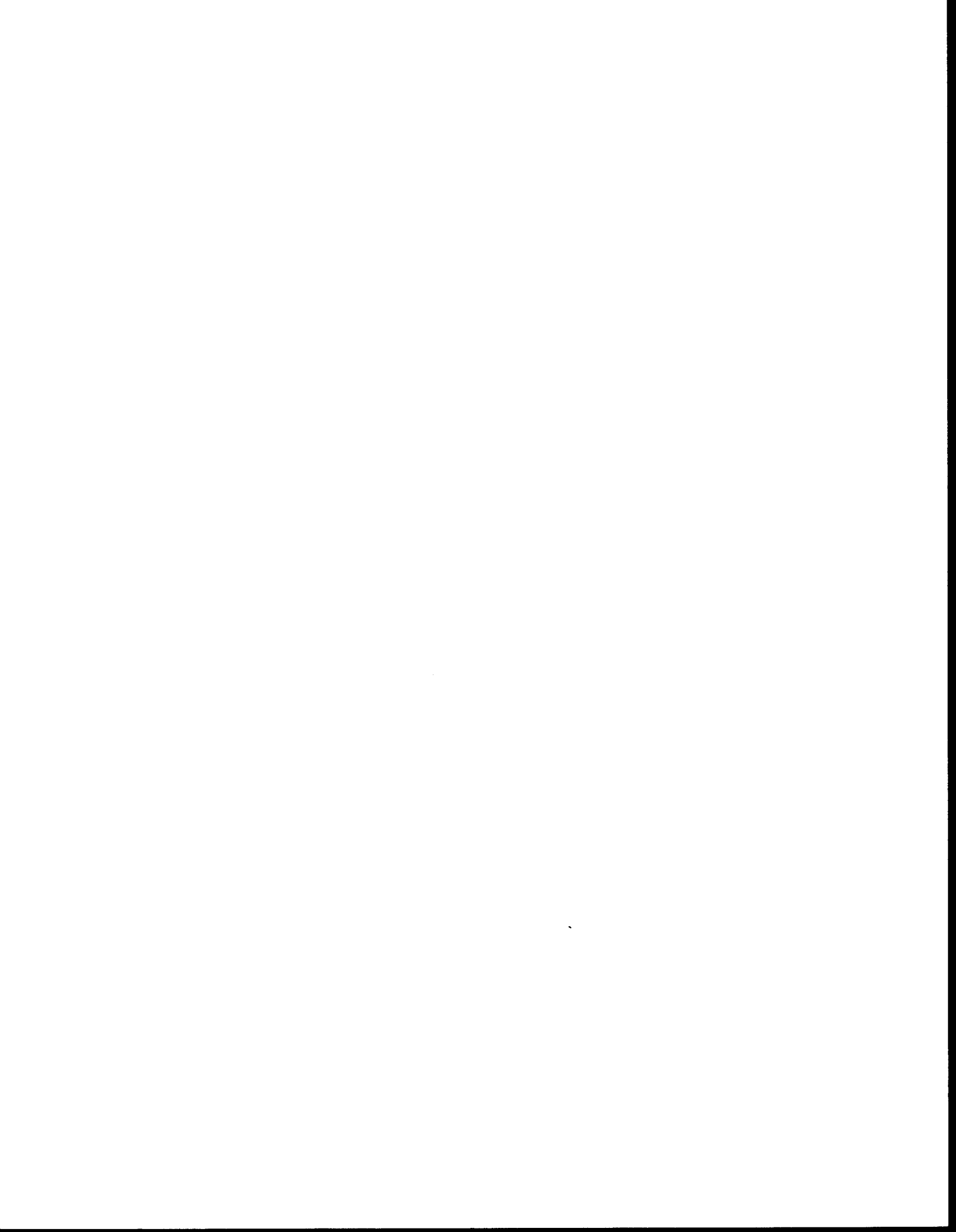

Table of Random Numbers

77	66	88	40	86	61	96	70	78	75	29	77	21	94	12	37	66	11	53	42
74	81	53	71	16	61	59	13	33	02	25	95	92	37	03	18	46	26	37	86
05	88	20	12	10	45	80	22	38	70	94	11	22	02	08	37	74	87	49	04
05	79	76	95	69	00	48	70	60	14	53	11	06	57	06	26	60	31	06	74
79	98	70	98	97	94	55	99	44	04	75	89	69	50	64	03	96	68	17	89
55	09	79	15	11	56	65	88	08	16	96	95	33	17	60	45	81	31	50	46
79	19	16	49	99	08	80	01	56	35	41	42	72	58	20	39	33	53	85	26
28	70	12	06	71	02	34	50	30	16	83	58	39	98	84	01	27	85	17	35
54	44	53	59	34	44	49	93	61	75	19	87	34	93	85	16	18	79	65	94
93	69	31	43	93	93	77	39	72	40	66	32	90	86	65	88	41	19	36	86
24	94	65	41	64	64	95	13	46	97	43	12	86	02	79	50	67	90	14	19
04	07	67	01	59	03	27	37	83	20	17	82	11	80	46	08	32	68	60	26
67	24	63	38	76	53	29	14	02	47	70	31	20	88	24	31	14	65	23	35
69	06	90	51	48	94	89	77	41	66	54	60	66	95	46	73	76	59	20	05
66	56	20	91	61	48	91	73	98	80	96	94	45	09	93	21	90	40	03	01
36	48	02	01	88	94	20	08	07	64	08	84	26	41	25	54	43	65	82	24
62	93	85	57	12	06	07	88	22	37	03	84	80	69	93	29	22	34	67	88
94	01	05	57	71	98	47	26	58	99	72	11	69	93	22	46	72	52	75	62
52	94	18	97	82	49	76	84	86	83	05	27	53	27	16	40	94	34	81	86
27	43	78	39	71	17	16	72	43	37	60	73	83	41	31	32	61	05	37	89
46	00	19	71	63	06	75	27	01	57	59	61	86	70	33	35	54	77	81	38
29	58	01	44	39	62	83	16	97	46	31	27	27	43	67	66	35	08	86	34
19	31	80	79	63	47	80	56	00	71	06	17	49	70	26	75	55	43	46	84
02	52	31	23	74	12	16	62	21	19	76	63	33	43	17	16	96	00	42	50
06	00	13	63	57	37	51	83	45	58	21	01	02	89	88	07	74	32	21	87

Directions for randomly choosing a number between 1 and 8

Enter the table in a random manner by closing your eyes and placing a pencil tip or other pointed object somewhere on the table. If the pencil tip does not touch a number, repeat the process until it does. If the two-digit number is between 01 and 08, the number selected is the one applied to the systematic random sampling strategy. If the number is greater than 08, use the right-hand digit as your selection. If the number ends in a 9, repeat the random selection process until a number in the proper selection range is selected.





